

# OPERATION AND MAINTENANCE MANUAL

## TRANSFER SWITCH NETWORK ANNUNCIATOR

### ZNET900A, ZNET900B AND ZNET901

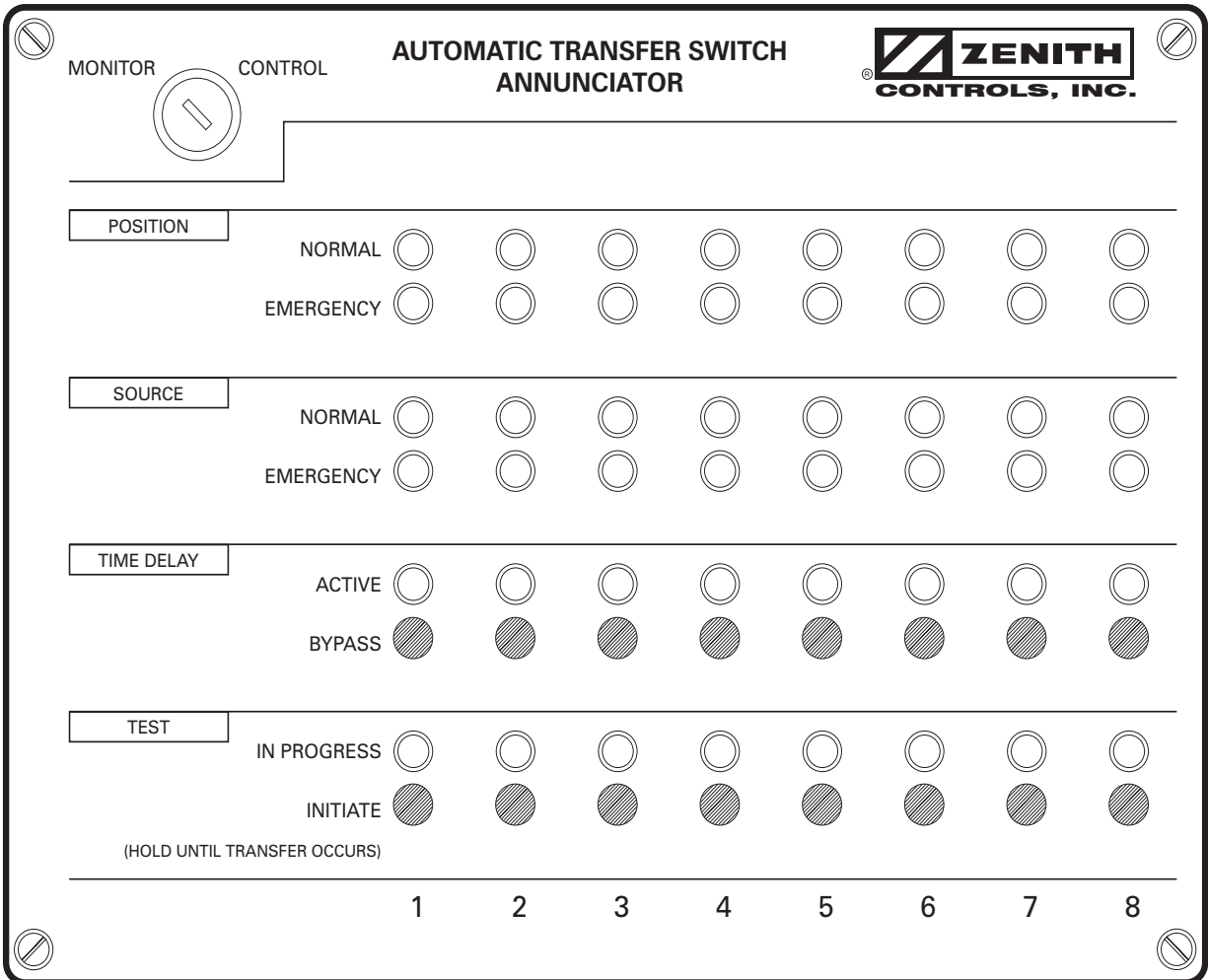

# Table of Contents

	<b>Page</b>
Overview and Features .....	1
Installation .....	2
ZNET900(A/B) Annunciator .....	2
ZNET901 Expansion Unit for Annunciation .....	3
Topology.....	4
Singly Terminated Network (Daisy Chain) .....	4
Doubly Terminated Network (Backbone with Drops) .....	4
User Settings .....	5-6
Dip Switch Designations .....	5-6
Maintenance and Testing .....	7
Troubleshooting .....	7

# Overview and Features

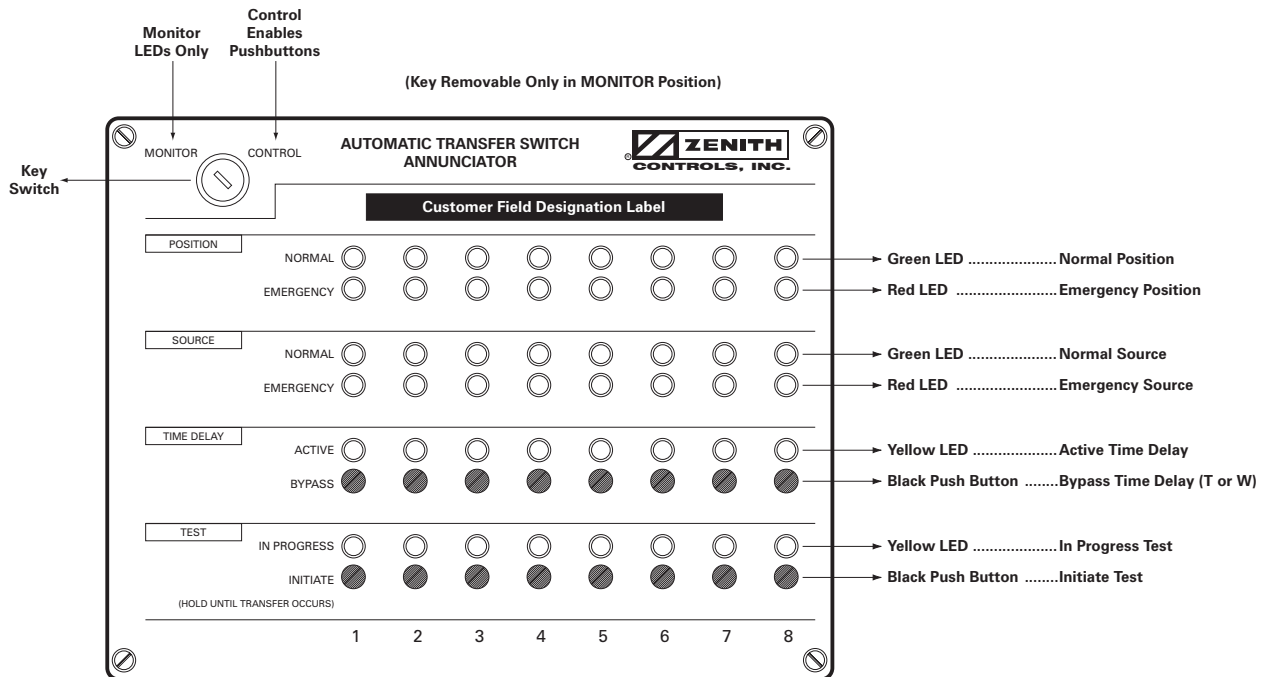

## KEY SWITCH —

The **MONITOR** position allows operation of LEDs only. *(Key can be removed in this position)* The **CONTROL** position allows operation of LEDs and the pushbuttons. *(Key cannot be removed in this position)*

## POSITION — Normal LED (Green)

Indicates that the corresponding Transfer Switch load is connected to the Normal source.

## POSITION — Emergency LED (Red)

Indicates that the corresponding Transfer Switch load is connected to the Emergency source.

## SOURCE — Normal LED (Green)

Indicates that the corresponding Transfer Switch has an acceptable Normal source.

## SOURCE — Emergency LED (Red)

Indicates that the corresponding Transfer Switch has an acceptable Emergency source.

## TIME DELAY — Active LED (Yellow)

This flashing LED indicates that the corresponding Transfer Switch has a timer functioning. Timers monitored includes all timers associated with delaying transfer in either direction. **Note:** Not available in closed transition mode.

## TIME DELAY — Bypass Push Button

Will instantaneously lapse T or W timer whichever is timing concurrent with pushbutton activation. *(Key Switch must be in the Control position)* **Note:** Not available in closed transition mode.

## TEST — In Progress LED (Yellow)

Indicates the corresponding Transfer Switch is in a test mode. Indication will occur whether the test is initiated at the annunciator or locally at the ATS.

## TEST — Initiate Push Button

Begins a test sequence (power loss simulation) but must be held until transfer occurs. Transfer is complete once the Emergency Position and Emergency Source LEDs are both illuminated. Releasing before test is complete will cancel the test. *(Key Switch must be in the Control position)*

# Installation

## ZNET900(A/B) Annunciator

1. Remove cover panel (see Figure below).
2. Mount unit to wall.
3. Connect network connection as shown.
4. Connect power input as shown.
5. Reinstall cover.

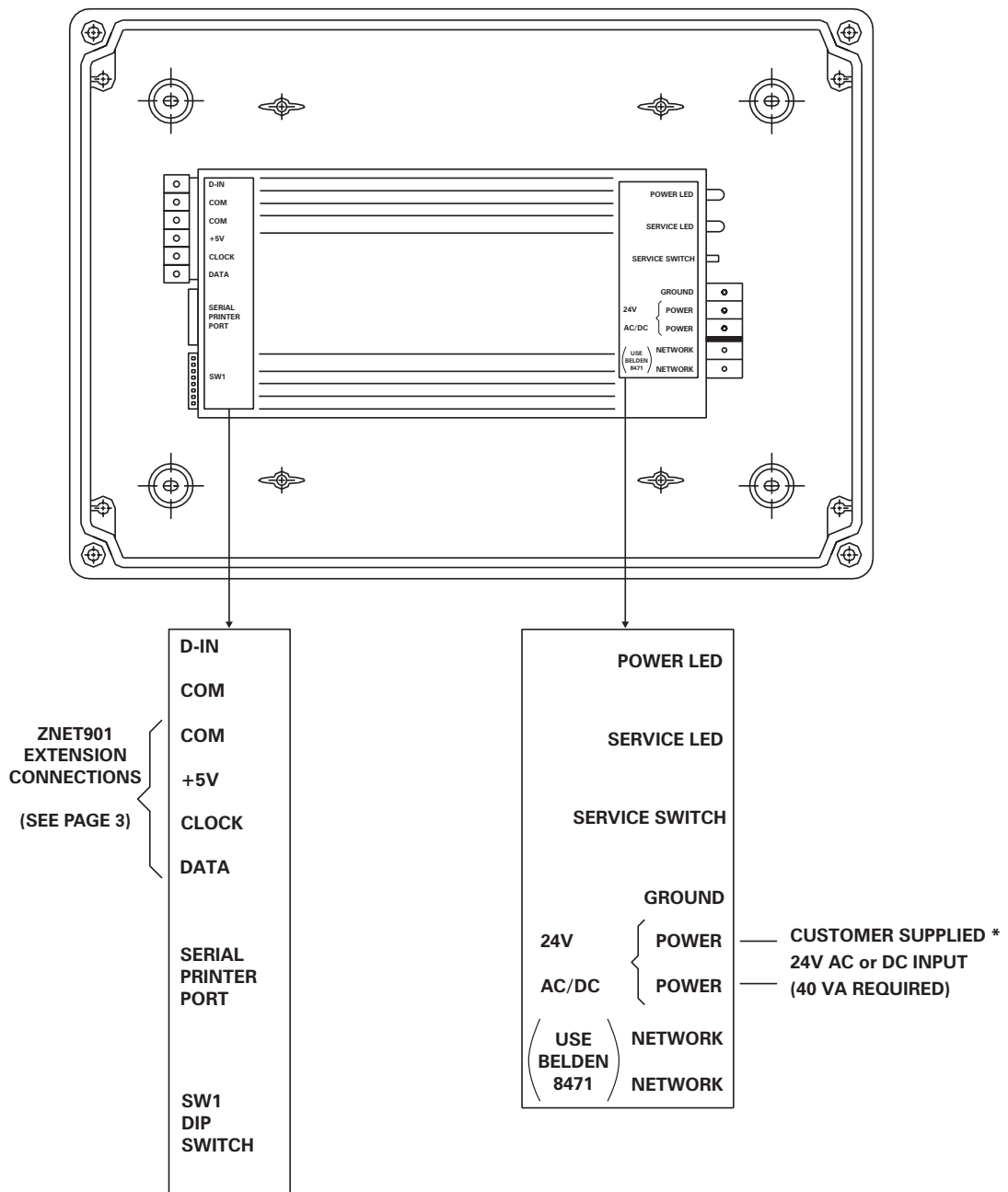

\* Adapters Available - Contact Factory

# Installation *(cont'd)*

## ZNET901 Extension Unit for Annunciator

1. Remove cover panel (see Figure below).
2. Mount extension unit no further than 2' - 0" (two feet) from ZNET900(A/B).
3. Connect extension unit to ZNET900(A/B) by wiring the 4 wires to the slots designated for COM, 5VDC, clock and data. Be sure to match the wire colors.
4. Reinstall cover.

**NOTE:** Extension unit does not require network or power connections.

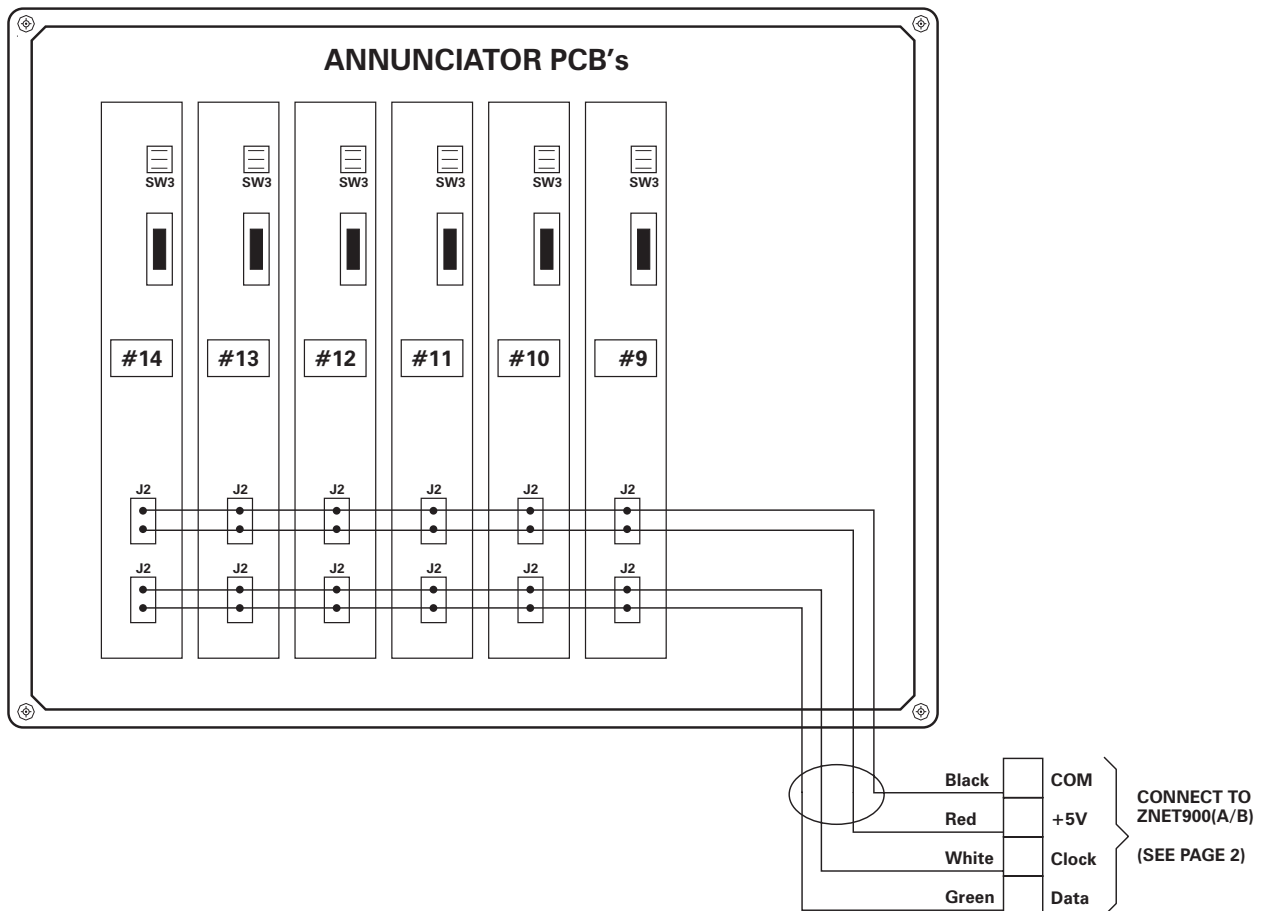

# Topology

## Singly Terminated Network (Daisy Chain)

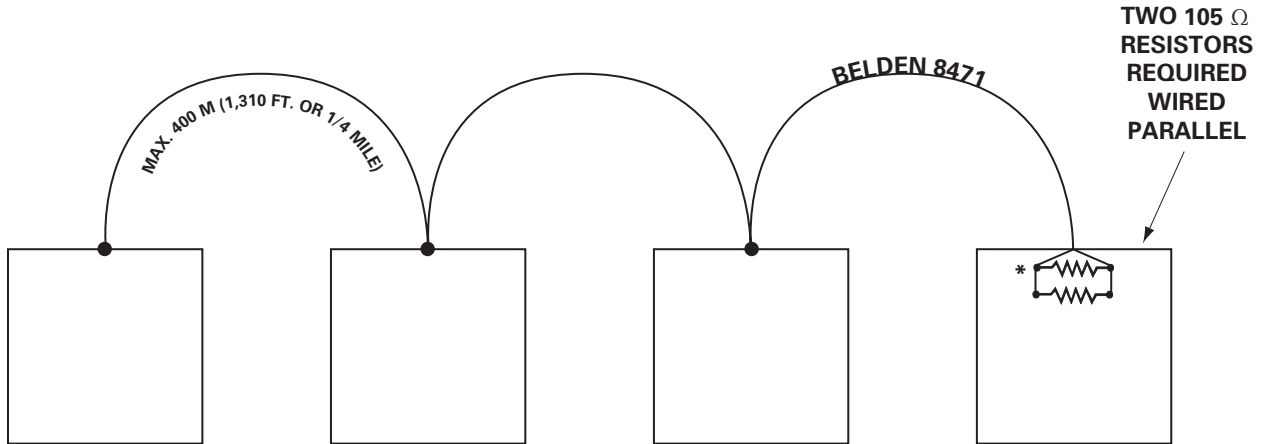

**MAXIMUM TOTAL NETWORK CABLE LENGTH: 500 M (1,640 FT.)**

\* TWO RESISTORS PROVIDED WITH ANNUNCIATOR

## Doubly Terminated Network (Backbone with Drops)

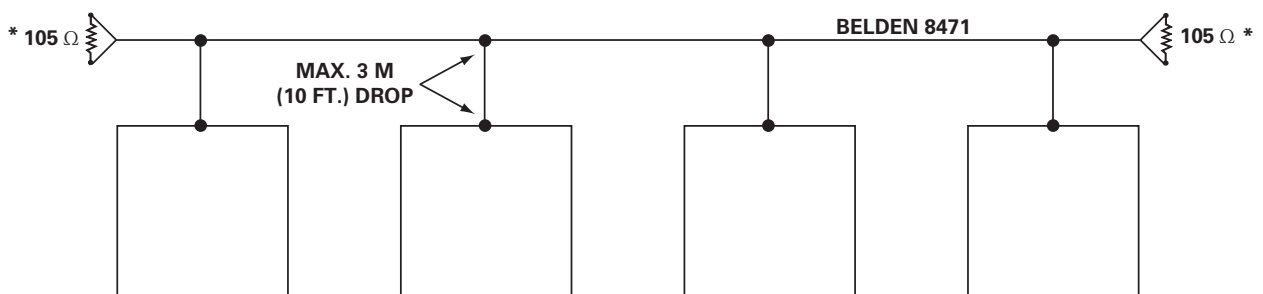

**MAXIMUM TOTAL LENGTH: 2,700 M (8,850 FT. OR 1.7 MILES)**

\* TWO RESISTORS PROVIDED WITH ANNUNCIATOR

# User Settings

## DIP Switch Designations

**NOTE:** This setting is necessary only if optional printer is used.

Entry of the time and date values for the clock/calendar are entered via the 8-position DIP switch SW1 (see Page 2). The service push button switch is used to trigger the data entry. The sequence of operations is as follows:

1. Record the current settings of the DIP switches.

	<b>8</b>	<b>7</b>	<b>6</b>	<b>5</b>	<b>4</b>	<b>3</b>	<b>2</b>	<b>1</b>
<b>ON</b>								
<b>OFF</b>								

2. Set switches 8 thru 4 OFF and 3 thru 1 ON. Press the service switch. The printer will print the message "Start clock-calendar set."
3. Set switches 3 thru 1 according to the following table to set different fields. Switches 8 thru 4 are set to the value of the field in binary code. Press the service switch. The printer will print a message with the field name and the value. It is only necessary to set those fields which need to be changed.

	<b>SW3</b>	<b>SW2</b>	<b>SW1</b>
High digit of the Year (0-9)	OFF	ON	ON
Low digit of the Year (0-9)	ON	OFF	ON
Month (01-12)	OFF	OFF	ON
Date (01-31)	ON	ON	OFF
Hour (00-24)	OFF	ON	OFF
High digit of the Minute (0-5)	ON	OFF	OFF
Low digit of the Minute (0-9)	OFF	OFF	OFF

# User Settings *(cont'd)*

## DIP Switch Designations *(cont'd)*

The setting of the switches 8 thru 4 for different values shown on the right:

4. Set switches 8 thru 4 OFF and 3 thru 1 ON. Press the service switch. The entered values are loaded into the real-time clock/calendar. The printer will print the message "End clock/calendar set."
5. Restore DIP switches to the original settings recorded in the first step.

**NOTE:** The DIP switches (switch 4 through switch 8) are also used to set the annunciator ID which printed out in the event log in all the messages. The ID values (0 through 31) are set as indicated in the table on the right. The ID value is read only upon power up of the unit and therefore changing the DIP switch settings during the clock/calendar setting does not affect the ID number. However, the switches should be returned to their original settings after completing the clock/calendar set procedure so that the original ID setting is not affected.

	SW8	SW7	SW6	SW5	SW4
0	OFF	OFF	OFF	OFF	OFF
1	ON	OFF	OFF	OFF	OFF
2	OFF	ON	OFF	OFF	OFF
3	ON	ON	OFF	OFF	OFF
4	OFF	OFF	ON	OFF	OFF
5	ON	OFF	ON	OFF	OFF
6	OFF	ON	ON	OFF	OFF
7	ON	ON	ON	OFF	OFF
8	OFF	OFF	OFF	ON	OFF
9	ON	OFF	OFF	ON	OFF
10	OFF	ON	OFF	ON	OFF
11	ON	ON	OFF	ON	OFF
12	OFF	OFF	ON	ON	OFF
13	ON	OFF	ON	ON	OFF
14	OFF	ON	ON	ON	OFF
15	ON	ON	ON	ON	OFF
16	OFF	OFF	OFF	OFF	ON
17	ON	OFF	OFF	OFF	ON
18	OFF	ON	OFF	OFF	ON
19	ON	ON	OFF	OFF	ON
20	OFF	OFF	ON	OFF	ON
21	ON	OFF	ON	OFF	ON
22	OFF	ON	ON	OFF	ON
23	ON	ON	ON	OFF	ON
24	OFF	OFF	OFF	ON	ON
25	ON	OFF	OFF	ON	ON
26	OFF	ON	OFF	ON	ON
27	ON	ON	OFF	ON	ON
28	OFF	OFF	ON	ON	ON
29	ON	OFF	ON	ON	ON
30	OFF	ON	ON	ON	ON
31	ON	ON	ON	ON	ON



# Maintenance and Testing

## Troubleshooting

None of the the LEDs will illuminate:

1. Check power supply for proper connection to annunciator unit. (Power LED inside unit will be illuminated if power supply is connected properly). See Page 1.

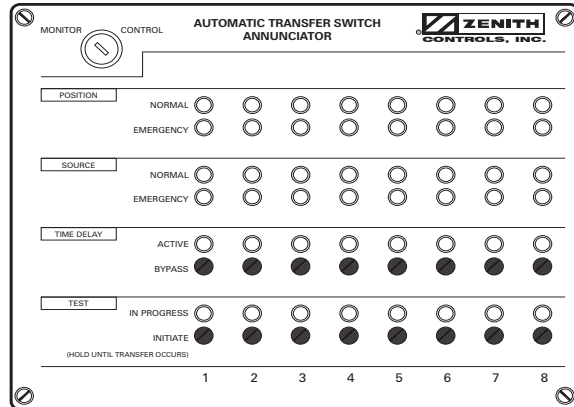

Some of the LEDs not illuminating:

1. Are there less units on the network than there are available slots?
2. Are network terminations on remote ATS units connected?
3. Do all ATS units have power?
4. Do all ATS units have installed network interface cards?

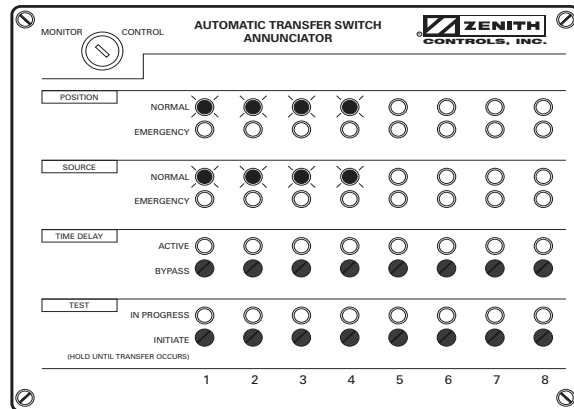

The position and source availability LEDs flash on and off:

1. This indicates that network connections are open between annunciator and corresponding ATS.
2. Are there less units on the network than there are available slots?
3. Are network terminations on remote ATS units connected?
4. Do all ATS units have power?
5. Do all ATS units have network interface cards installed and network cable connected?

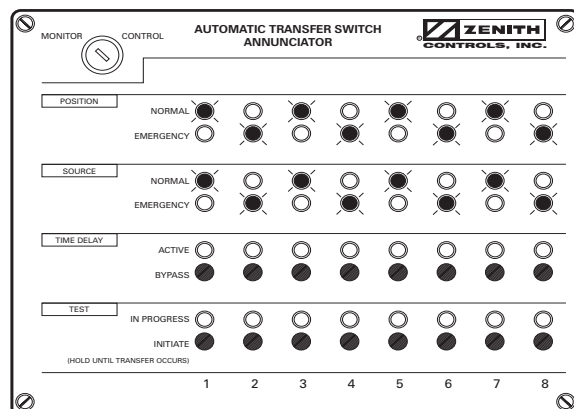



**830 West 40<sup>th</sup> Street  
Chicago, IL 60609 USA**

**Phone: 773 247-6400  
Fax: 773 247-7805**

***www.zenithcontrols.com***  
***E-Mail: zenith@zenithcontrols.com***