

DUAL DIMENSIONS INCHES (ESTIMATING ONLY)  
[MILLIMETERS]

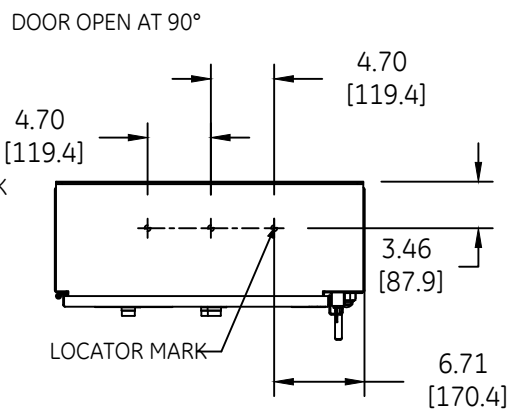
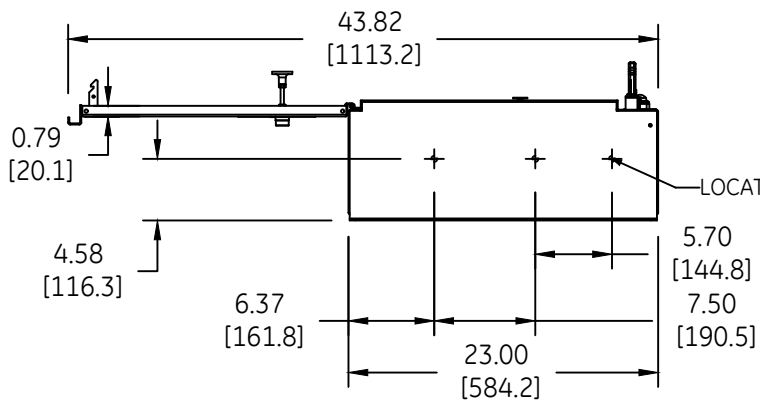
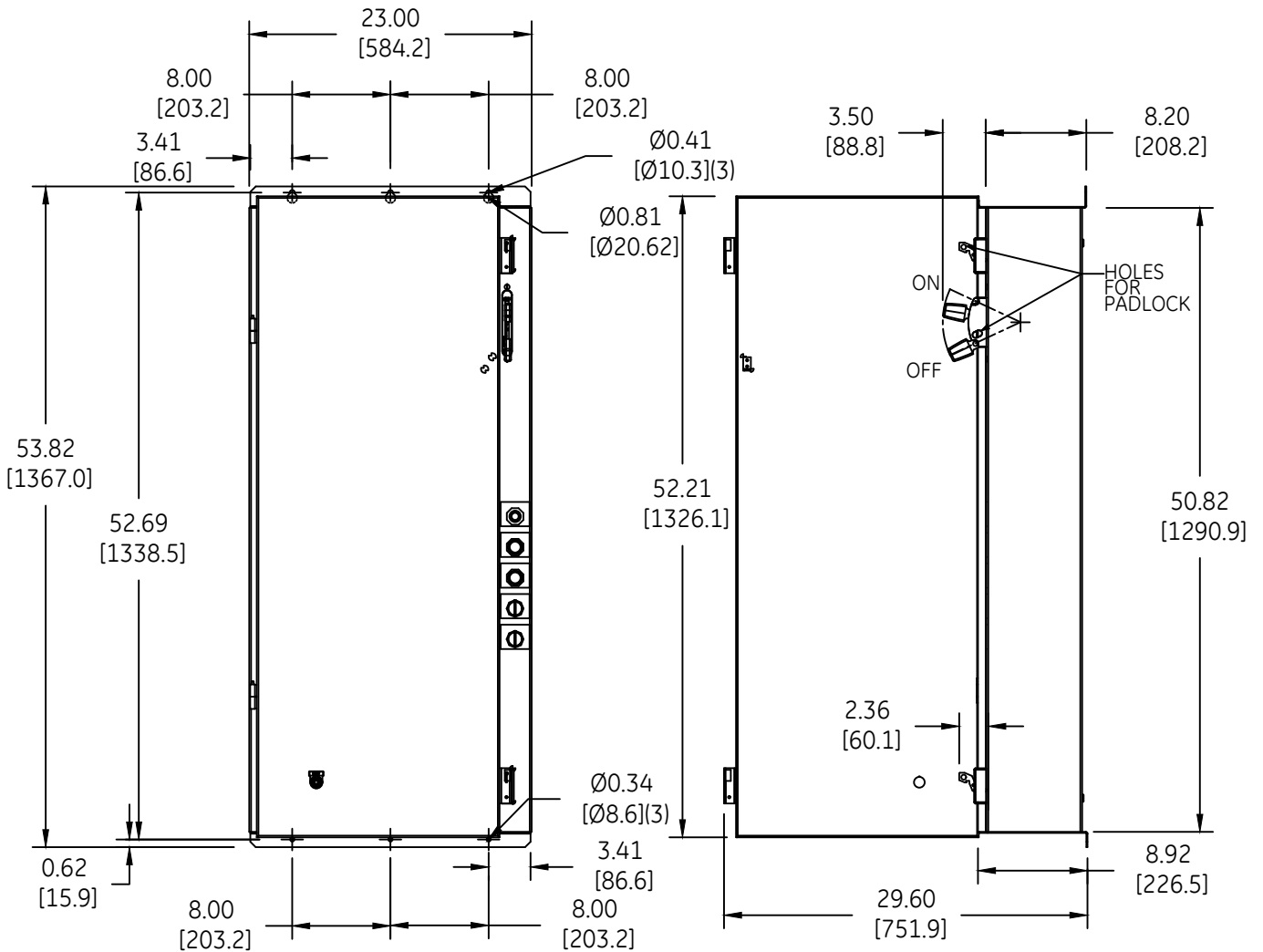

OUTLINE  
TYPE 12/3R ENCLOSED

THIRD ANGLE	SHEET#	DWG NO.	DATE	REV
	1 of 1	270A7150	03/21	05