

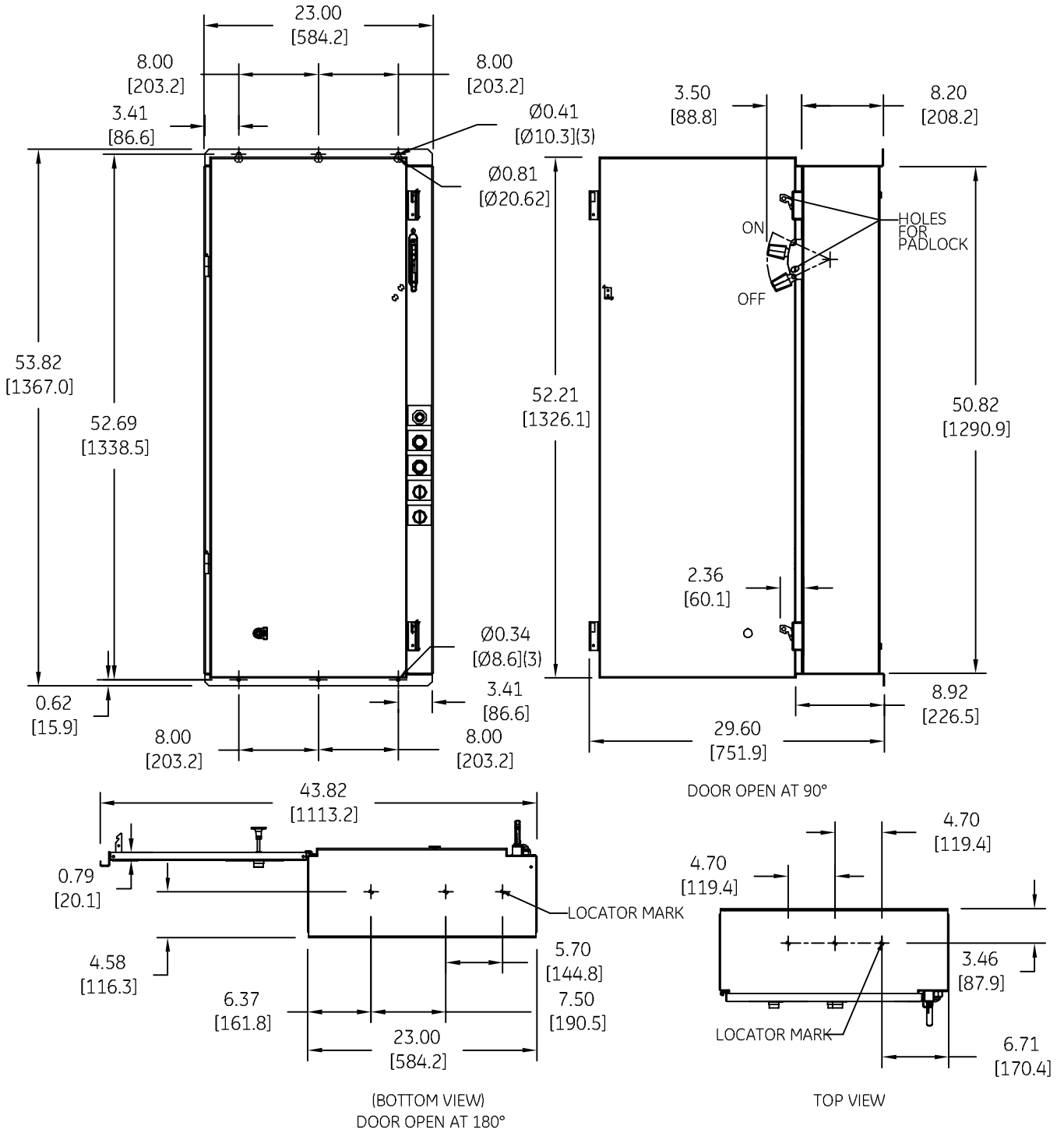

DUAL DIMENSIONS INCHES (ESTIMATING ONLY)  
[MILLIMETERS]



 imagination at work

OUTLINE  
TYPE 12/3R ENCLOSED

DWG NO.	DATE	REV
270A7150	12/19/2009	3

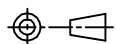
AN #	THIRD ANGLE PROJECTION	SHEET #
BL-0313		1 OF 1