

DUAL DIMENSIONS INCHES (ESTIMATING ONLY)
[MILLIMETERS]

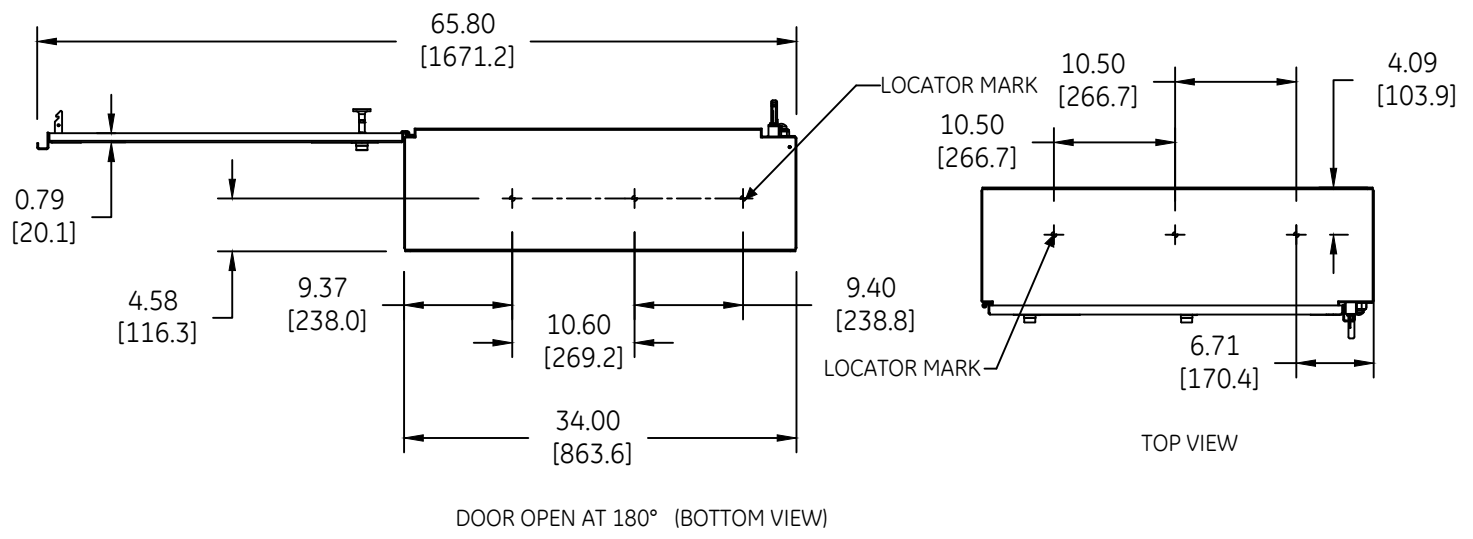
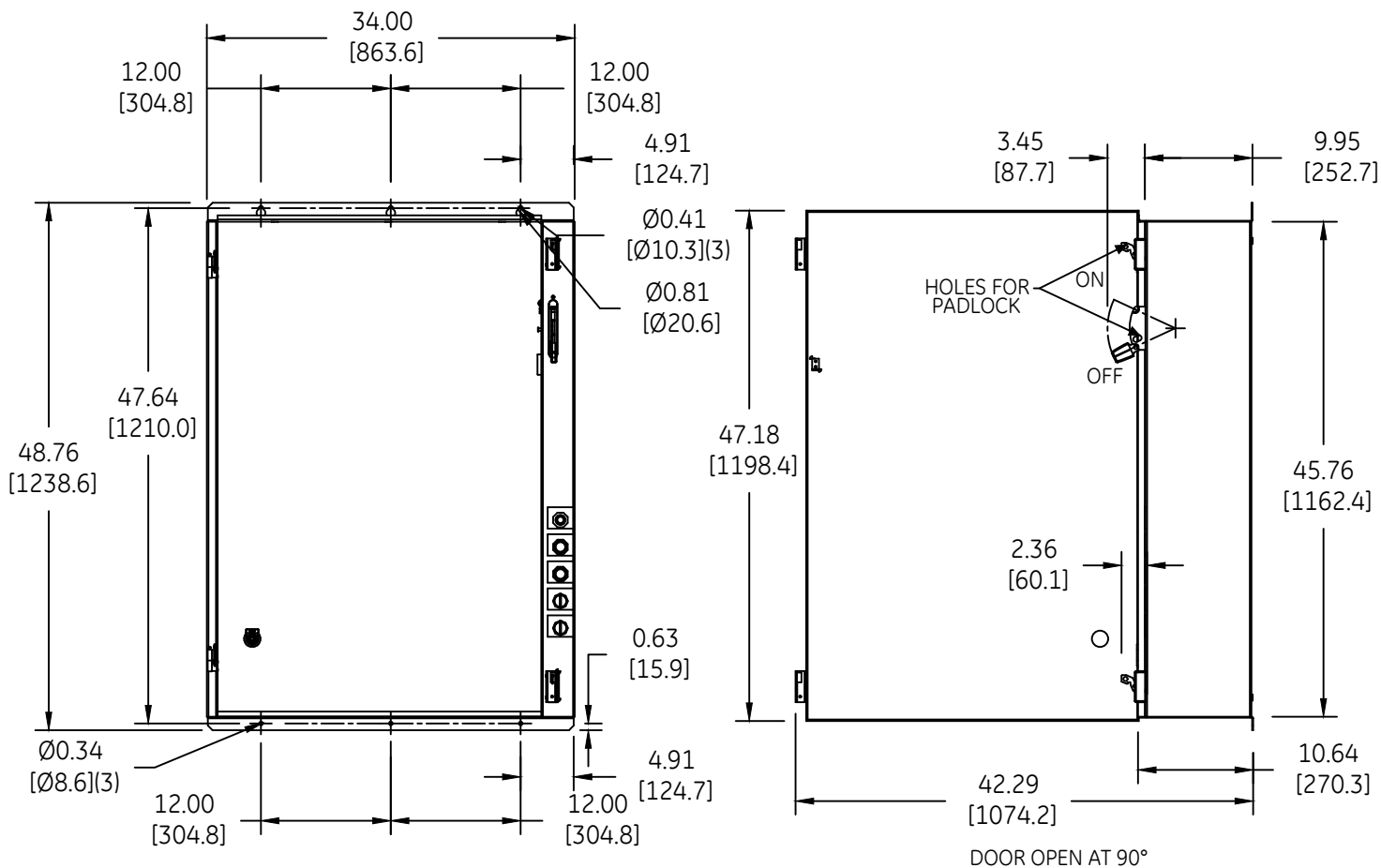

OUTLINE
TYPE 12/3R ENCLOSED

THIRD ANGLE	SHEET#	DWG NO.	DATE	REV
	1 of 1	270A7151	03/21	05