

REAR VIEW

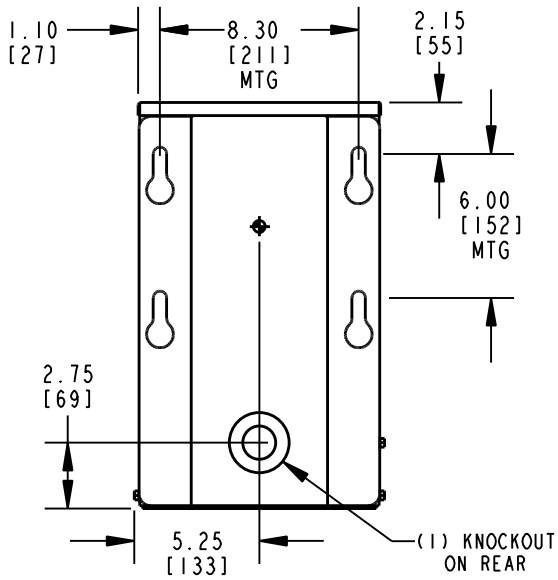

SIDE VIEW

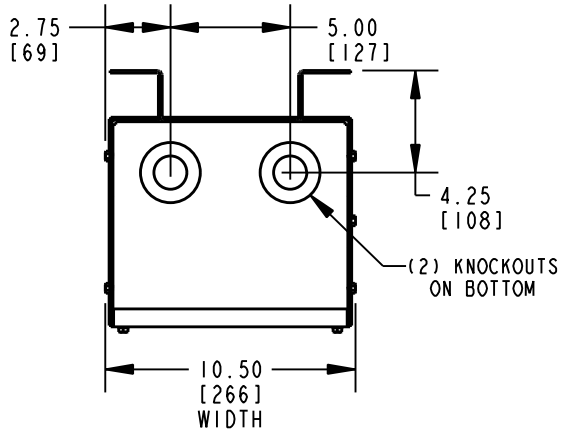
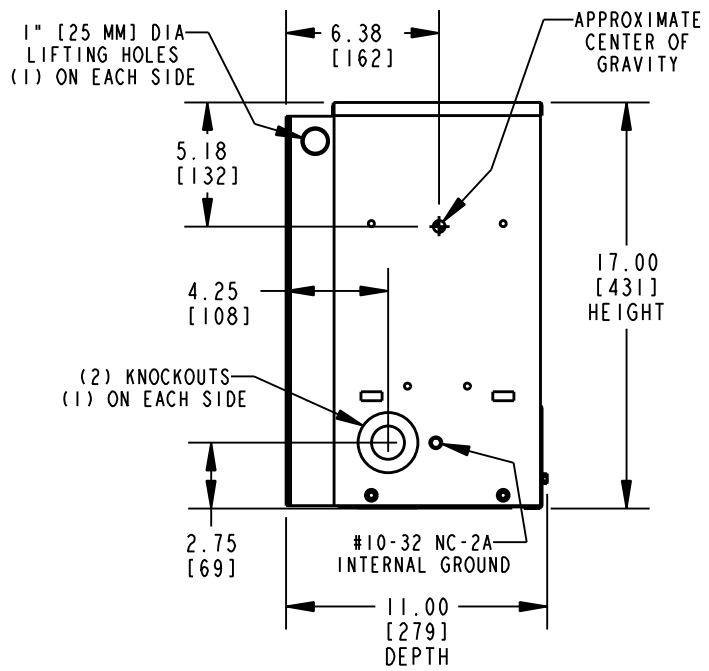

BOTTOM VIEW.

ISOMETRIC VIEW

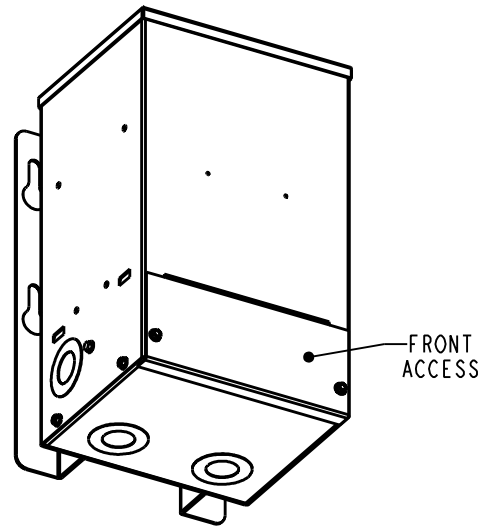

APPROX TOTAL WEIGHT LBS [KG]
PAINTED: 150 [68]

kVA RATING:
K-FACTOR:
PRI VOLTAGE:
SEC VOLTAGE:
FREQ (Hz):
TEMP RISE:
WINDING MATL:
ES SHIELD:
SOUND LVL (dB):

KNOCKOUTS	
CONDUIT SIZE	TOTAL QUANTITY
1" OR 2" [27 OR 53 MM]	5

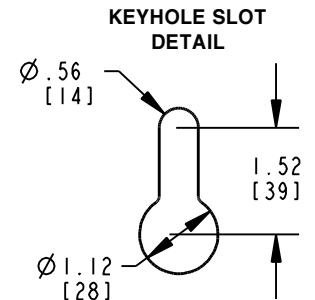

JOB NAME:
SPEEDI PROP:

UNLESS OTHERWISE SPECIFIED
ALL DIMENSIONS ARE INCH [MM]



Transformers

by ABB

THIRD ANGLE PROJECTION

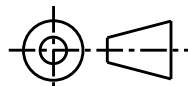

DRY TYPE TRANSFORMER OUTLINE DRAWING
TYPE QMS, 1-PHASE
(ENCLOSED INDOOR/OUTDOOR UNIT)

electrification.us.abb.com

CAD DRAWING: 303B923AAP007

SHEET 1 OF 1

CATALOG #

REV 4