

FRONT VIEW

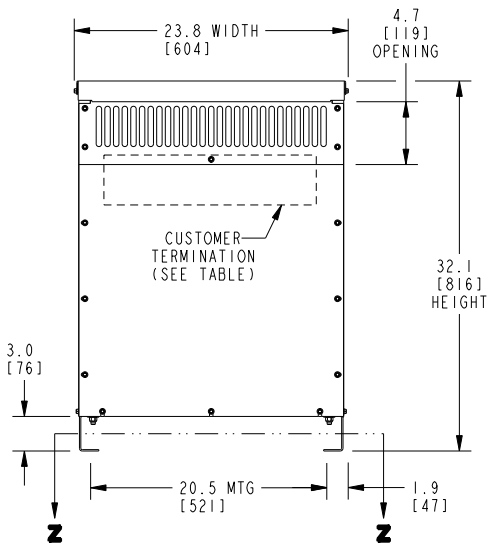

SIDE VIEW

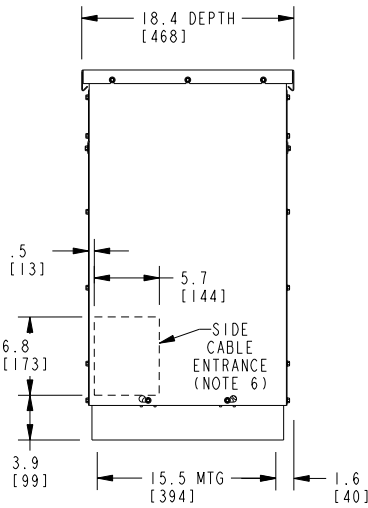

ISOMETRIC VIEW

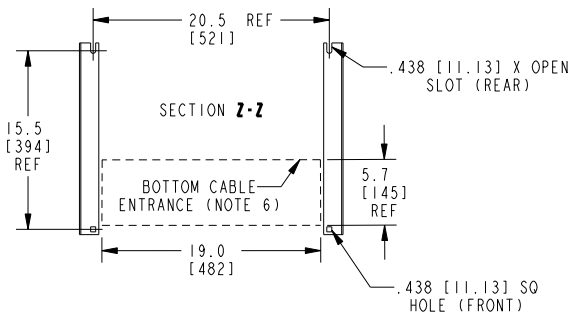
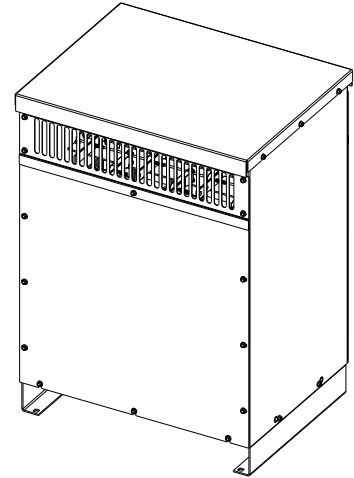

BOTTOM VIEW OF MOUNTING AND CABLE ENTRANCE

CUSTOMER TERMINATION

LOCATION	CONNECTION TYPE	HOLE SIZE	HOLE QTY
PRIMARY BUS BARS	STANDARD BUS BAR (LUGS ARE OPTIONAL)	.41 [10.3] DIA	1 PER BUS BAR
SECONDARY BUS BARS			

APPROX TOTAL WEIGHT LBS [KG]

AL WINDINGS: 415 [188]

CU WINDINGS: 490 [222]

kVA RATING:

K-FACTOR:

PRI VOLTAGE:

SEC VOLTAGE:

FREQ (Hz):

TEMP RISE:

WINDING MATL:

ES SHIELD:

SOUND LVL (dB):

NOTES:

- 1) ALL UNITS ARE UL LISTED AND ARE DESIGNED PER NEMA ST-20 STANDARDS.
- 2) THE TEMPERATURE RISE LISTED IS DETERMINED WHEN THE TRANSFORMER IS MOUNTED IN A STANDARD NEMA 2 ENCLOSURE.
- 3) TRANSFORMER IS DESIGNED FOR FLOOR MOUNTING. OPTIONAL WALL MOUNTING BRACKETS ARE AVAILABLE.
- 4) TRANSFORMER IS DRY TYPE, CLASS AA, WITH VENTILATED ENCLOSURE FOR INDOOR USE. OPTIONAL RAINSHIELD KITS ARE AVAILABLE TO ADAPT UNIT FOR TYPE 3R OUTDOOR USE WITHOUT VOIDING THE WARRANTY.
- 5) APPLICABLE WHEN OPTIONAL RAINSHIELDS ARE INSTALLED. RAINSHIELDS ARE SHIPPED IN KITS FOR FIELD INSTALLATION.
- 6) CABLE ENTRANCE IS PERMITTED THROUGH THE LEFT SIDE, RIGHT SIDE AND/OR BOTTOM ENCLOSURE PANELS ONLY. CABLE ENTRANCE IS NOT PERMITTED THROUGH THE FRONT, REAR OR TOP PANELS.
- 7) FOR LIFTING OTHER THAN WITH A FORK TRUCK, REMOVE TOP COVER AND USE 1" [25 MM] DIAMETER HOLES IN THE TOP CORE CLAMPS.
- 8) ENCLOSURE PAINT COLOR IS ANSI #61 GRAY.
- 9) 6" [152 MM] MINIMUM CLEARANCE IS REQUIRED FROM ALL WALLS.

JOB NAME:

SPEEDI PROP:

UNLESS OTHERWISE SPECIFIED
ALL DIMENSIONS ARE INCH [MM]



GE Energy

THIRD ANGLE PROJECTION

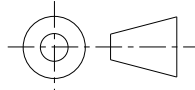

**DRY TYPE TRANSFORMER OUTLINE DRAWING
TYPE QL, K=4, 3-PHASE
(ENCLOSED UNIT)**

CAD DRAWING: 303B990AAP073

SHEET 1 OF 1

CATALOG #

REV 3