

GE PROPRIETARY AND CONFIDENTIAL INFORMATION
 This document is the property of General Electric Company ("GE") and contains proprietary information of GE. This document is loaned on the express condition that neither it nor the information contained therein shall be disclosed to others without the express written consent of GE Industrial Systems, and that the information shall be used by the recipient only as approved expressly by GE Industrial Systems. This document shall be returned to GE upon its request. This document may be subject to certain restrictions under U.S. export control laws and regulations.

SIZE	DRAWING NO.	REV	SHEET
	50C-3015	A	11
REVISIONS			
REV.	DESCRIPTION	DATE	APPROVED
A	S-8687	08/16/07	GG YP
DRAWING ESTABLISHED			

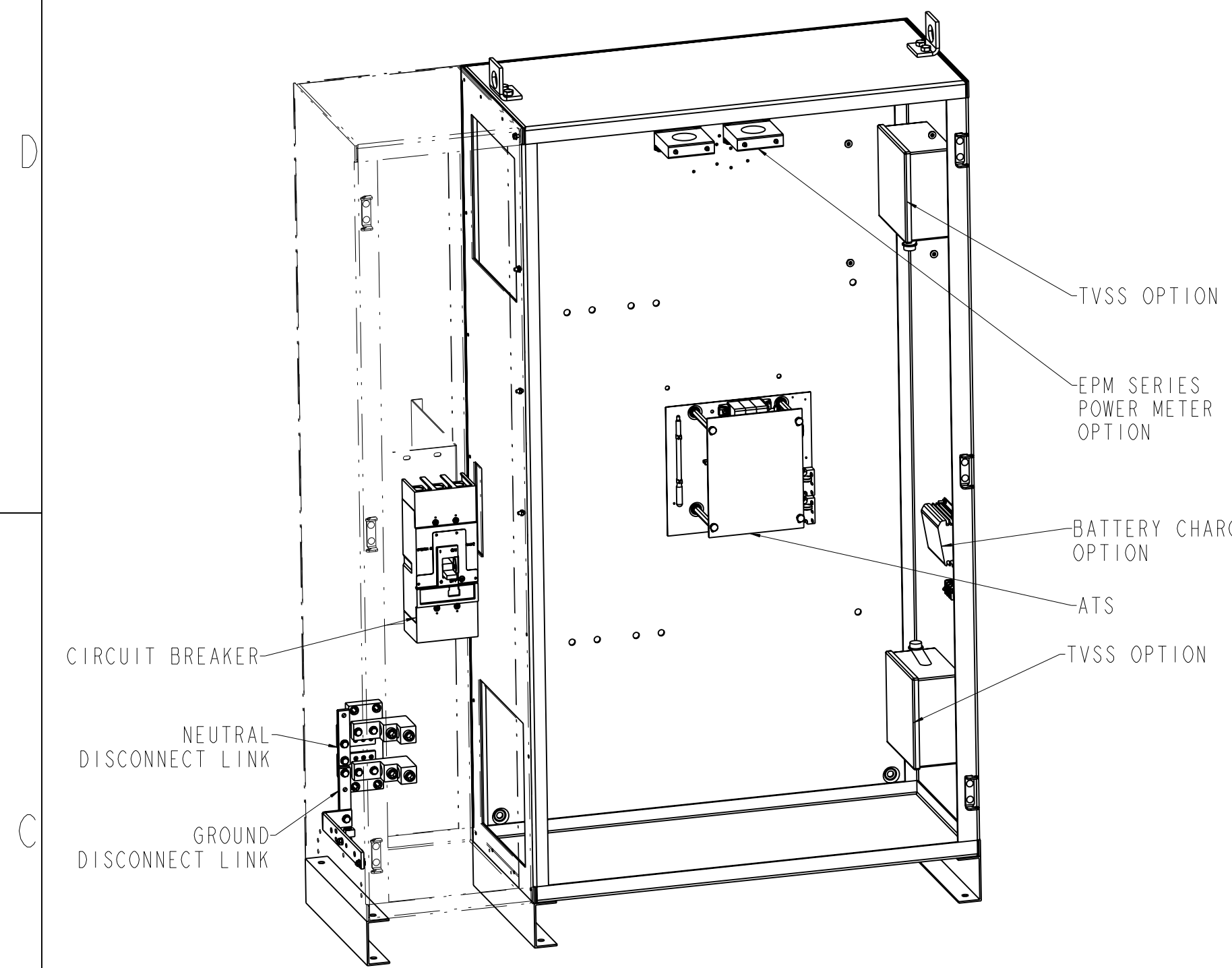

ISOMETRIC VIEW
 WITHOUT ENCLOSURE DOOR
 SCALE 0.090

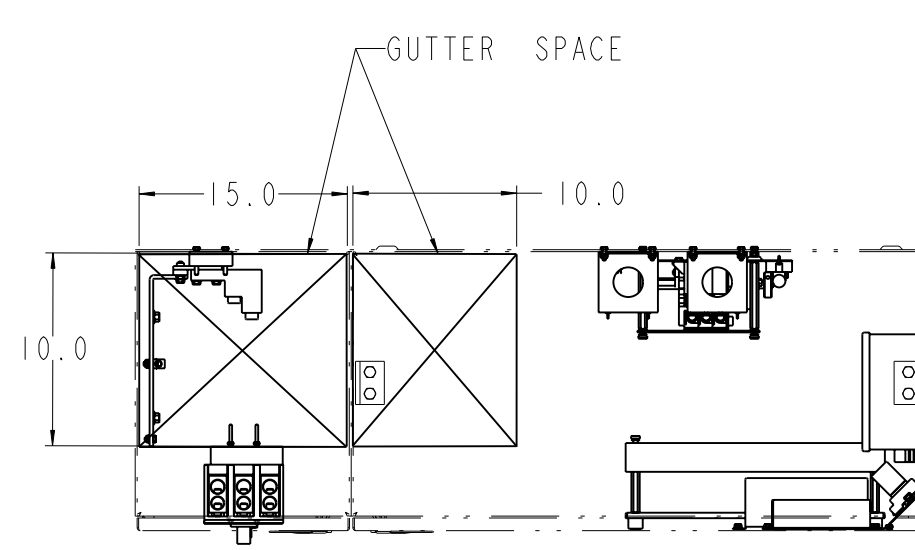

TOP VIEW
 ENCLOSURE IN PHANTOM
 DISPLAY

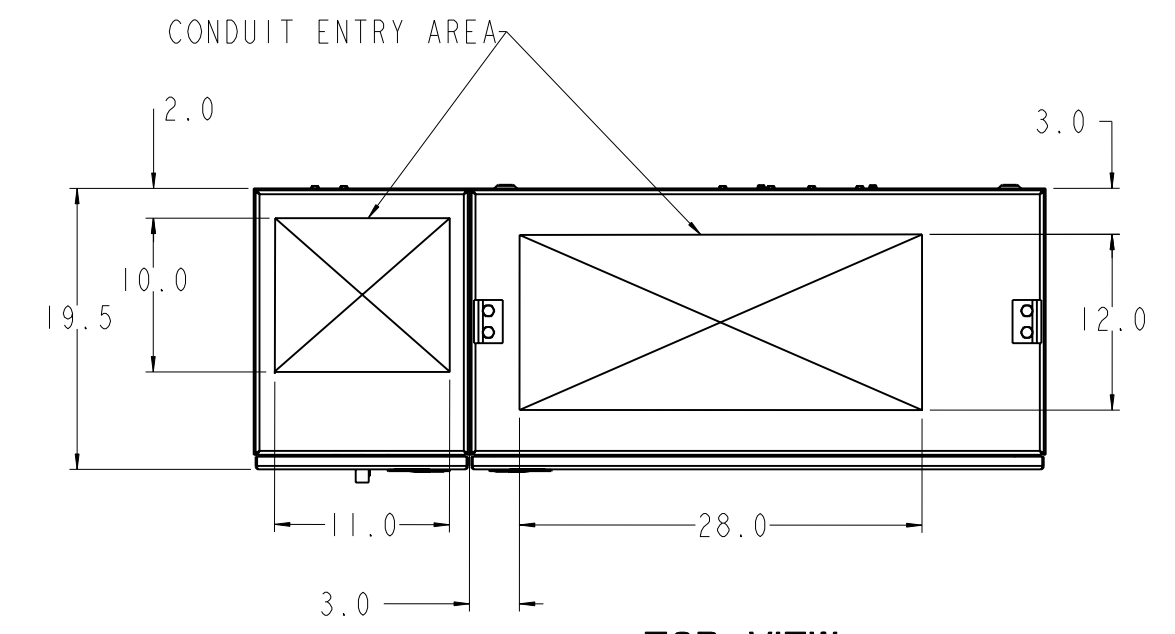

TOP VIEW

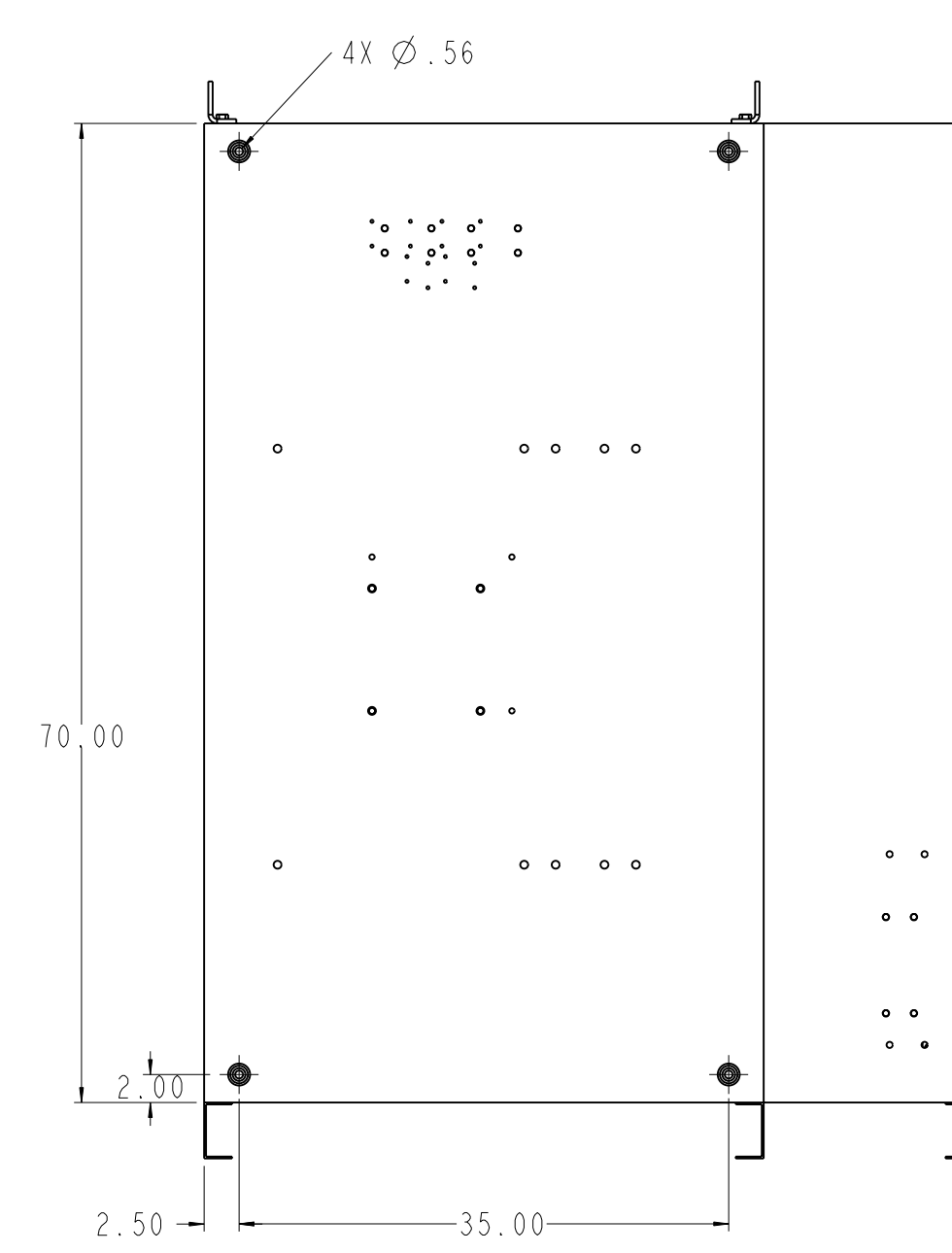

REAR VIEW
 MOUNTING DETAIL

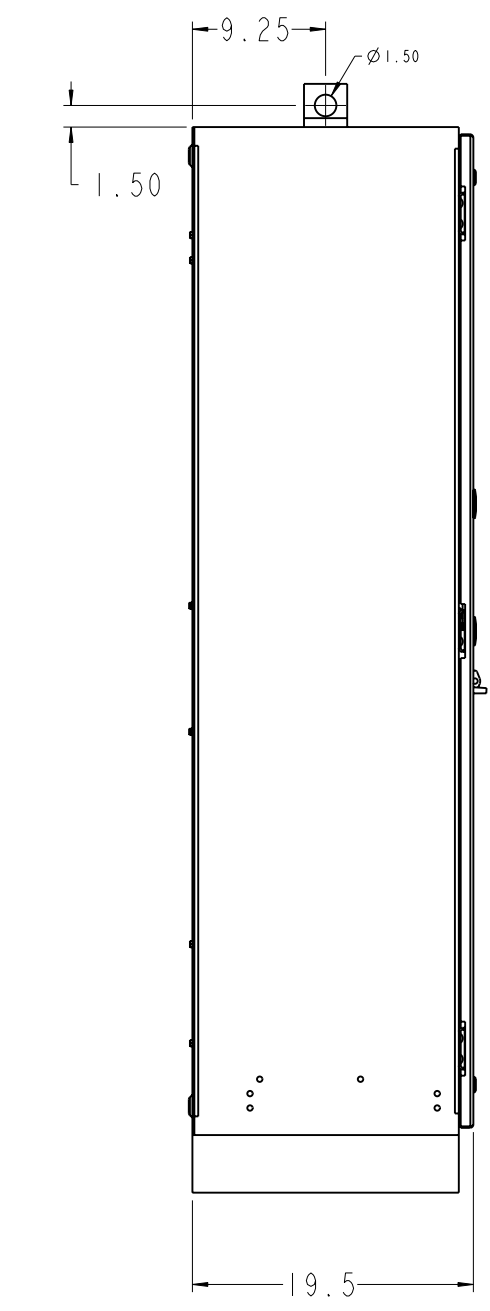

LH SIDE VIEW

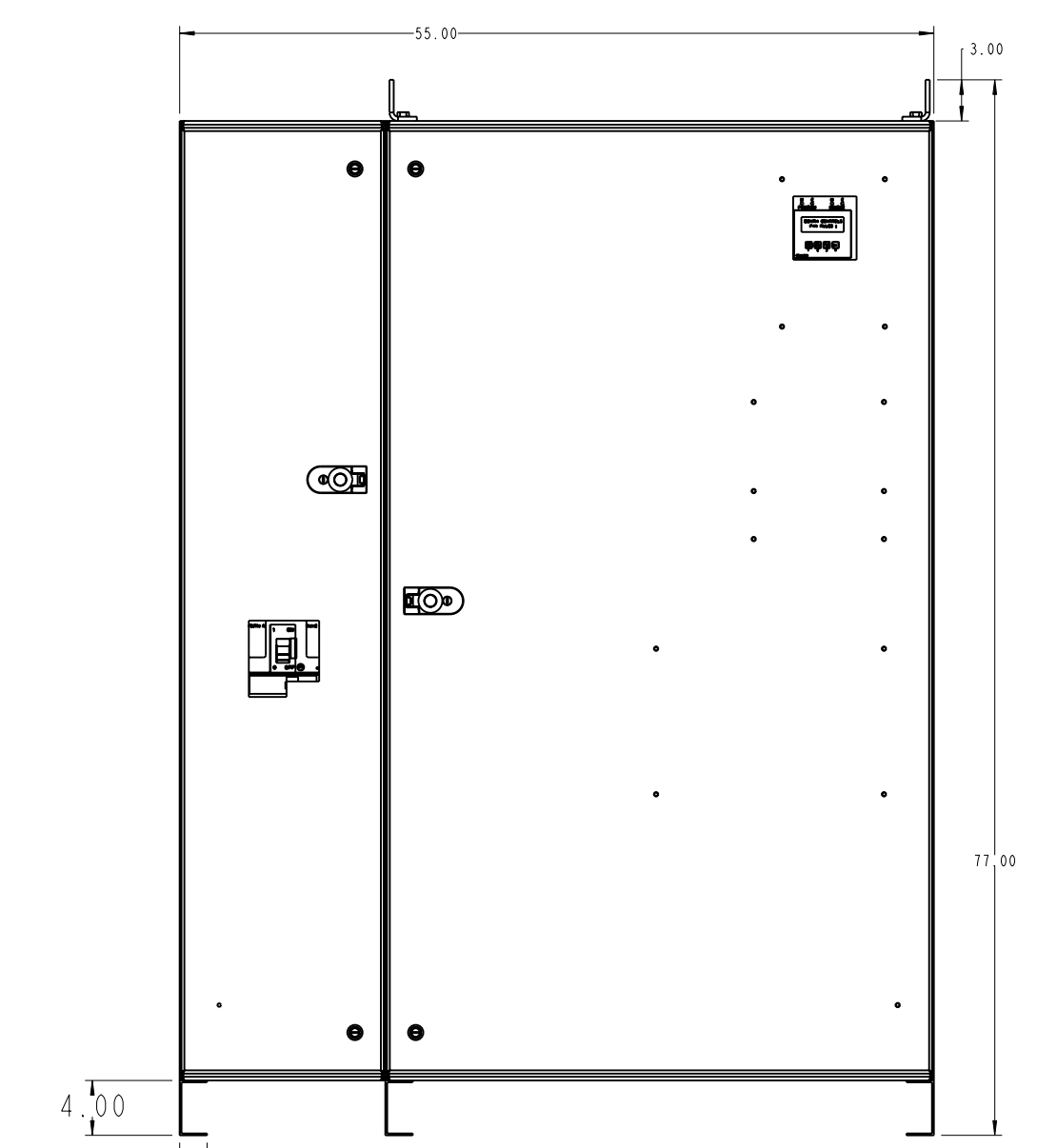

FRONT VIEW
 SCALE 0.075

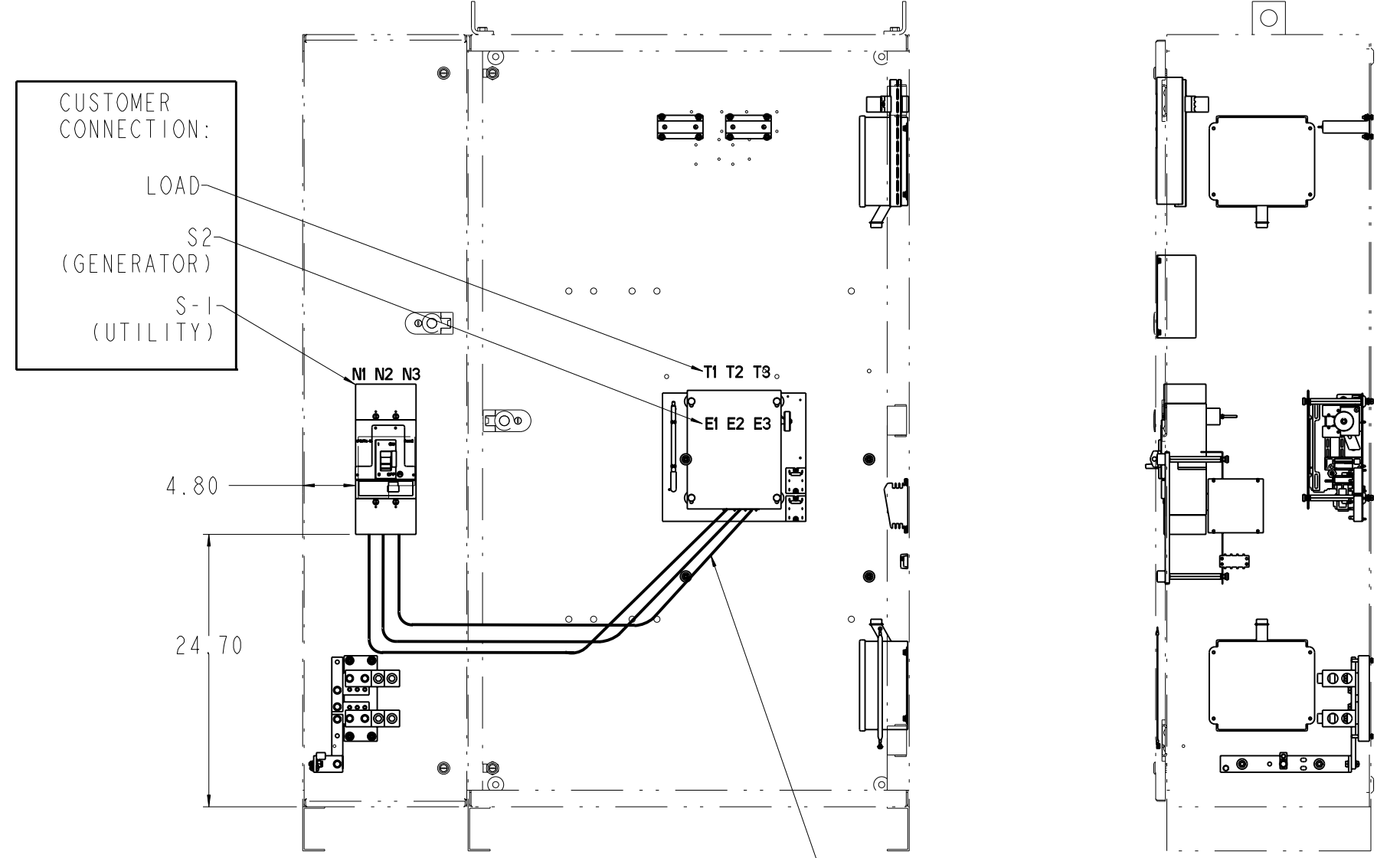

FRONT VIEW
 WITHOUT FRONT DOOR
 SCALE 0.075

RH SIDE VIEW

OPTIONS			
NAME	DESCRIPTION	OPTIONS	NOTES
BC	BATTERY CHARGER	12V/6AMP OR 24V/3AMP OUTPUT	
TVSS	GE TRANQUELL ME	100KA PER MODE, MEDIUM EXPOSURE AVAILABLE FOR SOURCE 1, 2 AND LOAD	
EPM	POWER METER	SERIES OF METERING OPTIONS	
STS	SHUNT TRIP SELECTOR	DOOR MOUNTED SHUNT TRIP SELECTOR SWITCH WITH SIGNAL INDICATING THE TRIP POSITION	
BB	C/B AUX CONTACTS	1 CONTACT WITH STS AND 2 WITHOUT STS OPTION	

CONTACT GE ZENITH CONTROLS FOR ADDITIONAL OPTIONS
 OPTIONAL ACCESSORIES SHOWN IN PHANTOM DISPLAY

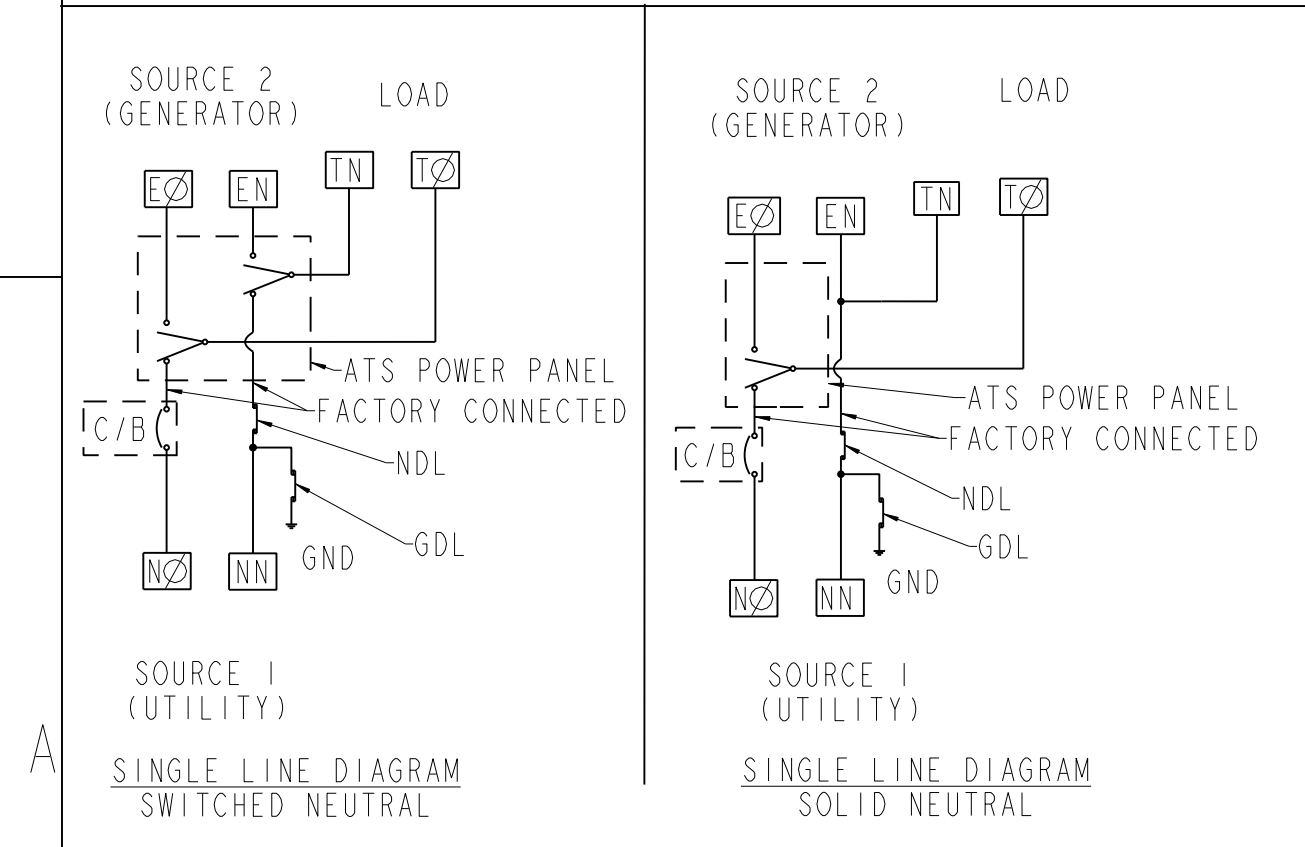

LEGEND:
 ATC - AUTOMATIC TRANSFER SWITCH
 C/B - MOLDED CASE CIRCUIT BREAKER
 NDL - NEUTRAL DISCONNECT LINK
 GDL - GROUND DISCONNECT LINK

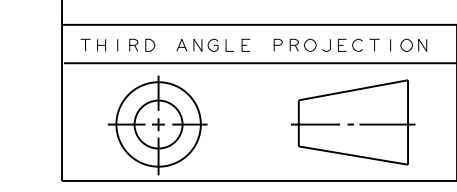

AMP	MCCB FRAME	80% RATED	WIRE RANGE			ATS WCR RATING (UL) @ 480V	BREAKER IC RATING (UL) @ 480V
			S-1 (UTILITY)	S-2 (GENERATOR)	LOAD		
40	SE	60AF / 40AT	(1) 12 AWG-3/0	(1) 8 AWG-3/0	(1) 8 AWG-3/0	30KA	65KA
80	SE	100AF / 80AT	(1) 12 AWG-3/0	(1) 8 AWG-3/0	(1) 8 AWG-3/0	30KA	65KA
100	SF	250AF / 100AT	(1) 8 AWG-350MCM	(1) 8 AWG-3/0	(1) 8 AWG-3/0	30KA	65KA
150	SF	250AF / 150AT	(1) 8 AWG-350MCM	(1) 8 AWG-3/0	(1) 8 AWG-3/0	30KA	65KA
200	SF	250AF / 200AT	(1) 8 AWG-350MCM	(1) 6 AWG-250MCM	(1) 6 AWG-250MCM	30KA	65KA
225	SG	400AF / 225AT	(1) 8 AWG-500MCM OR (1) 2/0-600MCM	(1) 6 AWG-250MCM	(1) 6 AWG-250MCM	30KA	65KA
260	SG	400AF / 250AT	(1) 8 AWG-500MCM OR (1) 2/0-600MCM	(1) 6 AWG-350MCM	(1) 6 AWG-350MCM	35KA	65KA
400	SG	600AF / 400AT	(1) 8 AWG-500MCM OR (1) 2/0-600MCM	(1) 4 AWG-600MCM OR (2) 1/0-250MCM	(1) 4 AWG-600MCM OR (2) 1/0-250MCM	50KA	65KA
600	SK	800AF / 600AT	(3) 3/0 500MCM	(2) 2 AWG-600MCM	(2) 2 AWG-600MCM	50KA	65KA
800	SK	1200AF / 800AT	(4) 250-500 MCM	(4) 2 AWG-600MCM	(4) 2 AWG-600MCM	65KA	65KA

Part must conform to SI 900000 Sect. 4, Toxicity Procedure

NOTES:
 ENCLOSURE: NEMA 1 TYPE
 FLOOR AND OR WALL MOUNTED
 FINISH: ANSI 61 GRAY
 ACCESS: FRONT ONLY
 MCCB ACCESSORY: PADLOCKING (PROVISION ONLY)
 GUTTER SPACE: SEE THE TOP VIEW, ENCLOSURE IN PHANTOM DISPLAY VIEW
 CONDUIT ENTRY: SEE THE TOP AND THE BOTTOM VIEWS
 SYSTEM RATING AND SPECIFICATIONS:
 SERVICE ENTRANCE: 40-800A, 3POLE UNIT, FULLY RATED
 NEUTRAL DISCONNECT LINK: 100% RATED
 GROUND DISCONNECT LINK: 100% RATED

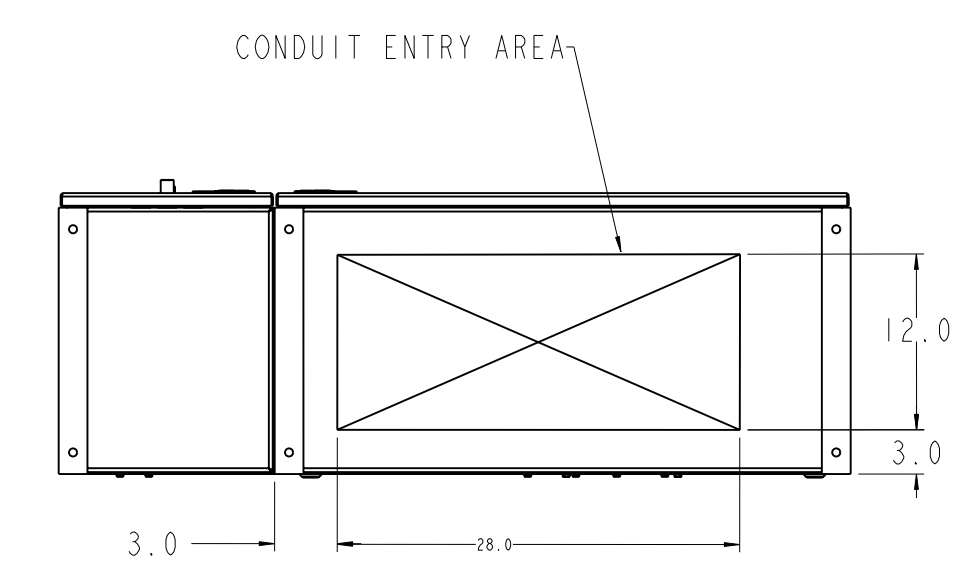

BOTTOM VIEW

FOR ADDITIONAL INFO REFER TO:	SIGNATURES	DATE
APPLIED PRACTICES	MODEL	YP 08/06/07
DIMENSIONS ARE IN INCHES	DETAIL	
UNLESS OTHERWISE SPECIFIED IN DRAWING	CHECKED	YP 08/06/07
TOLERANCE ON:	ENGRG	YP 08/06/07
1 PL DECIMALS ± 0.0	MFG	
2 PL DECIMALS ± 0.02	QUALITY	
3 PL DECIMALS ± 0.005	ISSUED	
ANGLES ± 1.0		
FRACTIONS ± FINISH		
CRITICAL TO QUALITY CHARACTERISTIC		

GE Zenith Controls

TITLE
OUTLINE DRAWING
40-800 AMP, 3-POLE, NEMA-1
SERVICE ENTRANCE

SIZE D DRAWING
 50C-3015 A
 SCALE: 0.040 REF. No.: SHEET 1 OF 1