

REVISIONS			
REV.	DESCRIPTION	DATE	APPROVED
1	C079254 UPDATED REBRANDING	10/18/19	GK MAS

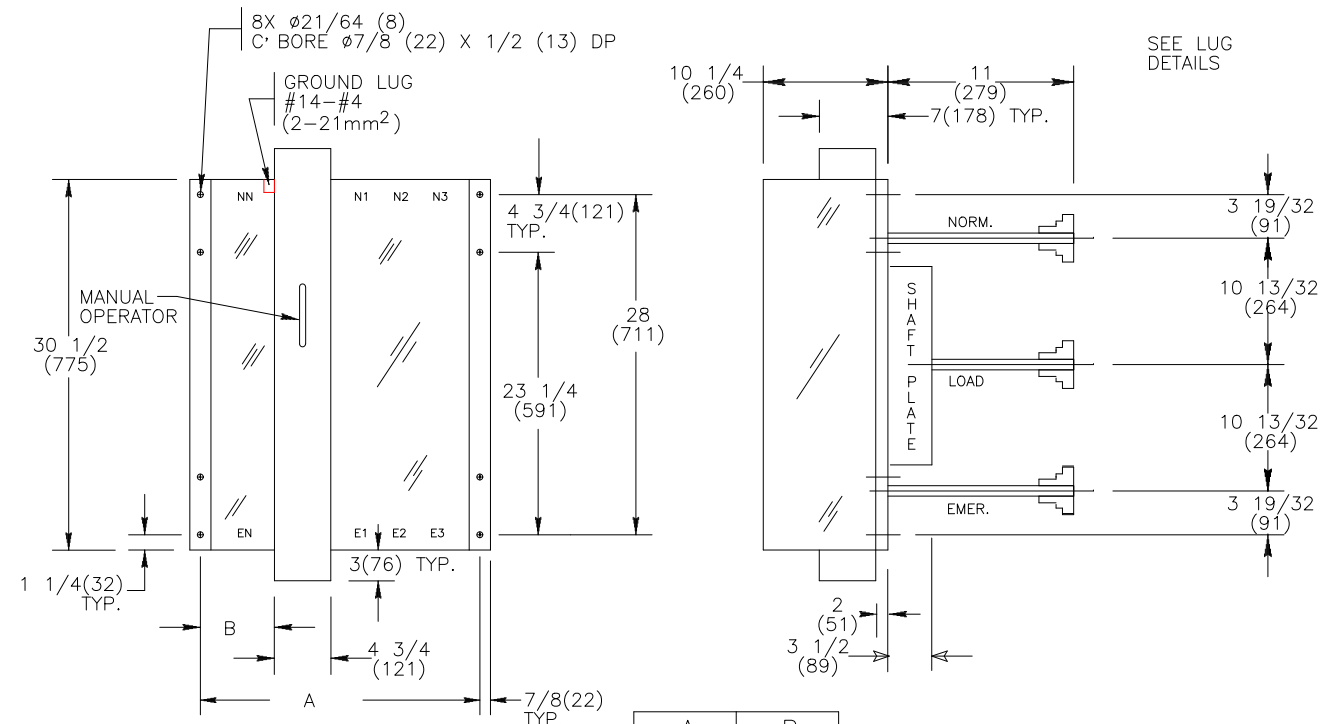

	A	B
2/3-POLE	23 (584)	7/8 (22)
4-POLE	28 1/2 (724)	6 3/8 (162)

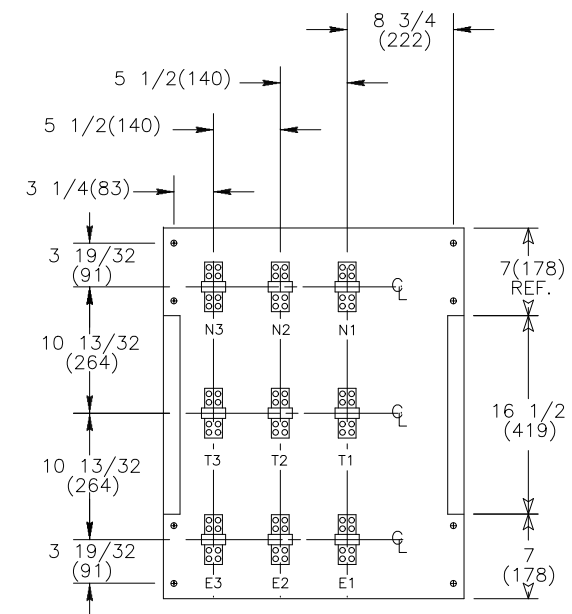
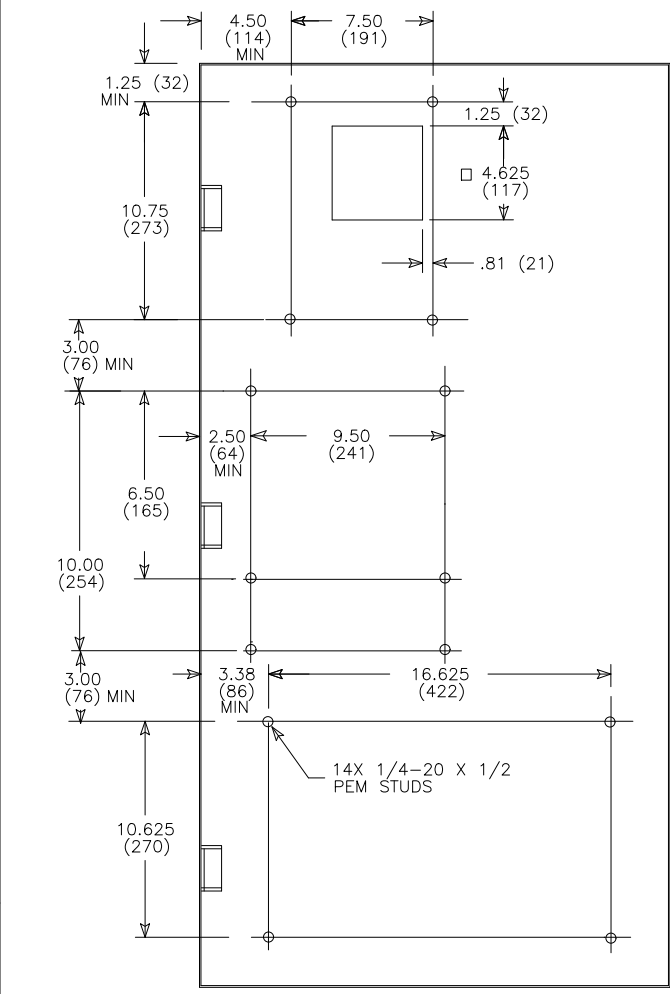
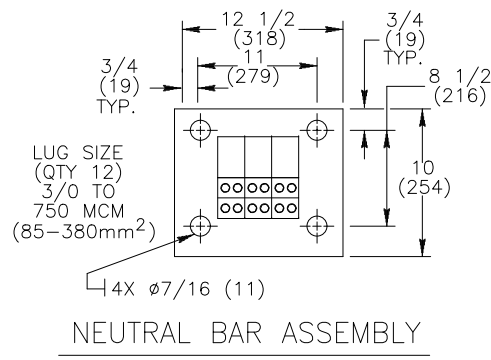

2/3-POLE SWITCH LUG DETAILS (REAR VIEW)

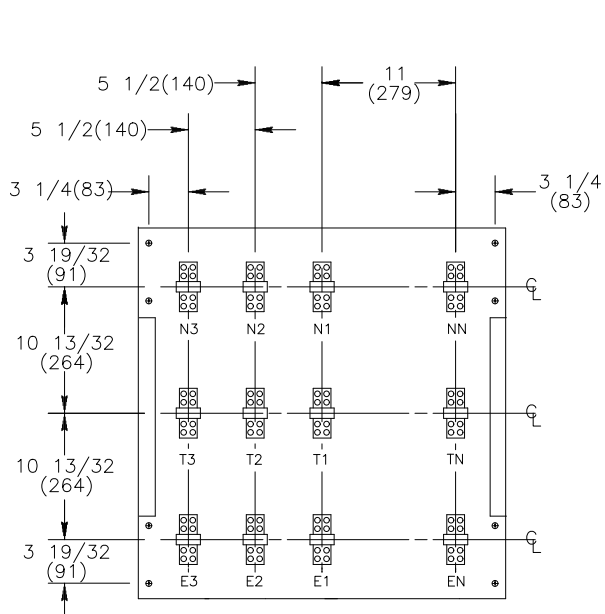

4-POLE SWITCH LUG DETAILS (REAR VIEW)

- NOTES:
- FOR 2-POLE SWITCHES, OMIT CENTER POLE.
 - OPEN TYPE SWITCH SUPPLIED WITH 6 FT. (1.8m) LONG HARNESS BETWEEN POWER AND CONTROL PANELS. HARNESS EXITS FROM LOWER RIGHT CORNER OF POWER PANEL.
 - DO NOT RUN CABLES IN FRONT OF SWITCH. RUN ALL CABLES ON RIGHT SIDE.
 - ALL FRACTIONAL TOLERANCES ±1/64(0.4mm) UNLESS OTHERWISE SPECIFIED.
 - MAINTAIN ELECTRICAL CLEARANCE OF 1(25mm) MIN. BETWEEN LIVE METAL PARTS AND GROUNDED METAL.
 - ALL DIMENSIONS ARE FOR REFERENCE ONLY AND SHOWN IN INCHES(MILLIMETERS).

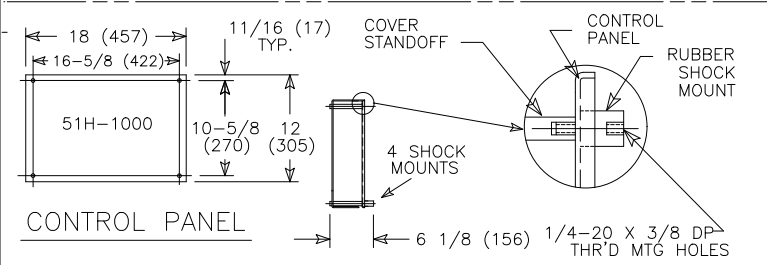

CONTROL PANEL

THIRD ANGLE PROJECTION

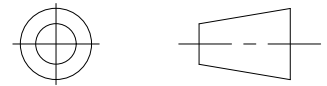

ABB PROPRIETARY AND CONFIDENTIAL INFORMATION
 The information contained in the document has to be kept strictly confidential. Any unauthorized use, reproduction, distribution or disclosure to third parties is strictly forbidden.
 ABB reserves all rights regarding intellectual Property Rights.
 Copyright 2018 ABB. All rights reserved

SIGNATURES		DATE
MODEL	EC	5/11/98
DETAIL		
CHECKED		
ENGRG	SB	5/11/98
MFG		
QUALITY		
ISSUED		
DRAWING FILE:	52C-2010	
MODEL / ASSEMBLY FILE:	ZTGK20-300 (2000-3000 AMP) 2,3,4 POLES	
# CTGs	⊕ CRITICAL TO QUALITY CHARACTERISTIC	

ABB		
TITLE		
TRANSFER SWITCH REAR LUGS		
FIRST MADE FOR:	ZTGK (1600-2000 AMP) 2,3,4 POLES	
SIZE	B	CAGE CODE
DWG NO	52C-2010	
SCALE:	N/A	SHEET 1 OF 1

AutoCad Generated