

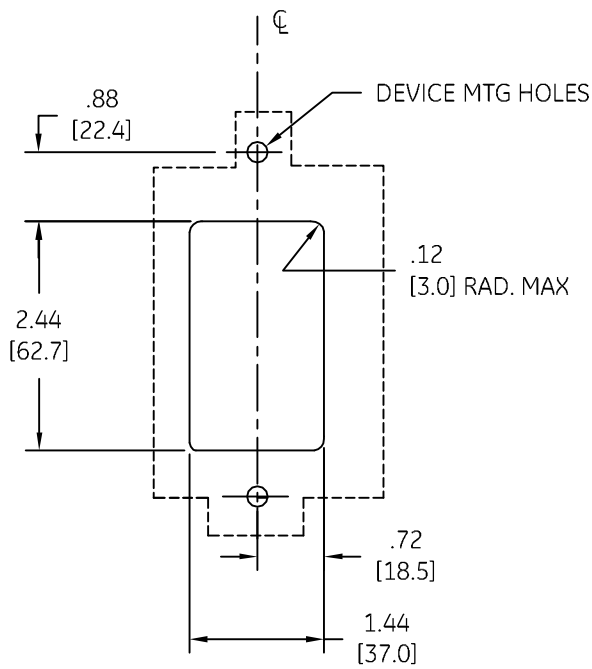

DUAL DIMENSIONS INCHES (ESTIMATING ONLY)  
[MILLIMETERS]

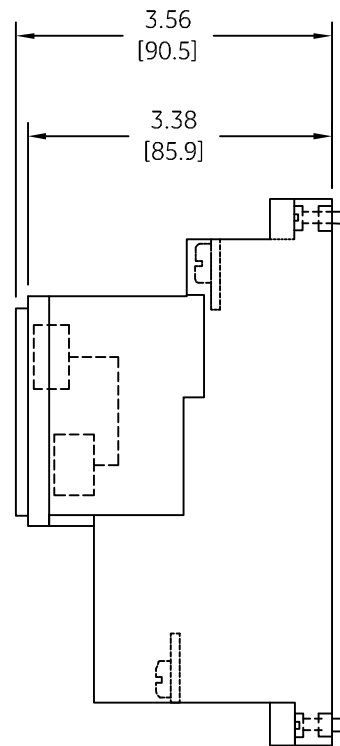
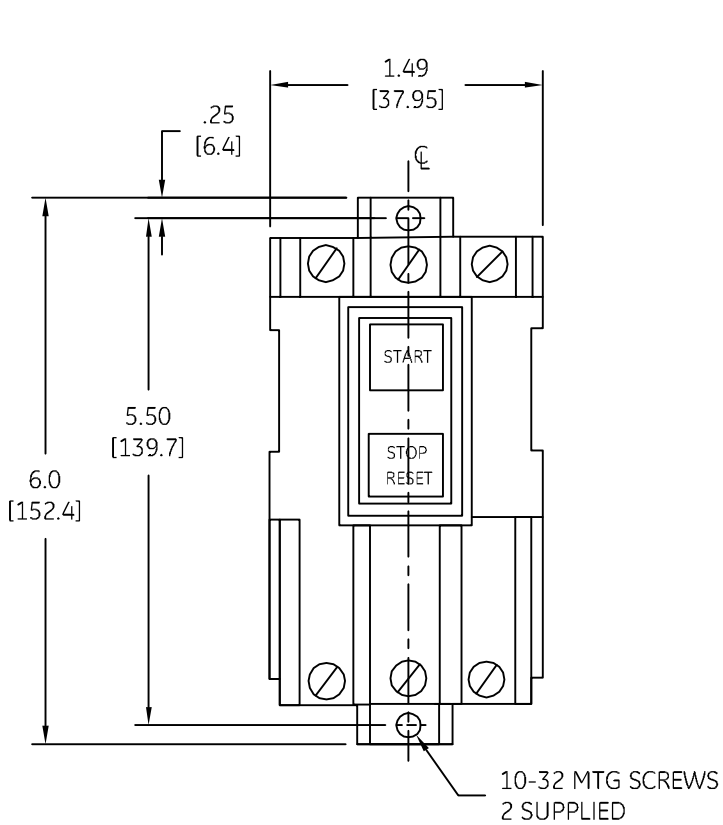

 imagination at work

OUTLINE  
CR1062 SIZE R&S OPEN

DWG NO.	DATE	REV
55-156707	12/19/2009	3

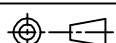
AN #	THIRD ANGLE PROJECTION	SHEET #
09-9121		1 OF 1