

DUAL DIMENSIONS INCHES (ESTIMATING ONLY)
[MILLIMETERS]

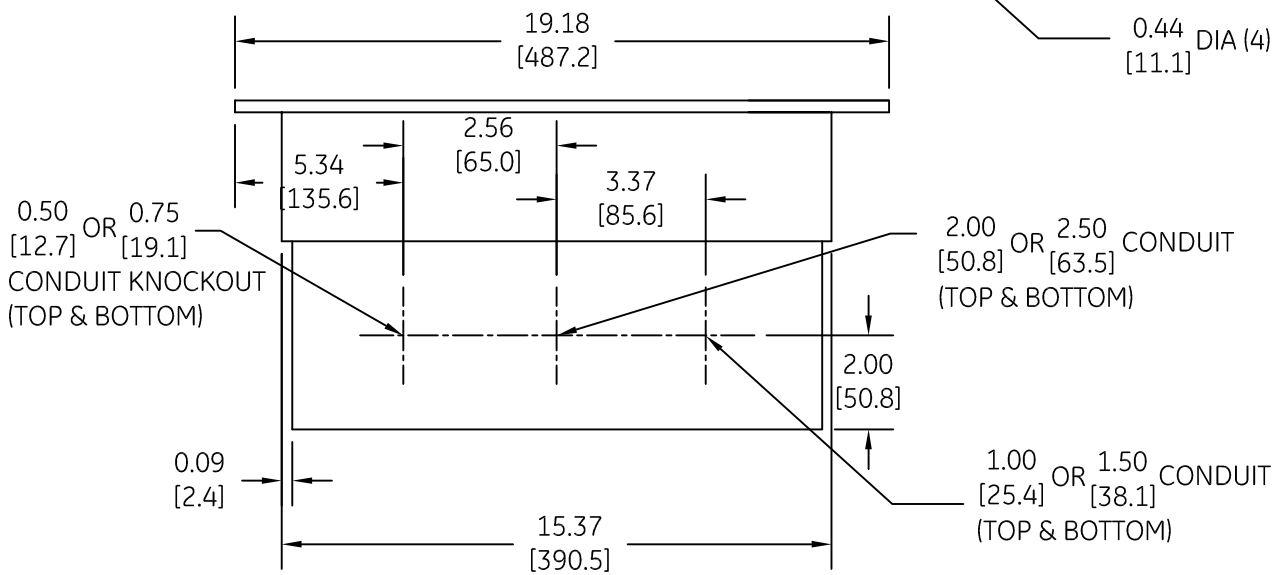
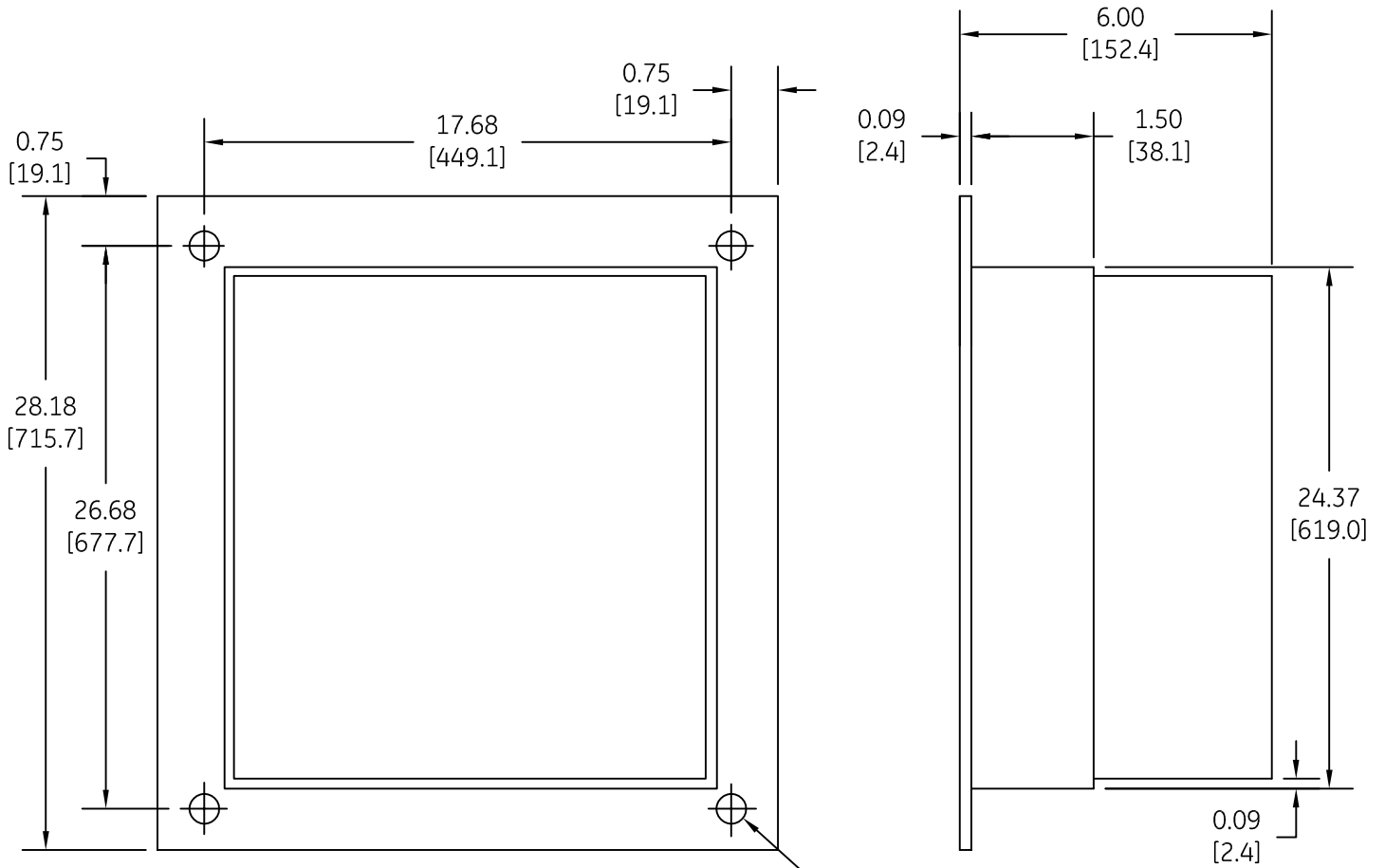

OUTLINE-CR160MC
LIGHTING CONTACTOR TYPE 1 FLUSH MOUNT ENCLOSED

AN #	THIRD ANGLE PROJECTION	SHEET #
09-9114		1 OF 1

DWG NO.	DATE	REV
55-176887	08/26/2009	2