

DUAL DIMENSIONS INCHES (ESTIMATING ONLY)
[MILLIMETERS]

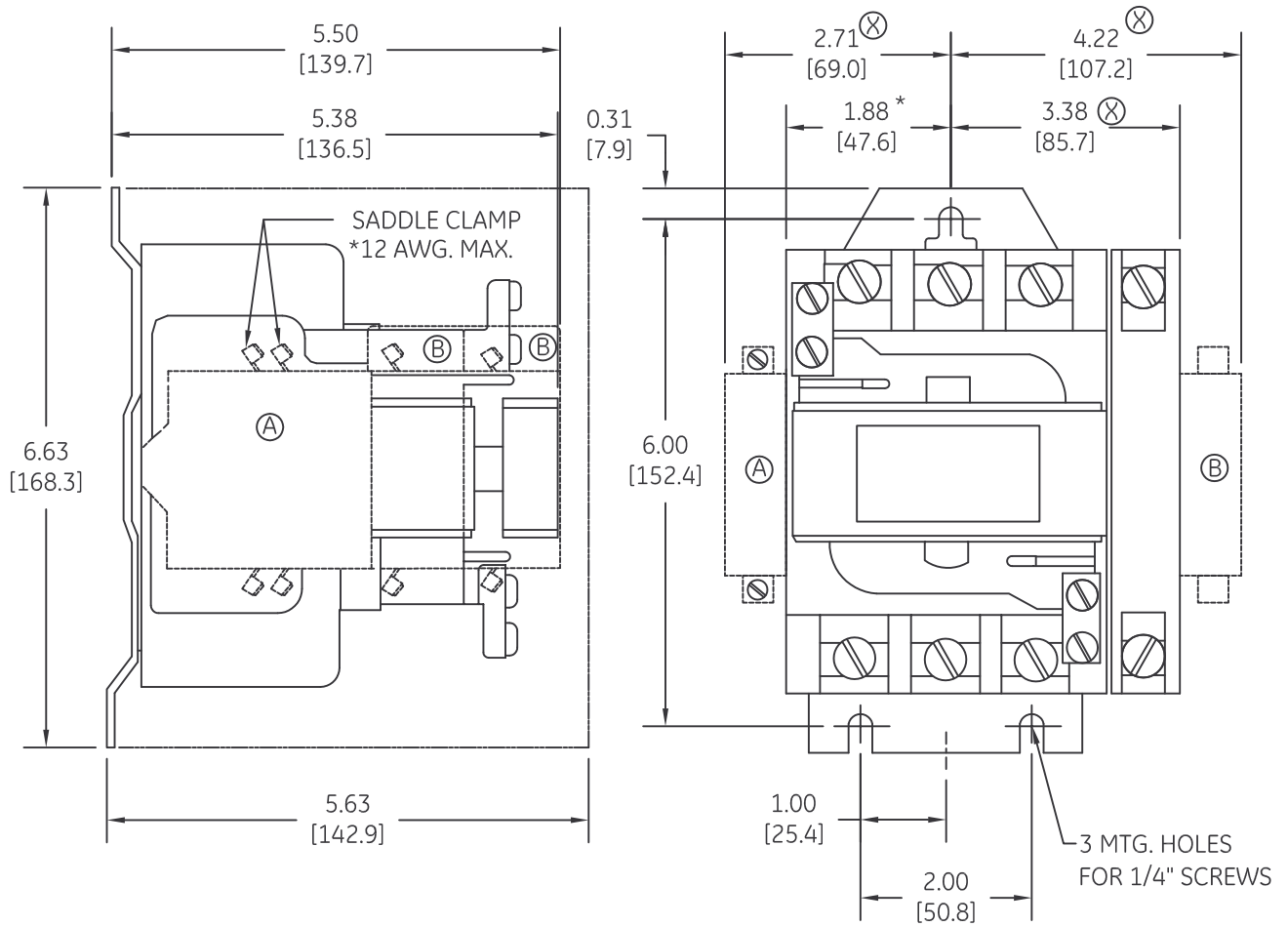

(A) — HOLDING INTERLOCK AND/OR EXTRA AUX. CONTACTS (IF USED)

(B) — EXTRA AUX. CONTACT (IF USED)

* — ADD 1/2 INCH FOR ELECTRICAL CLEARANCE

(X) — ADD 3/8 INCH FOR ELECTRICAL CLEARANCE

--- ELECTRICAL CLEARANCE REQUIREMENT



imagination at work

OUTLINE
CR360L LIGHTING CONTACTOR OPEN

AN #	THIRD ANGLE PROJECTION	SHEET #
09-9114		1 OF 1

DWG NO.	DATE	REV
55-193052	08/27/2009	1