

DUAL DIMENSIONS      INCHES      (ESTIMATING ONLY)  
 [MILLIMETERS]

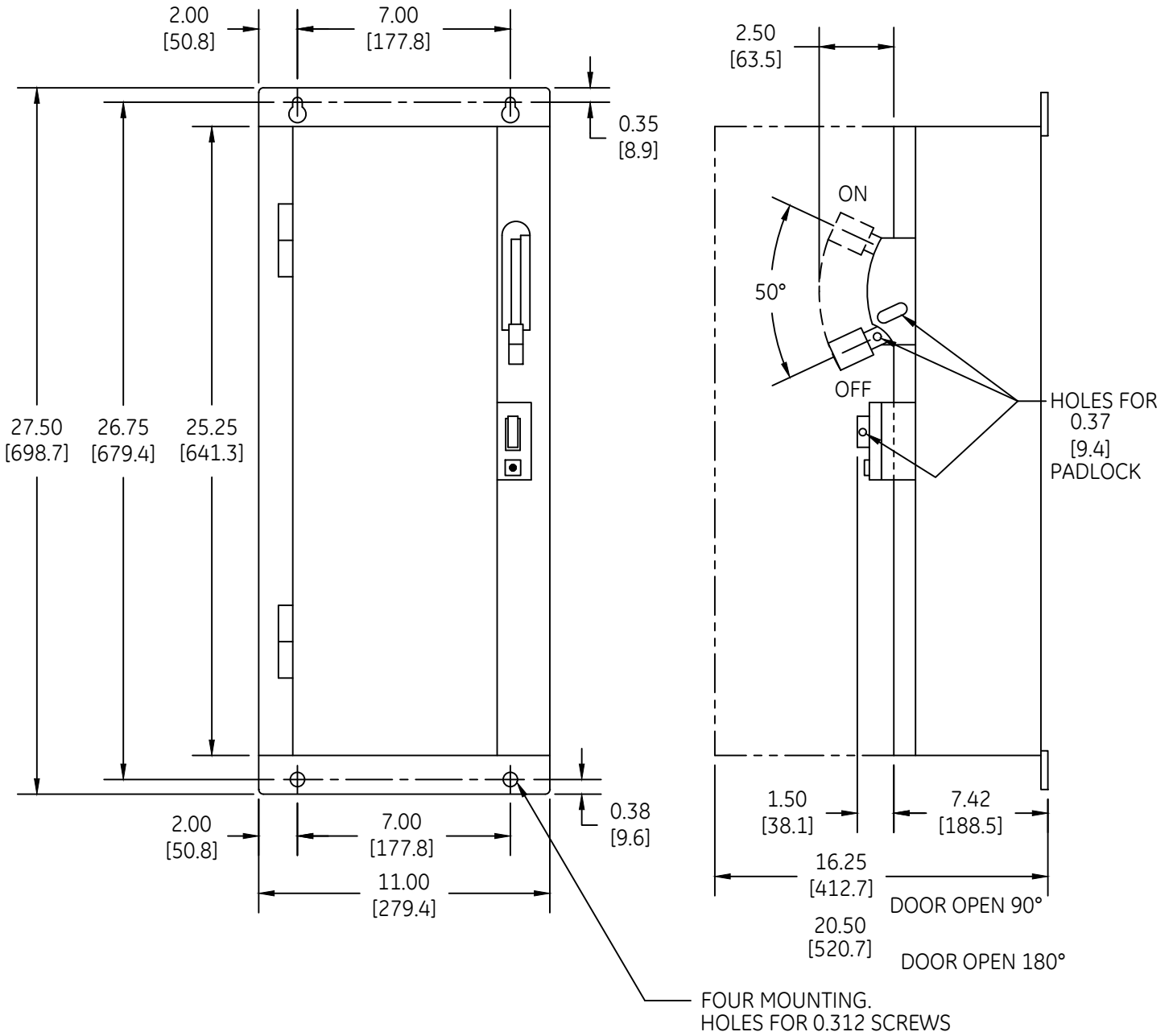

OUTLINE  
 TYPE 12 ENCLOSED

THIRD ANGLE	SHEET#	DWG NO.	DATE	REV
	1 of 1	55-206995	03/21	04