

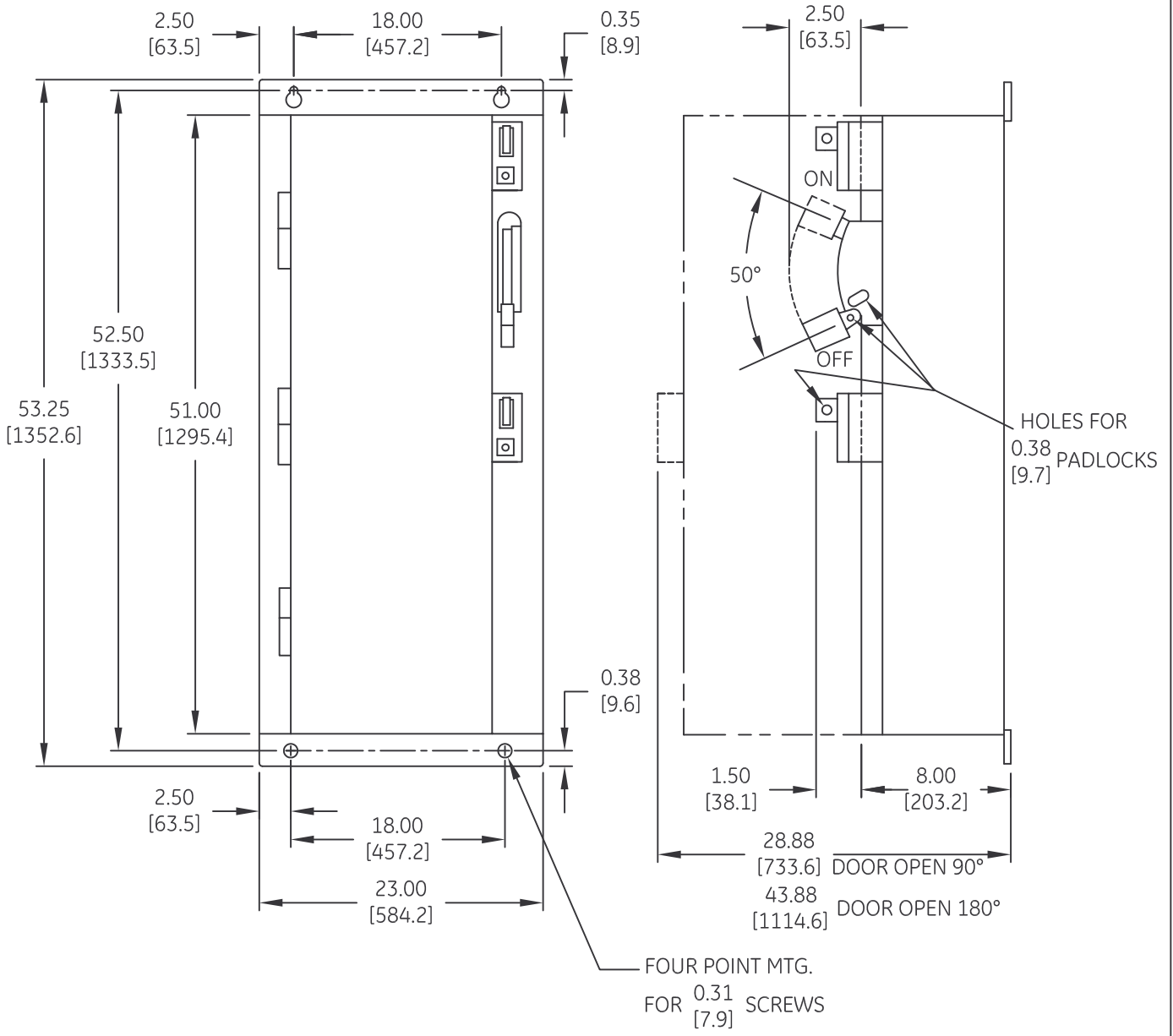

DUAL DIMENSIONS INCHES (ESTIMATING ONLY)
[MILLIMETERS]



 imagination at work

OUTLINE
TYPE 12 ENCLOSED

DWG NO.	DATE	REV
55-213180	08/24/2009	2

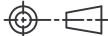
AN #	THIRD ANGLE PROJECTION	SHEET #
09-9112		1 OF 1