

OPERATION AND MAINTENANCE MANUAL

Zenith MX150

Microprocessor Controller for ZTG(D) series
Automatic Transfer Switches



Authorized Service

For ABB parts and service, call: (773) 299-6600

Table of Contents

	Page		Page
Introduction	2	Testing	19
Safety	3	Standard Transition	19
Equipment Inspection and Storage	3	Delayed Transition	19
Final Equipment Inspection	3	Sequence of Operation	20
Installation	4	Standard Transition	20
Engine Start Control Connections	4	Delayed Transition	20
Initial Energization	4-5	Controls Power Supply (CPS)	21
Control Connections	6	Schematics, Standard and Delay	22
MX150 Microprocessor Controller	7	Troubleshooting & Diagnostics	23
Overview	7	Maintenance and Testing	24
LCD & Keypad	8	Inspection and Cleaning	24
User Setting for Voltage & Frequency	9	Servicing	24
Standard Features, MSTDG Option Pkg. . .	9-10	Testing	24
Standard Features, MEXEG Option Pkg. . .	11		
Optional Accessories	12		
How to Set the System Clock	13		
CDT One Event Timer Exerciser	13-14		
CDP Clock Exerciser	15		
User Setup - CFG Menu	16		
User Setup - SET Menu	17		
User Setup - System Info	18		

Introduction

ABB Zenith Transfer Switches are used to provide a continuous source of power for lighting and other critical loads by automatically transferring from source 1 power to source 2 power in the event that source 1 voltage falls below preset limits.

Voltage sensing and system control is performed via a state-of-the-art microcontroller located on the cabinet door. It is designed to give highly accurate control of the transfer switch system.

All ABB Zenith transfer switches are designed for use on emergency or standby systems, and are rated for total system or motor loads. Transfer switches are UL Listed under Standard 1008 and CSA Certified under Standard C22.2 No. 178 and IEC Listed under Standard 947.

NOTES: A protective device such as a molded case circuit breaker or fused disconnect switch MUST be installed on both sources of incoming power for circuit protection and as a disconnection device.
All references made within this manual about the term "S1" or "Source 1" relate to a Normal Power Source. All references made about the term "S2" or "Source 2" relate to an Emergency or Alternative Power Source.

Safety / Installation

⚠ DANGER ⚠

HAZARDOUS VOLTAGE (Can Cause Severe Injury or Death)

Turn OFF all power before installation, adjustment, or removal of transfer switch or any of its components.

The safe operation of your switch is ABB Zenith's focus. The proper storage, installation, operation and maintenance will help increase the life of the switch.

⚠ CAUTION ⚠

Due to hazardous voltage and current, ABB Zenith recommends that an ABB Zenith Certified technician or a qualified electrician must perform the installation and maintenance of the switch.

Equipment Inspection and Storage

Once you have received the transfer switch, inspect it for any damage. This includes damage to the enclosure, power panel, control panel and wiring harness. If any damage is found or suspected, file a claim as soon as possible with the carrier and notify the nearest ABB Zenith representative.

Before installation, if it is necessary, store the transfer switch in a clean dry place, protected from dirt and water. Provide ample air circulation and heat, if necessary, to prevent condensation.

Storage Temperature	Operating Temperature (Ambient):	Humidity
-30°C to +75°C (-22°F to +167°F)	40-400 AMP (molded shell) 40-4000 AMP (all other frame and panel types)	5% to 95% (non-condensing)
	-20°C to +60°C (-4°F to +149°F)	

Final Equipment Inspection

Prior to energizing the transfer switch:

1. Remove any debris incurred, with a vacuum, due to shipment or installation.
2. Verify that all cabled connections are correct and that phase rotation of both sources match.
3. Check engine start connections.
4. Verify the correct connection of all control wires.
5. Check settings of all timers and adjust as necessary.
6. Adjust any optional accessories as required.
7. Check the lug torque values of the power connections.

NOTE: Lug torque values are specified in the power panel manual.

8. Make sure that all covers and barriers are installed and properly fastened.

NOTE: Power panels ship from ABB Zenith in Source 1 Position.

⚠ WARNING ⚠

Do not use a blower since debris may become lodged in the electrical and mechanical components and cause damage.

Each ABB Zenith transfer switch is factory wired and tested. A complete information package is furnished with each switch which includes:

- a. Sequence of operation.
- b. Description and operation of all accessories supplied.
- c. Power panel connection diagram and schematic.
- d. Description and identification of all customer field connections.

Installation of ABB Zenith transfer switches includes:

- a. Mounting the transfer switch cabinet.
- b. Connection of Source 1, Source 2, and Load cables or bus bars.
- c. Connection of external control circuits as required.

⚠ DANGER ⚠

HAZARDOUS VOLTAGE (Can Cause Severe Injury or Death)

Turn OFF all power before installation, adjustment, or removal of transfer switch or any of its components.

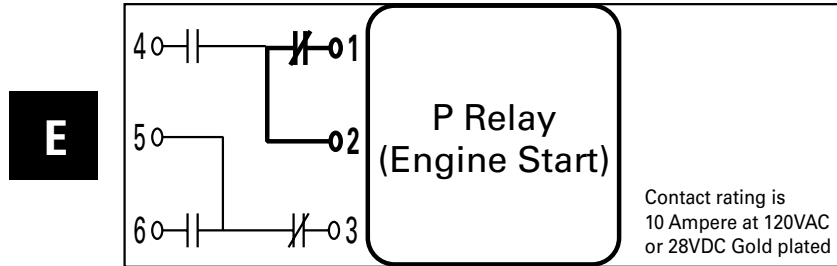



Figure 3

Engine Start Control Connections

The engine-start terminals are clearly identified by a label on the microcontroller backplate. In the case of manual transfer switches, or in other applications not requiring the microprocessor, clearly marked terminal blocks are provided in the upper left corner of the control panel for the engine start control wires.

Terminals for field connections to the A3 Emergency auxiliary contacts and the A4 Normal auxiliary contacts are also provided. These terminals are clearly marked and appear on the side of the power panel. On 400 amp metal frame units these terminals appear on the bracket above the operator handle.

NOTE: The controller will illuminate Source 2 Available LED when preset voltage and frequency levels are reached.

8. Verify the phase to phase voltages at Source 1 line terminals.
9. Verify that the phase rotation of Source 1 is the same as the phase rotation of Source 2. 
10. Shut down the generator's engine.
11. Place the starting control in the Automatic position.
12. Complete the visual inspection of the transfer switch.
13. Close the enclosure.
14. Lock the enclosure.

Initial Energization

Before proceeding, refer to the information package supplied with the ATS and read and understand the information on all accessories provided.

1. Unlock the enclosure.
2. Open the enclosure.
3. Verify the correct system voltage.

NOTE: The equipment rating nameplate on the transfer switch lists the voltage. See Figure 3.

4. Close Source 1 circuit breaker.

NOTE: The controller will illuminate Source 1 Available LED if proper voltage is sensed.
5. Verify the phase to phase voltages at the Normal line terminals.
6. Close the Emergency source circuit breaker.
7. Start the generator's engine.

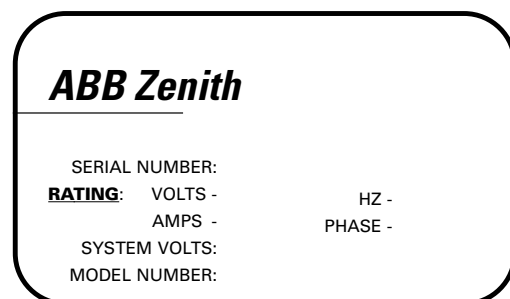

Figure 4

⚠ CAUTIONS ⚠

Certain accessories, per specific schematics, can inhibit automatic transfer. Engine Gen-Set could start when engine control wires are attached.

Installation *(cont'd)*

Initial Energization *(cont'd)*

After all options and accessories are checked and verified, follow these steps to set up the ATS. Refer to MX150 display *Figure 5*. The annunciation LEDs illuminate to indicate (1) source availability, (2) ATS position, and (3) MX150 control function (timing).

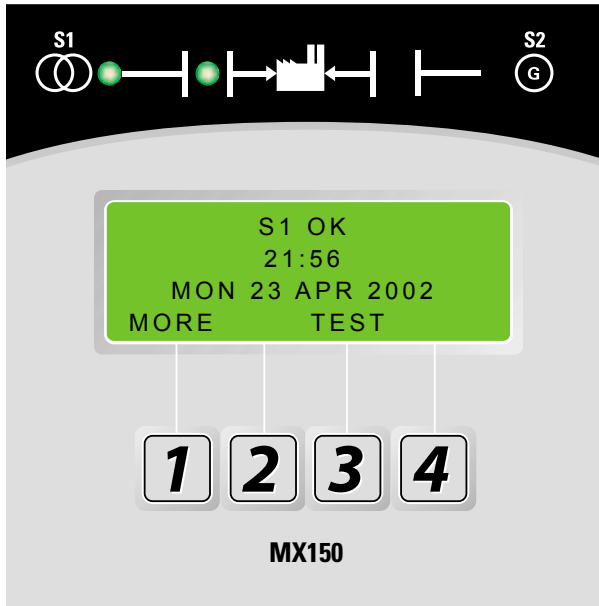

Figure 5 – LCD and keypad

1. Unlock the enclosure.
2. Open the enclosure.
3. Place the Disconnect Switch in the Inhibit.

NOTE: This step is only performed if the "DS" Option was purchased.

4. Close the external (up-stream) Source 1 circuit breaker.

NOTES: Source 1 Available and Source 1 Position LED's will illuminate.

If Source 1 Available LED does not illuminate, verify that Source 1 Voltage is above the preset restore value.

The Gen-Set will start and run while Source 2 stop Delay Timer is timing.

5. Close the External (up-stream) Source 2 line circuit breaker.
6. Start the engine generator in MANUAL mode.

NOTE: When the voltage and frequency reach preset values, the Source 2 Available LED will illuminate.

7. Verify the phase to phase voltages at Source 2 line terminals.
8. Verify that the phase rotation of Source 2 is the same as the phase rotation of Source 1.
9. Shut down the generator's engine. (Place in Automatic Mode.)

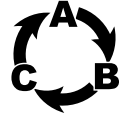

NOTE: Source 2 Available LED will turn off.

NOTE: The engine generator will continue to run for the duration of Source 2 Stop Delay Timer.

10. Place the disconnect switch to ENABLE.
11. Complete the visual inspection of the transfer switch.
12. Close the enclosure.
13. Lock the enclosure.

⚠ WARNING ⚠

When performing a hi-pot or dielectric test on the power section, DISCONNECT the control panel plugs from the microprocessor to avoid potential damage.

⚠ DANGER ⚠

HAZARDOUS VOLTAGE (Can Cause Severe Injury or Death)

Turn OFF all power before installation, adjustment, or removal of transfer switch or any of its components.

Control Connections

Figure 2

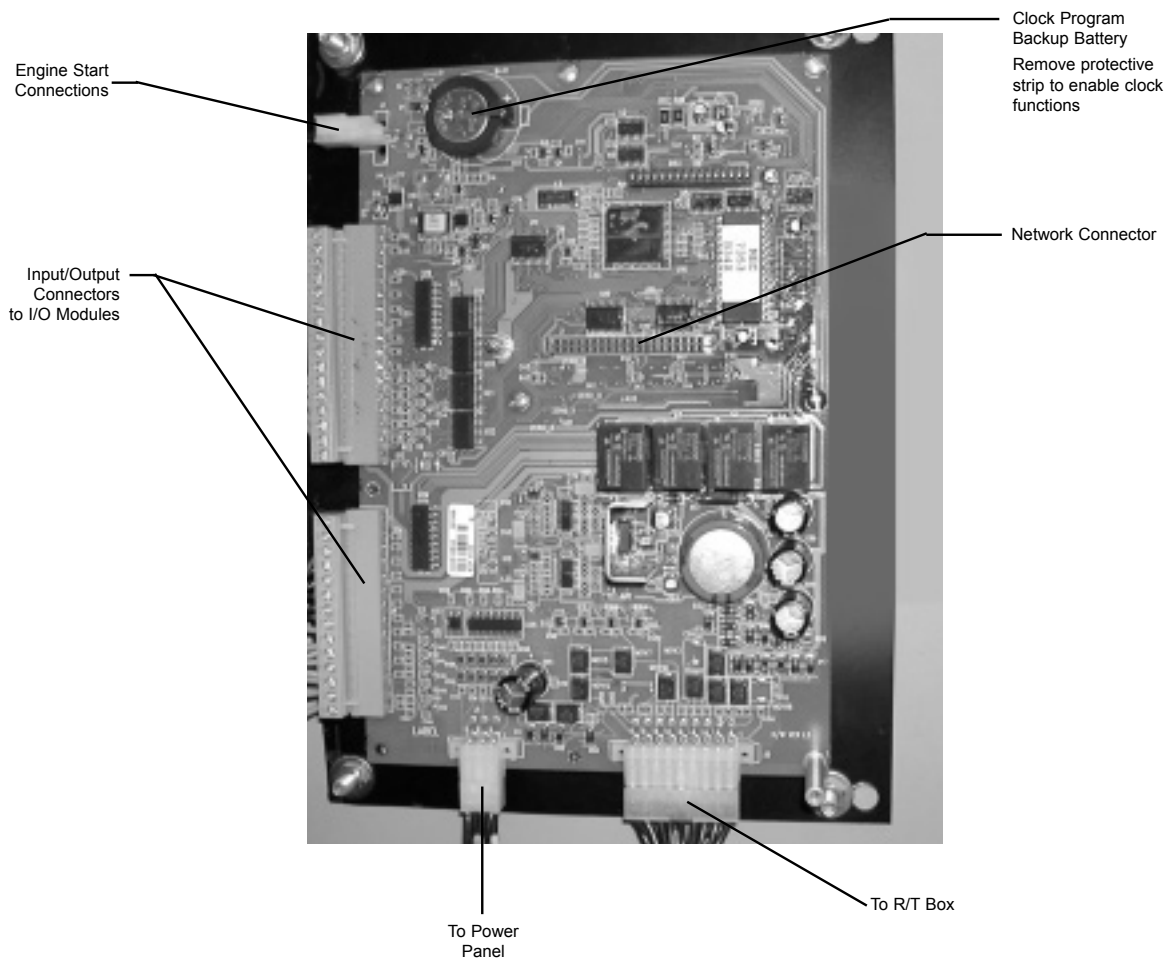

A complete information package is furnished with each transfer switch including a complete connection diagram and schematic which details all necessary control circuit field connections.

The engine start control wires connect to the engine start relay terminals located to the left of the microprocessor. Figure 2 shows the location of these terminals.

The terminals are clearly identified by a label on the microcontroller backplate. In the case of manual transfer switches, or in other applications not requiring the microprocessor, clearly marked terminal blocks are provided in the upper left corner of the control panel for the engine start control wires.

MX150 Microprocessor Controller

MX150 Controller

Consists of two major assemblies:

I. The **Microprocessor** contains the following:

- A. MX150 Board - Customer Input and Output (I/O) for system interface. Located on the left hand side of the back of the unit (see figure 6)
 1. I/O accessories that can be found here are:
 - a. Engine start relay P output
 - b. Pre-Signal to transfer T3, W3 and UMD output (optional)
 - c. Transfer Inhibit Q3 and Q7 input (optional)
 - d. Remote test Q2 input (optional)
 - e. Network interface ZNET input/output (optional)
- B. LCD and Keypad located on the exterior of the door (see figure 7)
 1. User accessibility to the following:
 - a. LED indication of source availability
 - b. LED indication of transfer switch position
 - c. LCD screen indicates:
 - (1) timer count down (numeric)
 - (2) event reporting (text)
 - d. Keypad provides user interface to:
[in conjunction with LCD screen]
 - (1) Setting sensors and timers
 - (2) Configuring logic accessories

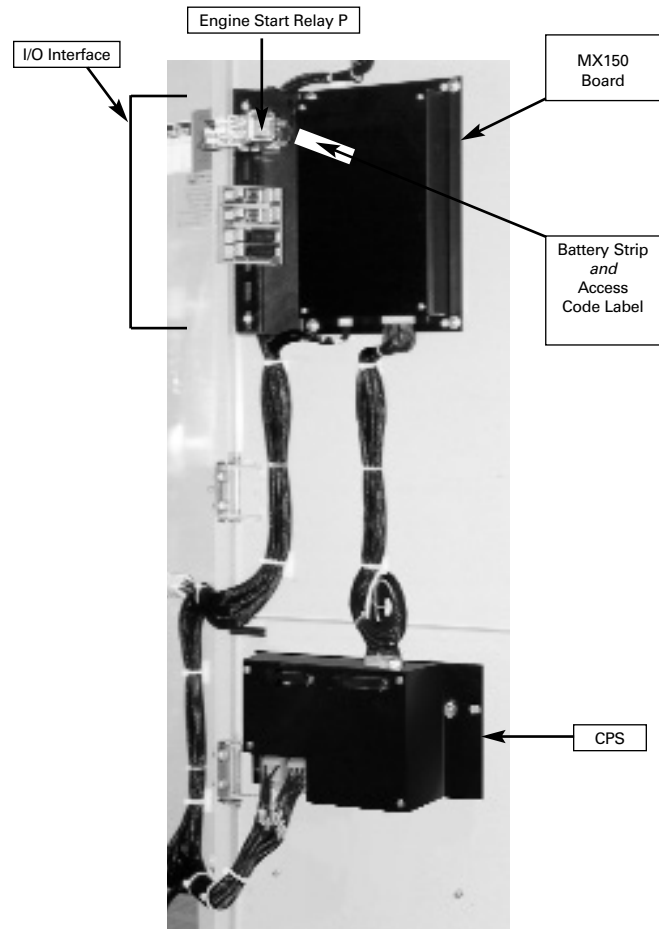

Figure 6

Contains transformers which drop line voltage to control level for controller input and SCR inputs (see figure 6).

II. The **Controls Power Supply (CPS)**

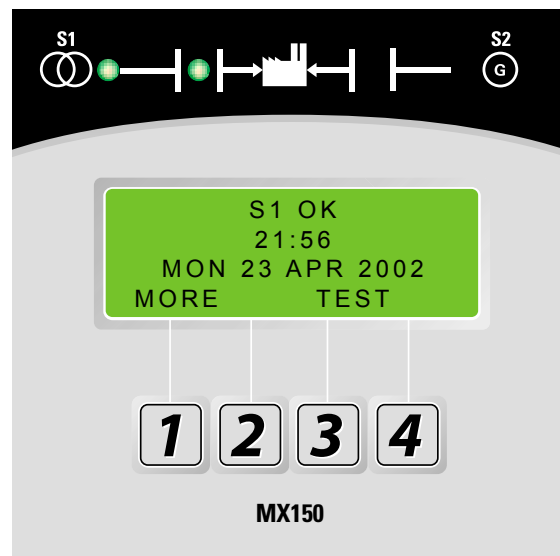

Figure 7

MX150 Microprocessor Controller *(cont'd)*

LCD & Keypad

These options are accessible through the LCD and keypad (see figure below). To become familiar with the options loaded into a particular unit, scrolling through the SET and CFG menu will show the descriptions of the options (see pages 16). These menus are the very same menus that are used to access the setting and/or configuration of these options. The SET (setting) menu is primarily used to show or change, time and voltage settings. The CFG menu is primarily used to turn an option on or off. When scrolling through these menus,

no changes can be made without entry of the access code. The factory set six-digit access code is located on a white label on the back of the unit (see figure 9 pgs. 16-18).

The MX150 has many logic options. Each controller is downloaded with options at the time of manufacture. The collection of options that any one controller has is specified at the time of order placement. The following pages include all the options that can reside in the controller. Not all units include all options.

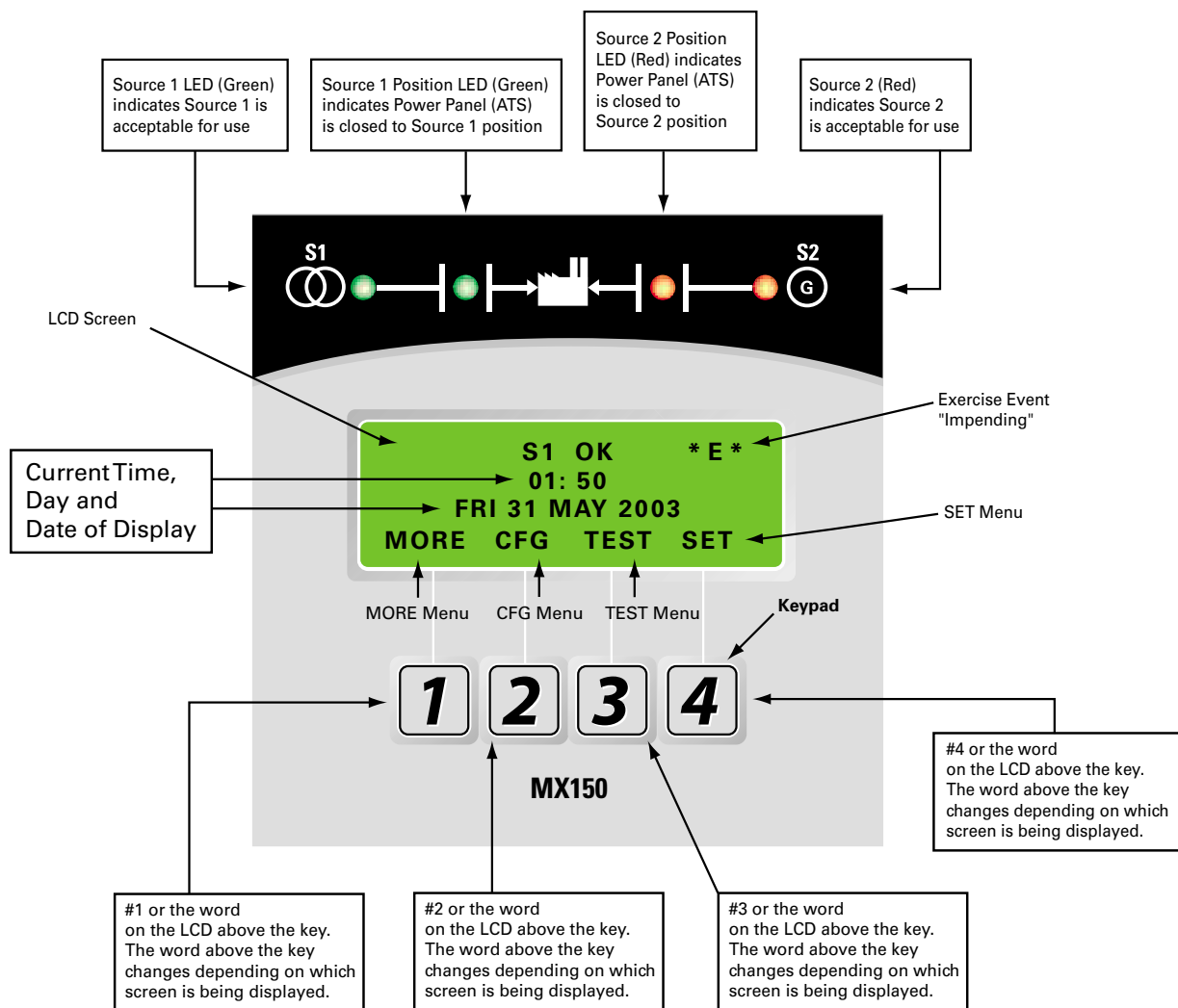

Figure 8

User Setting for Voltage & Frequency

Source 1

Voltage "Restore"

Factory Default: 90%

This adjustment determines the minimum acceptable voltage required to transfer to Source 1.

Adjust via the SET menu. Range is 85% to 100% in 1% increments (see page 17).

Once satisfied, the T timer will begin timing to transfer to Source 1.

Voltage "Fail"

Factory Default: 80%

This adjustment determines the low voltage threshold. Adjust via the SET menu. Range is 75% to 98% in 1% increments (see page 17).

"Fail" must be a minimum of 2 % below "Restore" setting. Once voltage falls below threshold, P timer begins timing to signal Source 2 Generator to start.

Source 2

Voltage "Restore"

Factory Default: 90%

This adjustment determines the minimum acceptable voltage required to transfer to Source 2.

Adjust via the SET menu. Range is 85% to 100% in 1% increments (see page 17).

Once satisfied, the W timer will begin timing to transfer to Source 2.

Voltage "Fail"

Factory Default: 80%

This adjustment determines the low voltage threshold. Adjust via the SET menu. Range is 75% to 98% in 1% increments (see page 17).

"Fail" must be a minimum of 2 % below "Restore" setting. Once voltage falls below threshold, T timer will be bypassed to expedite the transfer to Source 1.

Frequency "Restore"

Factory Default: 95%

This adjustment determines the minimum acceptable frequency required to transfer to Source 2.

Adjust via the SET menu. Range is 90% to 100% in 1% increments (see page 17).

Once satisfied, the W timer will begin timing to transfer to Source 2.

Frequency "Fail"

Factory Default: 90%

This adjustment determines the low frequency threshold. Adjust via the SET menu. Range is 88% to 98% in 1% increments (see page 17).

"Fail" must be a minimum of 2 % below "Restore" setting. Once satisfied, the W timer will begin timing to transfer to Source 2.

Standard Features, MSTDG Option Pkg.

6

Test Switch, Momentary

A3

Auxiliary Contact: Closed when the switch is in Source 2 position.

A4

Auxiliary Contact: Closed when the switch is in Source 1 position.

Calibrate

While monitoring the actual Phase to Phase voltage levels and Frequency with a calibrated test equipment, the Phase to Phase voltage sensing and Frequency can be adjusted accordingly. Calibration capabilities are available for Frequency and AB, BC, CA Phase to Phase voltage for both Sources. Adjust via SET menu (see page 18)

CDT

Load or NO-Load. One event exerciser with adjustable Engine exercise timer. Exercise duration can be set between 5 and 60 minutes in 1 minute increments. Can be configured to run every 1, 7, 14, or 28 days. Factory Default is 20minutes. When exerciser is impending, (*E*) appears in the upper right hand corner of LCD screen. See page 13-14 for instructions. Configured via CFG (see page 16). Set via SET menu (see page 17).

DS

Disconnect Switch, Auto/Inhibit.

Inhibits transfer in either direction when in inhibit.

Allows automatic operation when in Auto.

(800-4000 Amp units)

DT (Delayed Transition Only)

Time Delay from Neutral Switch position to Source 1 position. Adjustable 0-10 minutes in 1 second increments. Standard setting is 5 seconds Adjust via SET menu (see page 17)

DW (Delayed Transition Only)

Time Delay from Neutral Switch position to Source 2 position. Adjustable 0-10 minutes in 1 second increments. Standard setting is 5 seconds. Adjust via SET menu (see page 17)

E

Engine Start Contact

Std. Features, MSTDG Option Pkg. (cont'd)

EL/P

Event Log: Sequentially Numbered Log of 16 events that track date, time, reason and action taken

System Data: Total Life Transfers (N2P)
Days Powered Up
Total Transfers to S2
Total S1 Failures
Time S1 available in Hrs
Time S2 available in Hrs. (N1P)

K/P

Frequency Indication for S1 and S2

L

LNP Center-off position LCD-Indicator
Indicating LED lights:

- L1** Indicates Switch in Source 2 position.
- L2** Indicates Switch in Source 1 position.
- L3** Indicates Source 1 available.
- L4** Indicates Source 2 available.

P1

Time Delay Source 2 Start. Adjustable 0-10 seconds. Standard setting is 3 seconds.
Adjust via SET menu (see page 17)

Q2

Peak Shave / Remote Load Test: Input for Peak Shave or Remote Load Test. Includes automatic return to Source 1 if Source 2 fails and Source 1 present.

R2E

Under voltage sensing of Source 2 for single-phase. (R17 replaces R2E for Utility to Utility switches)

R50

In Phase Monitor this feature restricts **Live to Live Source Transfers** to occur unless both Sources are within 7 electrical degrees or less of each other. (live Source to live Source transfers usually occur during transfer back to Source 1 or during Testing). R50 does not change the operation of the Automatic Transfer Switch in a power failure mode. After all timer functions have elapsed, the **CHECKING FOR SOURCE SYNCHRONISM** will be displayed as well as the direction of transfer (S1-S2 for example denotes transfer from Source 1 to Source2). When synchronism is accomplished, transfer will take place.

- Notes:
- If S2 Frequency is less than S1 Frequency, display will show a series of (-----) symbols.
 - If S2 Frequency is greater than S1 Frequency, display will show a series of (+++++) symbols.
 - Each (-) or (+) symbol represents 10 electrical degrees out of phase. A maximum of 18 symbols (180 electrical degrees) can be monitored.
 - The number of (-) or (+) symbols decrease as the two sources approach synchronism and increase as the two sources drift out of synchronism.
 - If S1 and S2 Frequencies are identical, the display will show a series of alternating symbols (±±±±...) which also indicate the approximate out of phase degrees

In the event that the Sources do not come within 7 electrical degrees of each other within 60 seconds, the unit will display the message: **SYNCH CHECKING** and will allow the user to **BYPASS**. If the **BYPASS** button is pressed, the unit will display the message: **WARNING MAY CAUSE DAMAGE TO THE LOAD**. Pressing **XFR** will actually bypass the R50. Since R50 is a passive device, the length of time it takes to reach Synchronism is dependent on the frequency difference between the two Sources. Source 1 is usually a Utility and the frequency is not within the control of the consumer. Source 2 needs to be adjusted to create an adequate difference in order for the transfer to happen a timely fashion.

Note: For optimum performance, Source 2 Generator should be adjusted a Maximum of 2 Hertz above or below the Utility frequency, minimum of 0.1 Hertz. (58 to 59.9) or (60.1 to 62) Hertz. Adjustment of Generator to 60Hertz could cause lengthy transfer delay.

R50 Feature can be turned ON or OFF via CFG Menu (see page 16). Factory Default if OFF.

S13

Transfer Commit. Configured via CFG menu. (see page 16) When this Feature is set to OFF: The transfer Switch is not committed to transfer unless the outage duration is longer than the timers that precede the transfer to Source 2 position. This assumes that the outage will be an isolated event. When this Feature is set to ON: The transfer Switch is committed to transfer to Source 2 position once the W timer has begun timing, even if Source 1 power returns before the transfer to Source 2. This is to ensure that the transfer takes place, because one outage may be followed by another.

T

Time Delay (S1) Source 1 Stable Timer. To delay transfer to Source 1 (immediate retransfer on Source 2 failure). Adjustable 0-60 minutes in 1 second increments. Standard setting is 30 minutes. Adjust via SET menu (see page 17)

U

(S2) Source 2 Stop Delay Timer. Allows Engine to run unloaded after switch retransfer to Source 1. Adjustable 0-60 minutes in 1 second increments. Standard setting is 5 minutes. Adjust via SET menu (see page 17)

W

Time Delay (S2) Source 2 Stable Timer. To delay transfer to Source 2. Adjustable 0-5 minutes in 1 second increments. Standard setting is 1 second. Adjust via SET menu (see page 17)

YEN

Bypass Timers Key utilizing Keypad. When applicable, the system prompts the user to press a button to bypass (T) or (W) Timers should the user so desires.

Standard Features, MEXEG Option Pkg.

In addition to the features listed under the **MSTDG Option Package**, this enhanced package includes the following features:

A3

Additional Auxiliary contact: closed when switch is in Source 2 position.

A4

Additional Auxiliary contact: Closed when the transfer switch is in Source 1 position.

CDP (replaces CDT)

Clock Exerciser Load/ No Load: Allows the Generator to start and run unloaded or to simulate a power failure, start Generator and run under load.

Can be configured by end user for 1, 7, 14, 28, 365 day cycle.

VI

Voltage Imbalance (Three Phase)

For a three phase source, this feature monitors phase voltage ratios based on a selected range within a selected time window. Should any phase fall below the selected lower window limit or exceed the selected higher window limit within the selected time frame, the controller initiates transfer to the other source.

Range: 5% to 20% of Nominal voltage,
10 to 30 seconds window, user adjustable.

Resolution: 1% Increments

Minimum Differential: 2% between "Fail"
and "Restore" settings.

Factory default: 10% "Fail", 8% "Restore, 30 Seconds.

See CFG Menu page 16 to configure ON or OFF.

See SET Menu page 17 to set Percentage and time windows

Optional Accessories

6A

Test Switch, Maintained / Momentary

6AP

Test Switch, Maintained / Momentary, utilizing Keypad

A1

Auxiliary Contact, operates on Source 1 line failure.

A1E

Auxiliary Contact, operates on Source 2 line failure.

A3

Auxiliary Contacts: Closed when the transfer switch is in Source 2 position.

A4

Auxiliary Contacts: Closed when the transfer switch is in Source 1 position.

A62

Sequential Universal Motor Load Disconnect Circuit. Normally closed Auxiliary contacts for Motor Loads. Open 0-60 seconds prior to transfer, after transfer, or both in either direction then re-close in timed sequence after transfer.

CTAP

Alarm Panel on transfer to Source 2 with Silence button.

DS

Disconnect Switch, Auto/Inhibit. Inhibits transfer in either direction when in inhibit. Allows automatic operation when in Auto. (40-600 Amp units)

HT

Heater and Thermostat.

Manual

Manual Transfer Switch transfers in either direction by depressing designated pushbuttons.

M80

Digital Power Meter with Display: Amps, Volts, and Frequency.

M82

Digital Meter w/Display of Amps, Watts, Volts, Frequency, KVA, KVAR, PF, etc.

M83A

Digital Meter w/Display of Amps, Watts, Volts, Frequency, KVA, KVAR, PF, etc. Plus THD capability w/Modbus.

T3/W3

Elevator Pre-Signal Auxiliary Contacts: Open 0-60 seconds prior to transfer to either direction, re-closes after transfer.

UMD

Universal Motor Load Disconnect Circuit: Auxiliary Contact opens 0-60 seconds prior to transfer in either direction, re-closes after transfer. Can be configured by end user for Pre-transfer, Post-transfer, or both.

VI

Voltage Imbalance (Three Phase)

For a three phase source, this feature monitors phase voltage ratios based on a selected range within a selected time window. Should any phase fall below the selected lower window limit or exceed the selected higher window limit within the selected time frame, the controller initiates transfer to the other source.

Range: 5% to 20% of Nominal voltage, 10 to 30 seconds window, user adjustable.

Resolution: 1% Increments

Minimum Differential: 2% between "Fail" and "Restore" settings.

Factory default: 10% "Fail", 8% "Restore, 30 Seconds. See CFG Menu page 16 to configure ON or OFF. See SET Menu page 17 to set Percentage and time windows

ZNET

Network Communications Interface Card

How to Set the System Clock

How to Set the System Clock

Set System Clock, time and date

- If the clock is not set, the display will show SET SYSTEM CLOCK on the second line of the S1 OK screen.
- The S1 OK screen will show time (hours and minutes) on the second line if the system clock has been set. (Date on third line)

Setting the System Clock

(Start from S1 OK screen)

1. Remove battery protective white plastic strip near **P** relay. *
2. Press **MORE** then press **SET**.
3. Press **MORE** and scroll to **SET SYSTEM CLOCK** using the **MORE** key.
4. Press **SEL**.
5. **ENTER ACCESS CODE** located on the white label on the back of the controller.
6. Press **SEL**.
7. Use the up and down keys to change the hour value.
8. Press **SAVE** (this will enter this value and move cursor to minutes).
9. Use the up and down keys to change the minutes.
10. Press **SAVE** (this will enter this value and move cursor to month).
11. Use the up and down key up to change the month.
12. Press **SAVE** (This will enter this value and complete the clock setting).
13. Use the up and down keys to change the date.
14. Press **SAVE** (this will enter this value and move cursor to year).
15. Use the up and down keys to change year.
16. Press **SAVE** (this will enter this value and complete the clock setting).
17. To edit settings, press **SEL** and repeat steps 6-16.
18. If the setting is satisfactory, press **MORE** (unit then returns to the **SET** menu then press **BACK**, then **ESC**.)

* Replacement battery part #K-4100
Battery will last 5 years and provides power to retain clock function only (Controller functions without battery).

CDT One Event Timer Exerciser

Load / No-Load

One event Exerciser with adjustable Timer. Exercise duration can be set between 5 and 60 minutes in 1 minute increments. Can be configured to run every 1,7,14, or 28 days. Factory default is 20 minutes.

How to CONFIGURE (CFG) and Set (SET) the Timer Exerciser

1. Beginning from the S1 OK screen, press **MORE** then **CFG**.
2. Press **MORE** to scroll to **CONFIG TIMER EXERCISER** screen.
3. The third line of the **CONFIG TIMER EXERCISER** will show either **DAILY**, **WEEKLY**, **14 DAY**, **28 DAY**, or **OFF**.
4. If the third line of the **CONFIG TIMER EXERCISER** shows **DAILY**, **WEEKLY**, **14 DAY**, or **28 DAY** as desired, then proceed to step 10.
5. If the third line of the **CONFIG TIMER EXERCISER** shows **OFF** or if another timer selection is desired, continue.
6. Press **SEL**.
7. Enter **ACCESS** code located on white label on the back of the controller.
8. Press **UP** or **DOWN** to select **DAILY**, **WEEKLY**, **14 DAY**, or **28 DAY** as desired.
9. Press **SAVE**.
10. Press **MORE** to scroll to **CONFIG TIMER EXERCISER (XFR)** or **(NO XFR)**.
11. Press Up or Down to select **XFR** (Load Transfer) or **NO XFR** (No Load Transfer).
12. Press **SAVE**.
13. Press **MORE** repeatedly to **BACK** then **S1 OK** screen.

Set (SET) the Exerciser:

14. Beginning from the S1 OK screen, press **MORE** then **SET**.
15. Press **MORE** repeatedly until **EXER S2 RUN TIME** screen.
16. Press **SEL**.
17. Enter **ACCESS** code located on white label on the back of the controller.
18. Press **SEL**.
19. Cursor is indicated as a line under character to be changed. Change values with up and down keys.
20. Press **SAVE** when complete.
21. Press **MORE** repeatedly until **SET USER SETUP** then press **BACK** then **ESC** to the **S1 OK** screen.

CDT One Event Timer Exerciser *(cont'd)*

How to Initiate CDT Exerciser and to start an exercise cycle every 1, 7, 14, or 28 days

From S1 screen

- 1) Press **TEST**
 - 2) Press **MORE**
 - 3) Press **START TEST TIMER** (to initiate Test).
- If the CDT Exerciser is Factory configured for a Load Exerciser, the Controller will immediately start a load exercise. The controller will start the generator, transfer the load to Source 2 and remain in Source 2 for the duration set for **EXER S2 RUN TIME** in the **SET** menu. The controller will retransfer the load back to Source 1 after the S1 stable timer has timed out and run the generator unloaded for the duration of the S2 stop delay timer (Engine Cool Down Timer).
 - If the CDT Exerciser is Factory configured for a No-Load Exerciser, the Controller will immediately start a No-load exercise. The controller will start the generator and run it unloaded for the duration of the S2 stop delay timer (Engine Cool Down Timer).

Exercise will be repeated at the same time as initiated on every 1, 7, 14, or 28 days according to the selection made in the Configure **CFG** menu.

How to Bypass (Cancel) an exercise during an exercise cycle

- 1) Press **BPASS**
- 2) Allow the controller to complete the Engine cool down cycle

If the CDT Exerciser is Factory configured for a No-Load Exerciser Or allow the controller to complete retransfer to Source 1 If the CDT Exerciser is Factory configured for a Load Exerciser

How to Bypass the next exercise event and Keep the rest of scheduled events unchanged

- 1) Press **Test**
- 2) Press **MORE**
- 3) Press **BYPASS EXER**

To re-institute the next exercise event back, press **CANCL BPASS**

How to initiate a new exercise start time

- 1) Press **TEST**
- 2) Press **MORE**
- 3) Press **EXER CANCL**
- 4) Press **START TIMER TEST**

How to check the next exercise event

- 1) From **S1 OK** screen, press **MORE** three times.
- 2) The unit will display the **PLANT EXERCISER NEXT** event in **DAYS, HOURS, and MINUTES**
- 3) Press **ESC** to **S1 OK** Screen.

Notes:

- ***E*** appears in the upper right hand corner of LCD screen when exercise is impending.
- For Load Exerciser, actual exercise period (ATS in S2 position) = CDT (Exerciser) timing period +T (S1 stable Timer) timing period.

CDP Clock Exerciser

Load / No-Load Clock Exerciser

Allows the Generator to start and run unloaded or to simulate a power failure, start Generator and run under load. Can be configured by the end user for 1, 7, 14, 28, or 365 day cycles.

- A total of 7 independent No Load exercise periods (up to 10 hours each) can be programmed for each of the daily, weekly, 14-day, and 28-day exercisers.
- A total of 12 independent No Load exercise periods (up to 10 hours) can be programmed for the 365-day Exerciser.

How to Configure (CFG) the Exerciser

1. Beginning from the **S1 OK** screen, press **MORE** then **CFG**.
2. Press **MORE** to scroll to **CONFIG CLOCK EXERCISER** screen.
3. The third line of the **CONFIG CLOCK EXERCISER** will show either **DAILY**, **WEEKLY**, **14 DAY**, **28 DAY**, **365 DAY** or **OFF**.
4. If the third line of the **CONFIG CLOCK EXERCISER** shows **DAILY**, **WEEKLY**, **14 DAY**, **28 DAY**, or **365 DAY** as desired, press **MORE** repeatedly to **BACK**. Press **ESC** then proceed to the **SET** menu to set the **EXERCISER**.
5. If the third line of the **CONFIG CLOCK EXERCISER** shows **OFF**, continue.
6. Press **SEL**.
7. Enter **ACCESS** code located on white label on the back of the controller.
8. Press **UP** or **DOWN** to select **DAILY**, **WEEKLY**, **14 DAY**, **28 DAY**, or **365 DAY** as desired.
9. Press **SAVE**.
10. Press **MORE** repeatedly to **BACK** then **ESC** to **S1 OK** screen.

How to set (SET) the DAILY Exerciser

1. Beginning from the **S1 OK** screen, press **MORE** then **SET**.
2. Press **MORE** repeatedly until **SET EXERCISER** screen.
3. Press **SEL**.
4. Enter **ACCESS** code located on white label on the back of the controller.
5. Press **SEL**.

6. Cursor is indicated as a line under character to be changed. Change values with up and down keys. Press **SAVE** after each entry to save value and to move to the next value to be changed.
7. Press **BACK** when complete.
8. Press **MORE** repeatedly until **SET USER SETUP**. Press **BACK** then **ESC** to the **S1 OK** screen.

How to Bypass (Cancel) an exercise during an exercise cycle

- 1) Press **BPASS**
- 2) Allow the controller to complete the Engine cool down cycle.

If the CD Exerciser is configured or Set for a No-Load Exercise. Or allow the controller to complete retransfer to Source 1. If the CD Exerciser is configured for a Load Exerciser

How to Bypass the next exercise event and Keep the rest of scheduled events unchanged

- 1) Press **TEST**
- 2) Press **MORE**
- 3) Press **BYPASS EXER**

To re-institute the next exercise event back, press **CANCL BPASS**

How to check the next exercise event

- 1) From **S1 OK** screen, press **MORE** three times.
- 2) The unit will display the **PLANT EXERCISER NEXT** event in **DAYS**, **HOURS**, and **MINUTES**
- 3) Press **ESC** to **S1 OK** Screen.

Notes:

- In the **S1 OK** screen, an (*E*) appears in the upper right hand corner of LCD screen when exercise is impending.
- For Load Exerciser, actual exercise period (ATS in S2 position)= **CDT** (Exerciser) timing period +T (S1 Stable Timer) timing period.
- A value greater than zero must be entered in the Exerciser duration field to be accepted as a valid exercise period.
- The Exercise cycle will be repeated on a regular basis as programmed and initiated in the **SET** menu depending on what Exerciser was configured (selected) in the **CFG** menu.

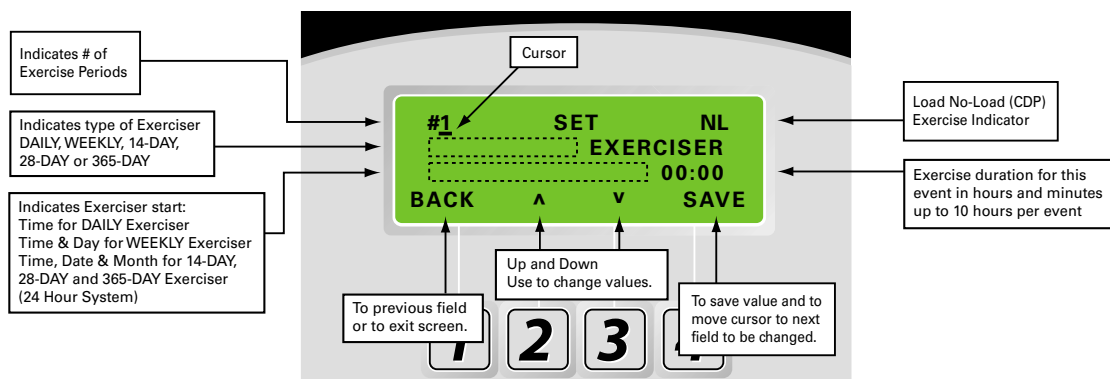

MX150 User Setup - CFG Menu

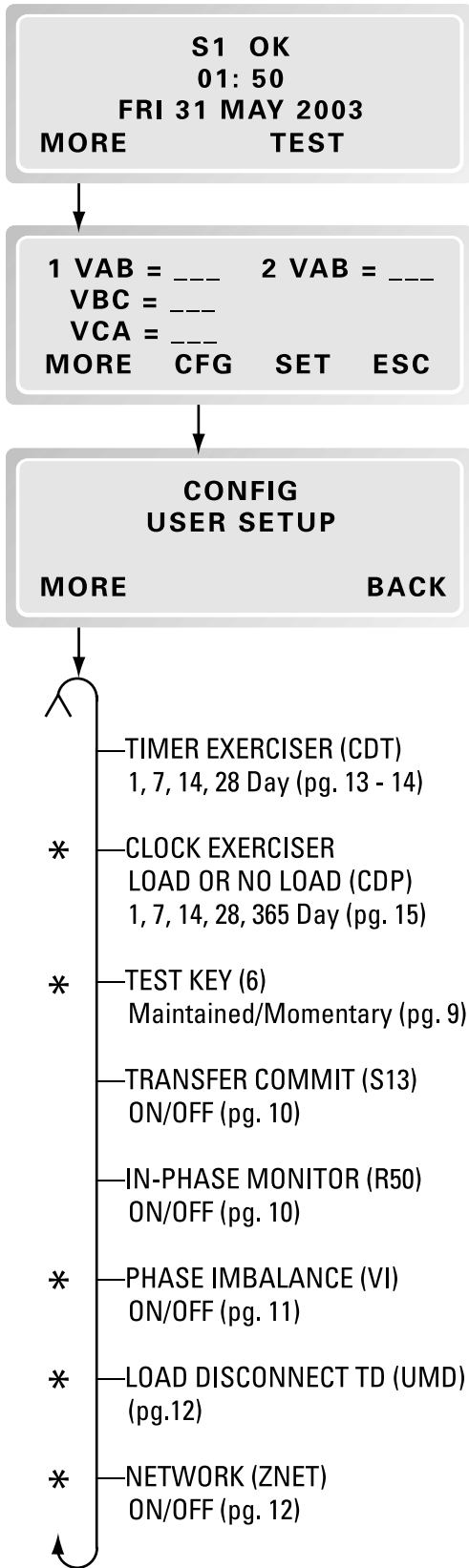

Turn options ON or OFF via keypad through the CFG menu

Enter six digit access code
(The factory assigned six-digit access code is located on the back of the controller)

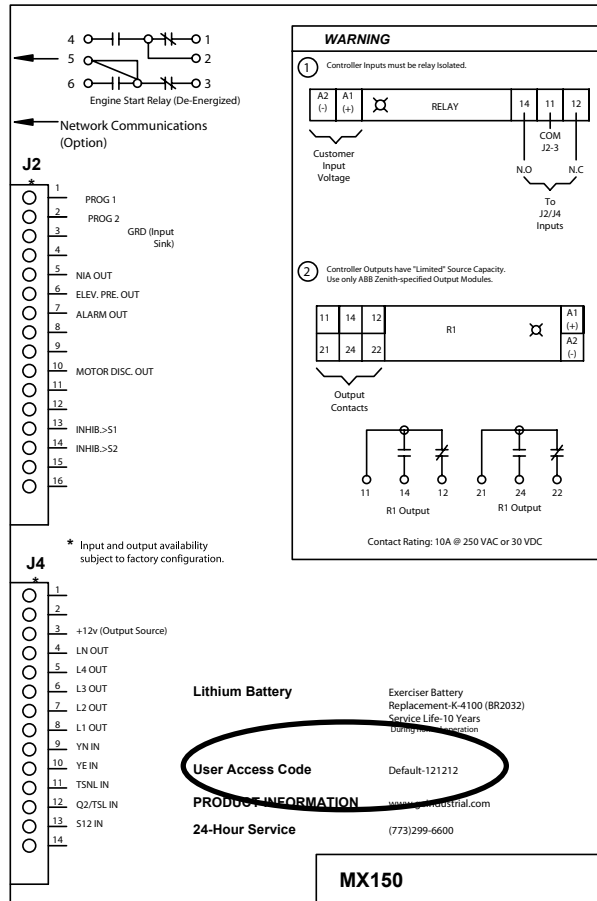
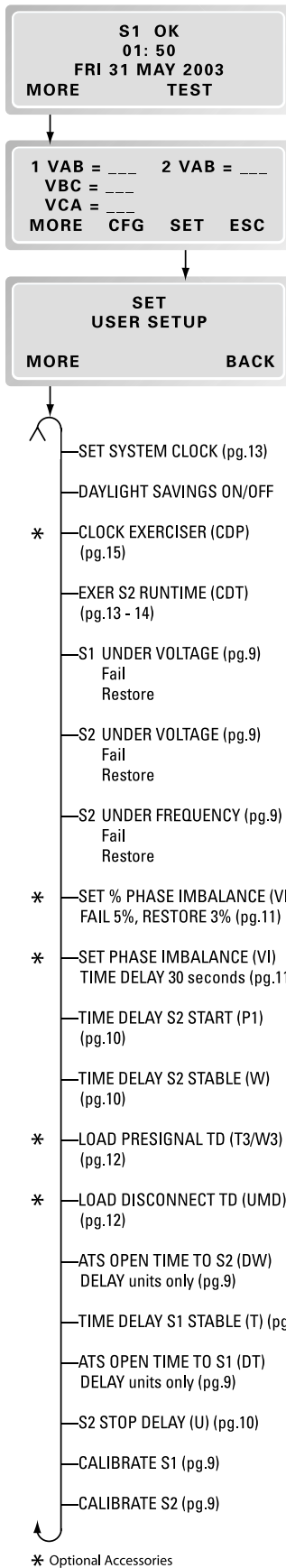

Figure 9

MX150 User Setup - SET Menu



Change adjustable values through the SET menu.

Enter six digit access code
(The factory assigned six-digit access code is located on the back of the controller)

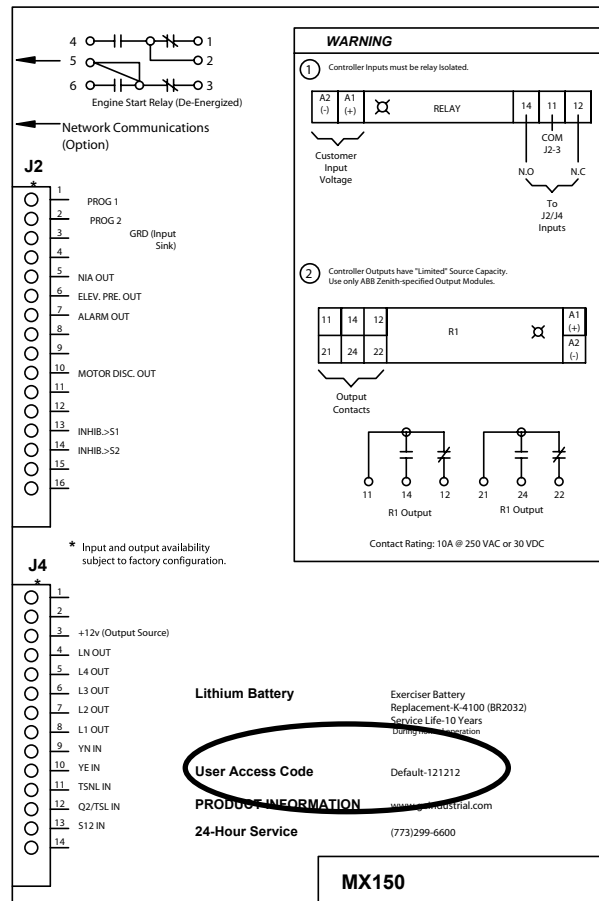

Figure 9

MX150 User Setup - System Info

S1 OK
01: 50
FRI 31 MAY 2003
MORE TEST

- PHASE TO PHASE VOLTAGE, S1 & S2
- FREQUENCY INDICATION FOR S1 & S2 (K/P) (pg.10)
- PLANT EXERCISER:
Next Impending Exerciser (shows only if set)
- SYSTEM INFO:
 - Serial #: Unit Serial #
 - Rev #: Software Revision #
 - Event Log: Sequentially Numbered Log of 16 events that track date, time, reason and action taken
 - Data:
 - Total Life Transfers (N2P)
 - Days Powered Up
 - Total Transfers to S2
 - Total S1 Failures
 - Time S1 available in Hrs
 - Time S2 available in Hrs. (N1P)
- CHANGE USER ACCESS CODE

View System Data

Enter six digit access code
 (The factory assigned six-digit access code is located on the back of the controller)

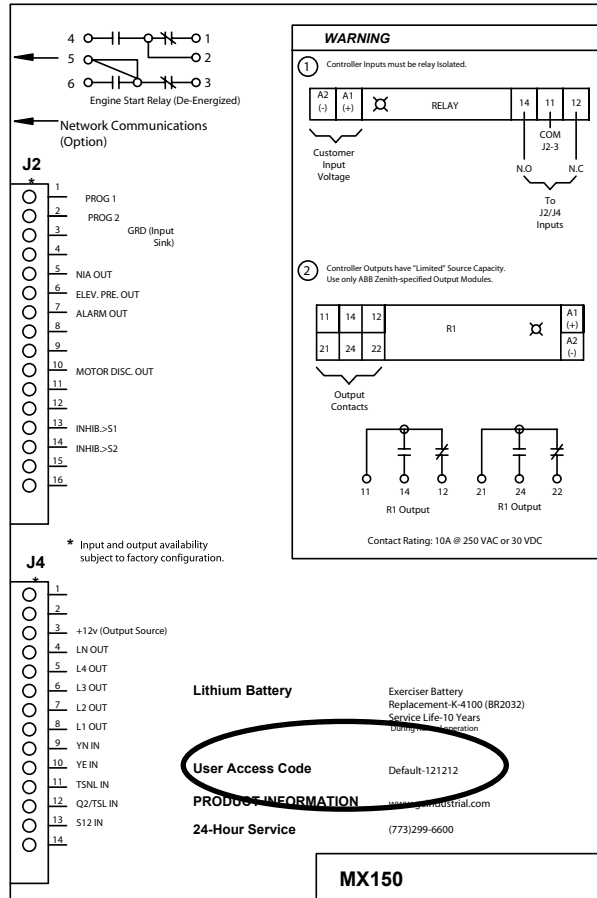

Figure 9

⚠ NOTICE ⚠

A periodic test of the transfer switch under load conditions is recommended to insure proper operation. (See National Electric Code articles 700 and 701)

ATS Testing

Start generator and verify proper voltage, frequency and phase sequence (match to Source 1). Shut down gen set and place in Auto. Complete the visual inspection of the transfer switch, and close the cabinet door.

Initiate the test by pressing the TEST button on the LCD keypad. The controller will then prompt for your access code. After entering the code, three test options will appear—XFR LOAD, FAST TEST and NO XFR (See Figure 10).

- **XFR LOAD** test starts the generator and using the current timer settings, transfers the load to Source 2.
- **FAST TEST** test presets timer values to a maximum 30 seconds during the test. After completion of the test, all timers are reset to their original values. (T3, W3, DT and DW remain)
- **NO XFR** test starts the generator but does not transfer the load to the Source 2.

Press and hold the desired test option button until the switch transfers to Source 2 (load test) or until the generator has been run for the desired amount of time (no load test). Releasing the test button before W timer timeout will abort the test (Exception: when the transfer commit option, is configured "ON").

To test lamps, press TEST then scroll through MORE, then press LAMP TEST. To cancel LAMP TEST press MORE.

Standard Transition

When the test is initiated, the controller initiates the Time Delay Source 2 Start Timer (Engine Start Timer "P") cycle. A manual CANCEL button is provided to cancel the test if desired. Upon completion of the (P) time delay, an Engine start Signal is sent to Source 2. When Source 2 voltage and frequency reach the preset "Restore" Values, the time delay to Source 2 Timer (W) begins its timing cycle to ensure voltage and frequency stabilization before transfer. A manual pushbutton BYPASS is provided to bypass the "W" time delay if desired. After the (W) time delay, the MX controller initiates a transfer signal through the SCR-E to operate the main transfer operator. The load is now transferred to Source 2 line. The transfer switch is mechanically locked. SN limit switch awaits the next operation to Source 1.

Restoration of Source 1 Power:

Deactivating the test switch initiates re-transfer to Source 1 sequence. The delay to Source 1 Timer (T) begins its timing cycle to ensure voltage and frequency stabilization before retransfer. A manual pushbutton BYPASS is provided to bypass the "T" time delay if desired. After the (T) time delay, the MX controller initiates a transfer signal through the SCR-N to operate the main transfer operator. The load is now transferred to Source 1 line. The transfer switch is mechanically locked. SE limit switch awaits the next operation to Source 2.

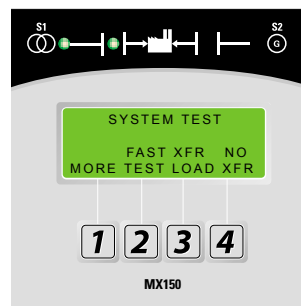

Figure 10

Immediately after re-transfer, the S2 Stop Delay Timer (Delay to Engine Stop "U") begins its cycle to allow Source 2 Engine to run unloaded. A manual pushbutton BYPASS is provided to bypass the "U" time delay if desired. Upon completion of the (U) timing cycle, the controller sends an Engine stop signal.

Delayed Transition

Source 1 Power Failure:

When the test is initiated, the controller initiates the Time Delay Source 2 Start (Engine Start Timer "P") cycle. A manual CANCEL button is provided to cancel the test if desired. Upon completion of the (P) time delay, an Engine start Signal is sent to Source 2. When Source 2 voltage and frequency reach the preset "Restore" values, the time delay to open Source 1 timer (W) begins its timing cycle to ensure voltage and frequency stabilization before re-transfer. A manual pushbutton BYPASS is provided to bypass the "W" time delay if desired. After the (W) time delay, the MX controller initiates a transfer signal through the SCR-NO to operate the main transfer operator. The load is now transferred to the Open position. The time delay to Source 2 timer (DW) begins its timing cycle. After the (DW) time delay, the MX controller initiates a transfer signal through the SCR-E to operate the main transfer operator. The load is now transferred to Source 2 line. The transfer switch is mechanically locked. SN limit switch awaits the next operation to Source 1.

Restoration of Source 1 Power:

Deactivating the test switch initiates re-transfer to Source 1 sequence. The delay to open Source 2 Timer (T) begins its timing cycle to ensure voltage and frequency stabilization before retransfer. A manual pushbutton BYPASS is provided to bypass the "T" time delay if desired. After the (T) time delay, the MX controller initiates a transfer signal through the SCR-EO to operate the main transfer operator. The load is now transferred to the Open position. The time delay to Source 1 timer (DT) begins its timing cycle. After the (DT) time delay, the MX controller initiates a transfer signal through the SCR-N to operate the main transfer operator. The load is now transferred to Source 1 line. The transfer switch is mechanically locked. SE limit switch awaits the next operation to Source 2.

Immediately after re-transfer, the S2 Stop Delay Timer (Delay to Engine Stop "U") begins its cycle to allow Source 2 Engine to run unloaded. A manual pushbutton BYPASS is provided to bypass the "U" time delay if desired. Upon completion of the (U) timing cycle, the controller sends an Engine stop signal.

Sequence of Operation

Standard Transition

Source 1 Power Failure:

When Source 1 voltage or frequency has fallen below the preset "Fail" values, the controller initiates the Time Delay Source 2 Start Timer (Engine Start Timer "P") cycle. Upon completion of the (P) time delay, an Engine start Signal is sent to Source 2. When Source 2 voltage and frequency reach the preset "Restore" Values, the time delay to Source 2 Timer (W) begins its timing cycle to ensure voltage and frequency stabilization before transfer. A manual pushbutton BYPASS is provided to bypass the "W" time delay if desired. After the (W) time delay, the MX controller initiates a transfer signal through the SCR-E to operate the main transfer operator. The load is now transferred to Source 2 line. The transfer switch is mechanically locked. SN limit switch awaits the next operation to Source 1.

Restoration of Source 1 Power:

When Source 1 power reach the preset "Restore" values, the controller initiates re-transfer to Source 1 sequence. The delay to Source 1 Timer (T) begins its timing cycle to ensure voltage and frequency stabilization before retransfer. A manual pushbutton BYPASS is provided to bypass the "T" time delay if desired. After the (T) time delay, the MX controller initiates a transfer signal through the SCR-N to operate the main transfer operator. The load is now transferred to Source 1 line. The transfer switch is mechanically locked. SE limit switch awaits the next operation to Source 2.

Immediately after re-transfer, the S2 Stop Delay Timer (Delay to Engine Stop "U") begins its cycle to allow Source 2 Engine to run unloaded. A manual pushbutton BYPASS is provided to bypass the "U" time delay if desired. Upon completion of the (U) timing cycle, the controller sends an Engine stop signal.

Delayed Transition

Source 1 Power Failure:

When Source 1 voltage or frequency has fallen below the preset "Fail" values, the controller initiates the Time Delay Source 2 Start (Engine Start Timer "P") cycle. Upon completion of the (P) time delay, an Engine start Signal is sent to Source 2. When Source 2 voltage and frequency reach the preset "Restore" values, the time delay to open Source 1 timer (W) begins its timing cycle to ensure voltage and frequency stabilization before re-transfer. A manual pushbutton BYPASS is provided to bypass the "W" time delay if desired. After the (W) time delay, the MX controller initiates a transfer signal through the SCR-NO to operate the main transfer operator. The load is now transferred to the Open position. The time delay to Source 2 timer (DW) begins its timing cycle. After the (DW) time delay, the MX controller initiates a transfer signal through the SCR-E to operate the main transfer operator. The load is now transferred to Source 2 line. The transfer switch is mechanically locked. SN limit switch awaits the next operation to Source 1.

Restoration of Source 1 Power:

When Source 1 power reach the preset "Restore" values, the controller initiates re-transfer to Source 1 sequence. The delay to open Source 2 Timer (T) begins its timing cycle to ensure voltage and frequency stabilization before retransfer. A manual pushbutton BYPASS is provided to bypass the "T" time delay if desired. After the (T) time delay, the MX controller initiates a transfer signal through the SCR-EO to operate the main transfer operator. The load is now transferred to the Open position. The time delay to Source 1 timer (DT) begins its timing cycle. After the (DT) time delay, the MX controller initiates a transfer signal through the SCR-N to operate the main transfer operator. The load is now transferred to Source 1 line. The transfer switch is mechanically locked. SE limit switch awaits the next operation to Source 2.

Immediately after re-transfer, the S2 Stop Delay Timer (Delay to Engine Stop "U") begins its cycle to allow Source 2 Engine to run unloaded. A manual pushbutton BYPASS is provided to bypass the "U" time delay if desired. Upon completion of the (U) timing cycle, the controller sends an Engine stop signal.

Table 3

Timer Designations as they appear in the SET menu						
ATS Type	P	W	DW	T	DT	U
Standard	Time Delay S2 Start	Time Delay S2 Stable	→	Time Delay S1 Stable	→	S2 Stop Delay
Delay	Time Delay S2 Start	Time Delay S2 Stable	ATS Open Time to S2	Time Delay S1 Stable	ATS Open Time to S1	S2 Stop Delay
Source 1 Fails	Transfer to Source 2		↓	Source 1 Returns	Transfer to Source 1	

Controls Power Supply (CPS)

Standard and Delay Transition

Each MX150 microprocessor based ATS controller requires a Controls Power Supply (CPS) to apply line voltage to the ATS operator via SCRs. Also required is power for the MX150 printed circuit board and an application of sensing voltage proportional to line voltage.

This is accomplished by the Controls Power Supply (CPS). This method of switching operator voltage and applying power and sensing voltage to the printed circuit board isolates the MX150 from the line voltage, further protecting the controller from harmful line transients.

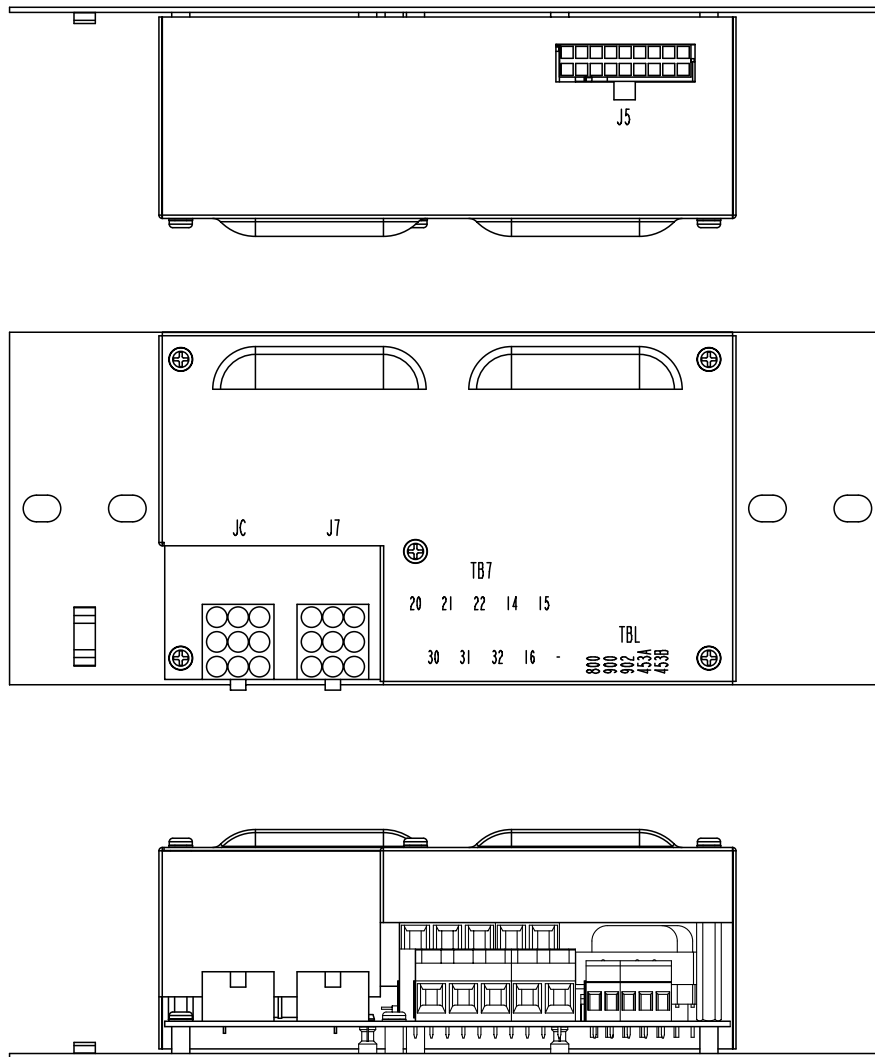

Primary Voltage at 50/60 Hz	CPS Assembly Part No.	CPS Board No.
120V	50P-1224	50P-1200
208-220V	50P-1225	50P-1201
230-240V	50P-1226	50P-1202
277V	50P-1227	50P-1203
380-400V	50P-1228	50P-1204
416-440V	50P-1229	50P-1205
460-480V	50P-1230	50P-1206
575-600V	50P-1231	50P-1207

Controls Power Supply (CPS) *(cont'd)*

Standard Transition CPS Schematic

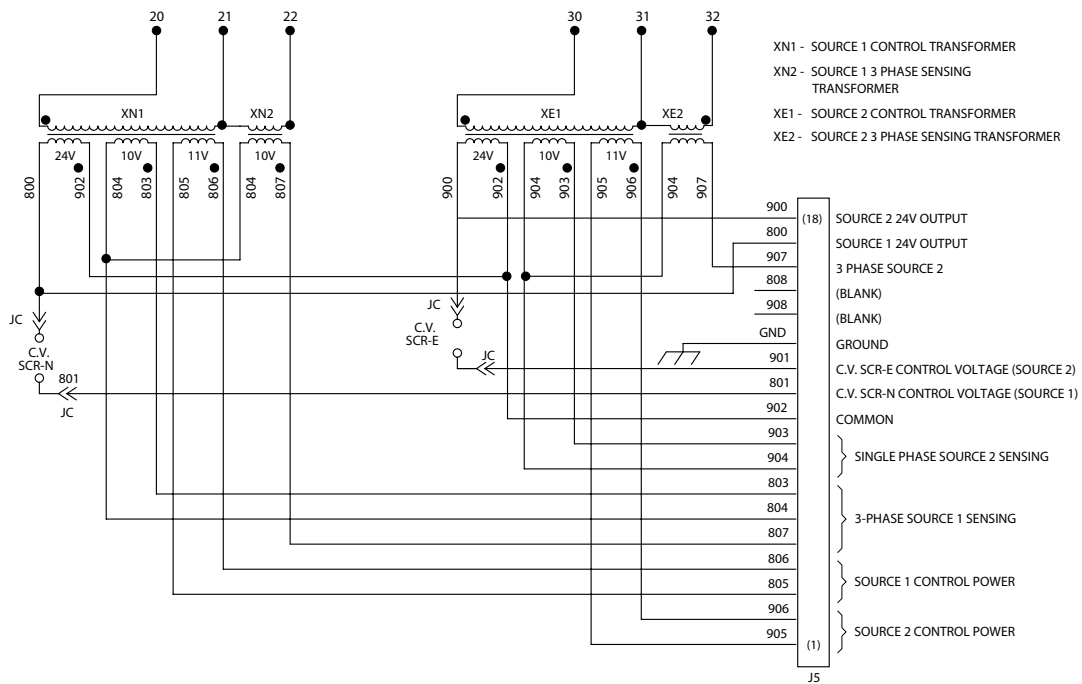

Delayed Transition CPS Schematic

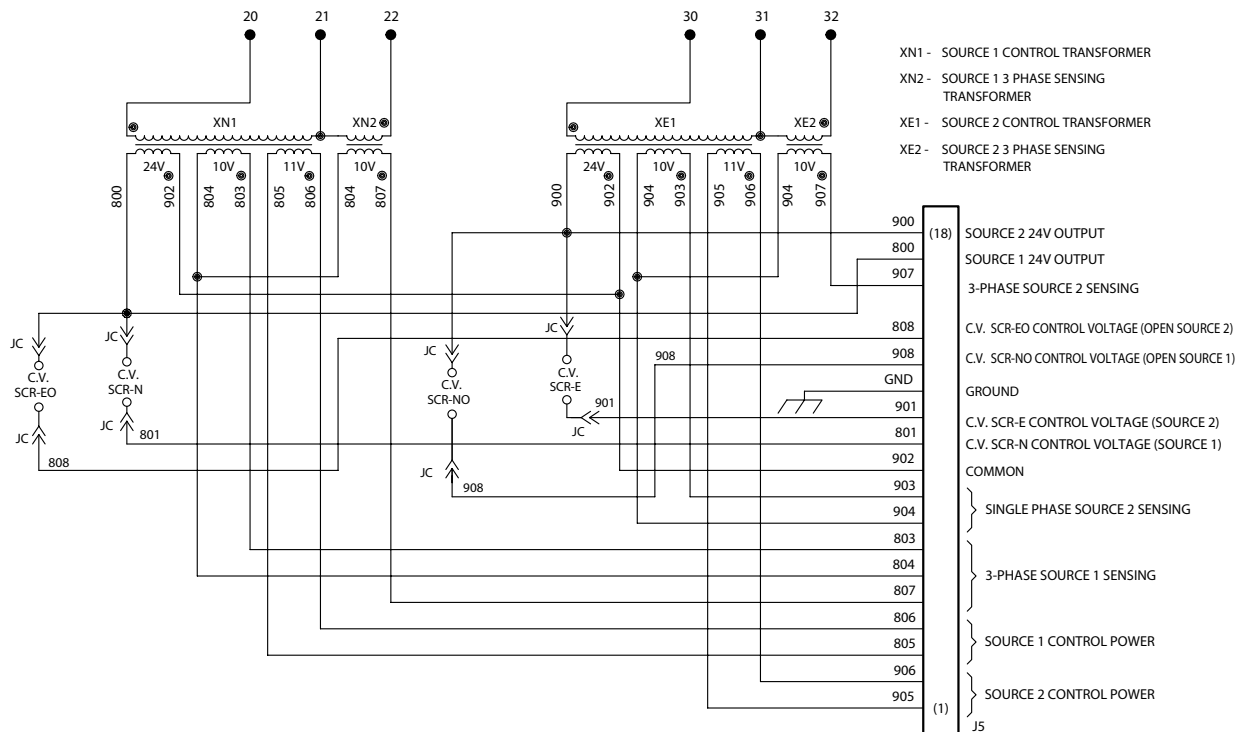

Troubleshooting and Diagnostics

⚠ DANGER ⚠

HAZARDOUS VOLTAGES CAN CAUSE SEVERE INJURY OR DEATH.

These charts may indicate problems that require authorized ABB Zenith service personnel. Hazardous voltages may exist on termination plugs other than those that go into the MX150.

General Troubleshooting

The following troubleshooting guide is used to recognize, and determine basic faults. When using this guide, it will ask several questions about the condition of the switch. This guide will then list an order of the possible faults. You will then look at the first suspected fault to determine if it is the problem. If it is not a fault, you go to the

second suspected fault. If you go through all of the suspected faults, or the chart instructs you to, call an ABB Zenith Representative for further assistance.

NOTE: When you use the troubleshooting charts, the Annunciation column refers to the LED's on the control panel.

Symptom	Annunciation	Possible Cause(s)	Corrective Action
Engine does not START	SOURCE 2 AVAILABLE LED off	Engine start wires not terminated properly	Check engine start connections
		Generator is in OFF position	Investigate why Engine Control Switch was turned off
Engine does not stop	LCD Display - "TD Engine Cool Down"	U timing cycle not complete	Check U timer setting
	SOURCE 1 POSITION, and SOURCE 1 and SOURCE 2 AVAILABLE LEDs on, but U timer has timed out	Engine start wires not terminated correctly	Check Engine Start Connections
ATS will not transfer to SOURCE 2	SOURCE 2 AVAILABLE LED off	SOURCE 2 voltage or frequency not within acceptable parameters	Check: Engine Start Connections, Generator Breaker, Generator Output, and Engine Control Switch
		ZTG Series	None
ZTG Series	LCD Display - "S1 ____ TD XFR S1>S2 Time Remaining ____"	W timing cycle not complete	Check W Timer setting
	ATS will not transfer to SOURCE 1	LCD Display - "ATS Open Time Remaining ____"	DW timing cycle not complete
ZTGD Series	SOURCE 1 AVAILABLE LED off	SOURCE 1 voltage or frequency not within acceptable parameters	Check utility and utility breakers
	None	Power supply connector unplugged	Plug in connector
	LCD Display - "Diagnostic Code 001"	Limit switch or RT box connector unplugged	Call Technical Services
	LCD Display - "S1 OK Time Remaining ____ Bypass"	T timing cycle not complete	Check T Timer setting
	LCD Display - "ATS Open Time Remaining ____"	TD timing cycle not complete	Check DT Timer setting

Maintenance and Testing

⚠ CAUTION ⚠

Due to hazardous voltage and current, ABB Zenith recommends that an ABB Zenith Certified technician or a qualified electrician must perform the installation and maintenance of the switch.

⚠ WARNING ⚠

Both power sources must be disconnected before manual operation of the switch.

A preventive maintenance program will insure high reliability and long life for the transfer switch. The preventive maintenance program for the transfer switch should include the following items:

Inspection and Cleaning

The switch should be inspected for any accumulation of dust, dirt, or moisture, and should be cleaned by vacuuming or wiping with a dry cloth or soft brush. do not use a blower since debris may become lodged in the electrical and mechanical components and cause damage.

Remove the transfer switch barriers and check the condition of the contacts. Any surface deposits must be removed with a clean cloth (do not use emery cloth or a file). If the contacts are pitted or worn excessively, they should be replaced. A general inspection of mechanical integrity should be made to include loose, broken or badly worn parts.

Servicing

All worn or inoperative parts must be replaced using ABB Zenith recommended replacement parts. Please refer to the Replacement Parts manual for specific part information and ordering procedures. Please contact the ABB Zenith Technical Services Department for the Replacement Parts manual.

The operating mechanism of the transfer switch is lubricated with Lubriplate 105. The lubricant applied at the factory provides adequate lubrication for the lifetime of the switch. Should debris contaminate the mechanism, clean and apply additional Lubriplate.

ABB Zenith can provide complete preventative maintenance services. Please contact the ABB Zenith Technical Services Department for additional information.

CDT battery replacement - lithium batteries may last up to 10 years, however it is recommended that battery replacement be included in a 3-5 year service cycle. The battery maintains the exerciser memory only and does not otherwise affect the operation.

Testing

A manual operator handle is provided with the transfer switch for maintenance purposes only. Manual operation of the switch must be checked before it is operated electrically. **Both power sources must be disconnected before manual operation of the switch.** Insert the handle and operate the transfer switch between the Source 1 and Source 2 positions. The transfer switch should operate smoothly without binding. Return the switch to Source 1 position, remove the handle, and return it to the holder provided.

After completing the inspection, cleaning and servicing of the transfer switch, reinstall the switch cover, and close and lock the cabinet door. Reclose the circuit breakers feeding the utility and generator sources to the switch.

Initiate the electrical transfer test by activating the TS test switch. P timer will time out and the microcontroller will send an engine start signal. When the W time has elapsed, the switch will complete its transfer by closing into Source 2.

Deactivating the test switch will start retransfer to Source 1. The switch will complete its retransfer to Source 1 after the time delay of the T timer. The U engine overrun timer allows the engine generator to run unloaded for a preset cool down period.

NOTE: A periodic test of the transfer switch under load conditions is recommended to insure proper operation. (See National Electric Code articles 700 and 701).

⚠ WARNING ⚠

When performing a hi-pot or dielectric test on the power section, DISCONNECT the control panel plugs from the microprocessor to avoid potential damage.

ABB Zenith Controls, Inc.

305 Gregson Drive
Cary, NC 27511

24-hour support:

ABB Technical Services
+1 (800) 637-1738
epis.pqs-service@abb.com

new.abb.com/low-voltage

70R-2000D

15CC303030M0201 08/19