

DE	Bedienungsanleitung	1
GB	Operating Manual	22
FR	Mode d'emploi	42
IT	Istruzioni per l'uso	62
ES	Instrucciones de uso	82
PT	Manual de instruções	102
NL	Bedieningshandleiding	122
CZ	Návod k obsluze	142
SE	Bruksanvisning	162
NO	Bruksanvisning	182

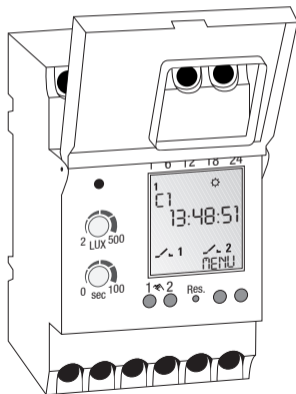



## Inhaltsverzeichnis



**Sicherheitshinweise ..... 4**



**Angaben zum Gerät ..... 5**

Gerätebeschreibung..... 5

Bestimmungsgemäße Verwendung ..... 5

Technische Daten ..... 6



**Installation und Montage ..... 7**

Montage auf DIN-Schiene ..... 7

Anschluss und Montage des Helligkeitssensor ..... 7

Anschlussplan ..... 8

Inbetriebnahme ..... 9



**Bedienung und Einstellung ..... 10**

Display-Anzeige und Funktionstasten ..... 10



Menüstruktur ..... 13

Erstinbetriebnahme – Wahl der Menüsprache ..... 14

Datum und Uhrzeit einstellen ..... 14

Umschalten Sommer-/Winterzeit ..... 15

Programm erstellen ..... 16

Programm anschauen und bearbeiten ..... 18

Programme löschen..... 19

Automatischer/manueller Betrieb..... 20



**Entsorgung / Recycling ..... 21**



## Sicherheitshinweise



**WARNUNG**

### Lebensgefahr durch elektrischen Schlag!

- ▷ Anschluss und Montage ausschließlich durch Elektrofachkraft!

- Beachten Sie die nationalen Vorschriften und Sicherheitsbedingungen.
- Eingriffe und Veränderungen am Gerät führen zum Erlöschen der Gewährleistung und Garantie.
- Mindestdurchmesser der flexiblen Leitungen für die Anschlussklemmen: 1 mm<sup>2</sup>.  
Maximaldurchmesser: 4 mm<sup>2</sup>

Lesen und beachten Sie diese Anleitung, um eine einwandfreie Funktion des Gerätes und ein sicheres Arbeiten zu gewährleisten.



## Angaben zum Gerät

### Gerätebeschreibung

Dämmerungsschalter

- 1 Kanal oder 2 Kanal
- Einstellbare EIN-/AUS-Schalt-Verzögerung:  
0 – 100 sek.
- Es können bis zu 10 Geräte (20 Kanäle) zu einem Lichtsteuersystem mit nur einem Helligkeitsfühler ausgebaut werden.
- Mit Wochenzeitschaltuhr

### Bestimmungsgemäße Verwendung

- Der Dämmerungsschalter wird verwendet für
  - Beleuchtungen im privat- und gewerblichen Bereich
  - Werbebeleuchtung
  - Straßenbeleuchtung
  - Schaufensterbeleuchtung
  - Parkplatzbeleuchtung
  - Steuerung von Rolläden und Jalousien
- Montage nur auf DIN-Schiene.
- Nur für den Einsatz in trockenen Räumen geeignet!



## Technische Daten

### Schaltleistung:

– ohmsche Last (VDE, IEC)	16 A / 250 V AC
– induktive Last $\cos \varphi$ 0,6	10 A / 250 V AC
– Glüh-/Halogenlampenlast	2600W
– Leuchtstofflampe	1000W
– Max. Schaltleistung AC1 / AC15	3700W / 750W

### Umgebungstemperatur:

– Steuergerät / Helligkeitssensor	-10°C ... + 55°C / -30°C ... + 70°C
-----------------------------------	-------------------------------------

### Schutzart:

– Steuergerät / Helligkeitssensor	IP 20 / IP 65
-----------------------------------	---------------

### Dämmerungsschalter:

– Einstellbereich	2 lx – 500 lx
– Schaltverzögerung	einstellbar: ca. 0-100 s EIN/0-100 s AUS

### Schaltuhr:

– Speicherplätze	50
– Ganggenauigkeit	typ $\pm 1$ s/Tag bei +20°C
– Gangreserve	3 Jahre ab Werk



## Installation und Montage



**WARNUNG**

**Lebensgefahr durch elektrischen Schlag!**

▷ Anschluss und Montage ausschließlich durch Elektrofachkraft!

### Montage auf DIN-Schiene

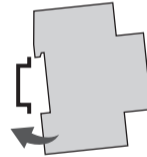

Gerät leicht schräg von oben auf die Schiene setzen. Anschließend nach hinten drücken, bis es einrastet.

### Anschluss und Montage des Helligkeitssensor

1



2

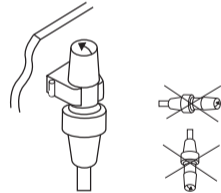

- Länge des Anschlusskabels: max. 100 m
- Leitungsquerschnitt: min. 2 x 0,75 mm<sup>2</sup>



## Anschlussplan



Beim Anschluss des Sensors an die Klemmen + und –, müssen Sie auch zwischen den Klemmen B1 und B2 eine Brücke machen.

Wenn Sie mehrere Geräte mit einem Sensor betreiben, darf diese Brücke nur an einem Gerät gemacht werden.

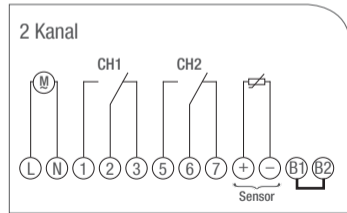
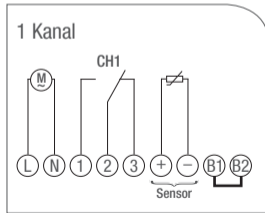

## Inbetriebnahme



Beim Anschluss des Sensors an die Klemmen + und –, müssen Sie auch zwischen den Klemmen B1 und B2 eine Brücke machen.

Wenn Sie mehrere Geräte mit einem Sensor betreiben, darf diese Brücke nur an einem Gerät gemacht werden.

Das Gerät – Dämmerungsschalter und Schaltuhr, schaltet den Ausgang (Klemme 1 und 5) nur aktiv, wenn alle 3 Bedingungen erfüllt sind:

- der eingestellte Helligkeitswert ist unterschritten
- die eingestellte Verzögerungszeit ist abgelaufen
- die Schaltuhr ist auf = EIN

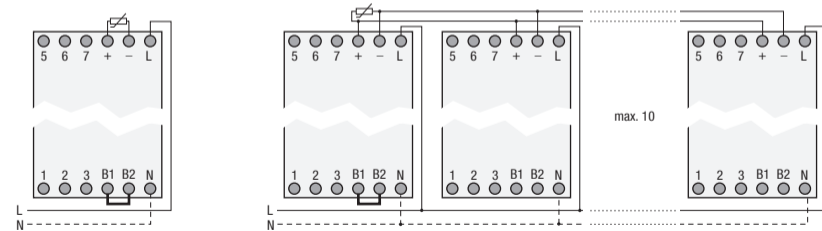



## Bedienung und Einstellung

### Display-Anzeige und Funktionstasten

- Die mittlere Zeile des Displays, welche die einzustellenden Werte und auszuwählenden Menüpunkte zeigt, wird groß dargestellt.
- Blinken signalisiert eine notwendige Eingabe. Erfolgt innerhalb von zwei Minuten keine Eingabe, kehrt die Uhr in den Automatikbetrieb zurück.
- Bei einem Reset bleiben die Programme erhalten. Datum und Uhrzeit müssen Sie neu einstellen. Reset-Taste mit einem stumpfen Gegenstand (Kugelschreiber) betätigen.



### Einstellung des Luxwertes

Einstellknopf auf den gewünschten Lux-Wert (2- 500 Lux) stellen.

- ▷ LED leuchtet, sobald der eingestellte Lux-Wert die Umgebungshelligkeit unterschreitet.

### Einstellung der Verzögerungszeit

Einstellknopf auf die gewünschten Verzögerungszeit (0 - 100 sec) einstellen.

- ▷ Verminderung von Fehlschaltungen durch kurzfristige äußere Lichteinflüsse wie Blitze etc.

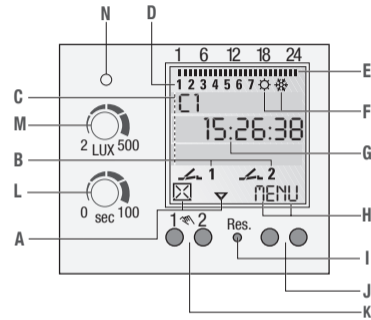

### Display

- A Funktionsanzeigen der beiden linken Tasten
- B Schaltzustandsanzeigen
- C 3 Display-Zeilen
- D Wochentaganzeige
- E Übersicht Tagesschaltprogramm
- F Anzeige Sommer-/Winterzeit
- G Betriebsspannung (permanente Punkte)  
Gangreservebetrieb (Punkte blinken)
- H Funktionsanzeigen der beiden rechten Tasten

### Tasten/Schalter

- I Reset
- J Rechte Tasten
- K Linke Tasten mit Handschalterfunktion im Automatikbetrieb
- L Einstellknopf EIN-/AUS-Schaltverzögerung
- M Einstellknopf Luxwert
- N Schaltzustandsanzeige unverzögert



### Funktionsanzeigen der beiden linken Tasten:

- △ im Menü nach oben blättern
- ▽ im Menü nach unten blättern
- ☒ Auswahl verwerfen
- ✓ Auswahl annehmen
- + Kurz Drücken = +1 / Lang Drücken (ca. 2 sec) = +5
- Kurz Drücken = -1 / Lang Drücken (ca. 2 sec) = -5

### Funktionsanzeigen der beiden rechten Tasten:

- MENU** Verlassen des Automatikbetriebes und Einstieg in den Programmiermodus
- ESC** Kurz Drücken = einen Schritt zurück  
Lang Drücken (ca. 2 sec) = Zurück in den Automatikbetrieb
- OK** Auswahl treffen und übernehmen
- EDT** Ändern der Programme im „Lesen-Modus“
- N** Befehl nicht ausführen
- J** Befehl ausführen
- DEL** Löschen



### Menüstruktur

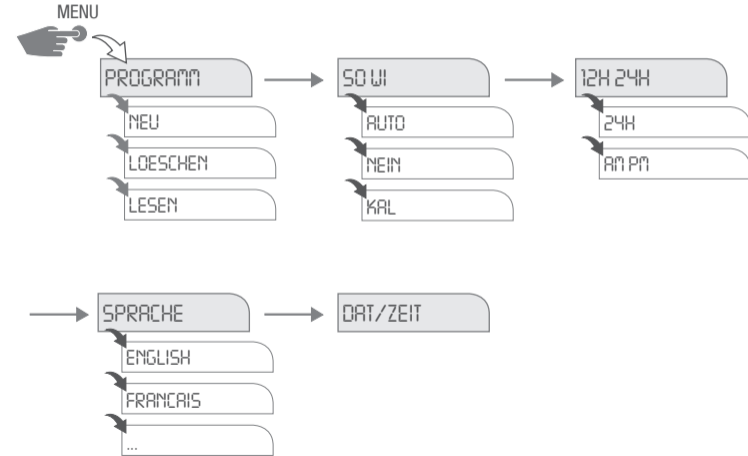



## Erstinbetriebnahme – Wahl der Menüsprache

**i** Im Auslieferungszustand befindet sich die Verteilerschaltuhr im Automatikbetrieb mit voreingestellter Uhrzeit, Datum (MEZ) und englischer Menüsprache. Um Einstellungen vorzunehmen, drücken Sie die Menü-Taste. Anschließend die gewünschte Einstellung wählen.

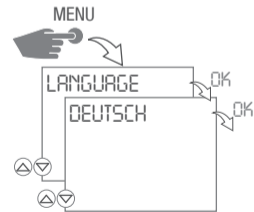

## Datum und Uhrzeit einstellen

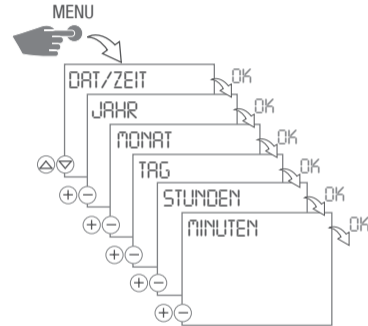

**i** Im Menü **12H 24H** können Sie zwischen AM/PM und der 12/24-Stunden-Anzeige wählen.



## Umschalten Sommer-/Winterzeit

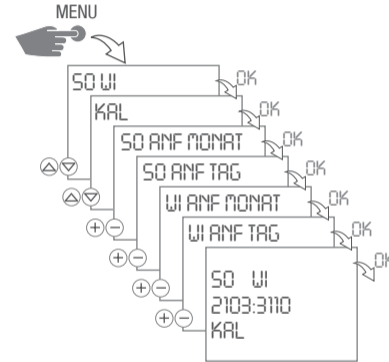

Folgende Einstellungen sind möglich:

### **AUTO**

Werksseitige Voreinstellung der gesetzlichen Vorgabe (MEZ). Diese wird jedes Jahr neu berechnet.

### **NEIN**

Keine Umstellung.

### **KAL**

Manuelle Programmierung. Die werksseitige Voreinstellung wird überschrieben. Die programmierte Sommer-/Winterzeit wird automatisch für jedes Jahr neu berechnet. Die Umschaltung erfolgt am gleichen eingegebenen Wochentag in der gleichen Woche des Monats.





## Programm erstellen

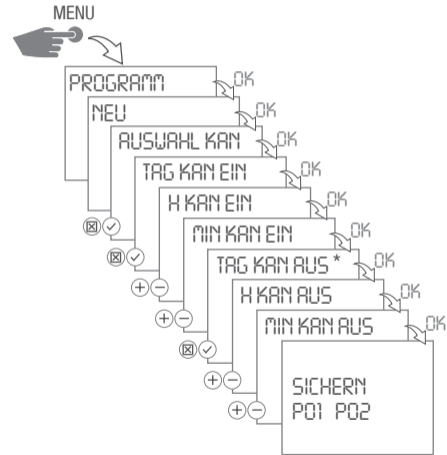

\*) Steht nur zur Auswahl, wenn bei EIN-Befehl Einzeltage ausgewählt werden.



1. Menü-Taste drücken.
2. **PROGRAMM** mit **OK** bestätigen.
3. **NEU** mit **OK** bestätigen.
  - ▷ Die freien Speicherplätze werden kurz angezeigt.
4. Nur bei 2-Kanal-Version:  
Kanal wählen  und mit  bestätigen. → **OK**
  - ▷ Anzeige für Wochentage blinkt.

### EIN-Befehl:

5. Gewünschte Tage wählen  und mit  bestätigen. → **OK**
6. Stunde eingeben (+/-) → **OK**
7. Minuten eingeben (+/-) → **OK**

### AUS-Befehl:

8. Falls gefragt, gewünschte Tage wählen  und mit  bestätigen. → **OK**
9. Stunde eingeben (+/-) → **OK**
10. Minuten eingeben (+/-) → **OK**
  - ▷ Das Programm wird gespeichert.



## Programm anschauen und bearbeiten

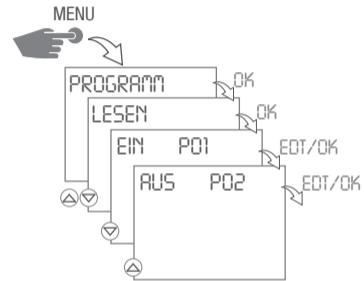

- Mit  $\triangle$   $\nabla$  können Sie die Programmschritte durchblättern.
- Drücken Sie **OK** um zum nächsten Programm zu kommen.
- Drücken Sie **EDT** um das jeweilige Programm zu bearbeiten.  
Die Vorgehensweise entspricht dem Anlegen eines neuen Programms.



## Programme löschen

### Alle Programme löschen

- Drücken Sie **J** um alle Programme zu löschen.
- Drücken Sie **N** um einzelne Programme zu löschen.

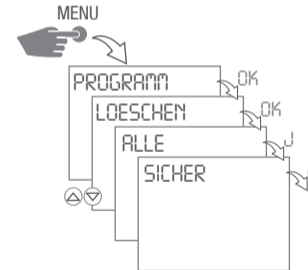

### Einzelne Programme löschen

- Beim Löschen einzelner Programme werden alle dazugehörigen Programmschritte gelöscht (z. B. P01 EIN und P02 AUS).
- Drücken Sie **OK** um zum nächsten Programm zu kommen.

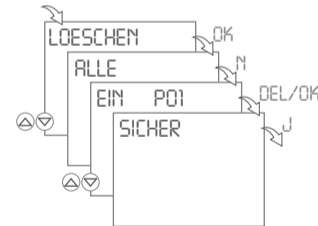



## Automatischer/manueller Betrieb

- Handschalter: Dauer EIN / Dauer AUS / Automatikbetrieb
- Linke Taste = Kanal 1 / Rechte Taste = Kanal 2

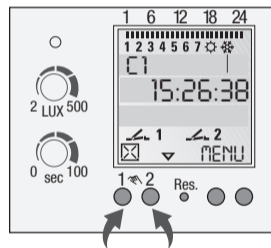

- 1x Drücken = FIX ON = Dauer EIN
- 2x Drücken = FIX OFF = Dauer AUS
- 3x Drücken = Automatikbetrieb

## Schaltzustandsanzeige

— 1 = Kanal EIN

↘ 1 = Kanal AUS

Im Automatikbetrieb erscheint keine Anzeige



## Entsorgung / Recycling





Das Verpackungsmaterial ist nach den gesetzlichen Bestimmungen und Verordnungen sachgerecht zu entsorgen.

Für die Entsorgung defekter Systemkomponenten oder des Systems nach der Produktlebensdauer beachten Sie bitte folgende Hinweise:

- Entsorgen Sie fachgerecht, d.h. getrennt nach Materialgruppen der zu entsorgenden Teile.
- Werfen Sie keinesfalls Elektro- oder Elektronikschrott einfach in den Müll. Nutzen Sie entsprechende Annahmestellen.
- Entsorgen Sie grundsätzlich so umweltverträglich, wie es dem Stand der Umweltschutz-, Wiederaufbereitungs- und Entsorgungstechnik entspricht.



## Table of contents

	<b>Safety instructions.....</b>	<b>24</b>
	<b>Product details.....</b>	<b>25</b>
	Product description.....	25
	Intended use.....	25
	Technical data .....	26
	<b>Installation and assembly .....</b>	<b>27</b>
	Assembly on DIN-rail .....	27
	Connecting and mounting the brightness sensor.....	27
	Wiring diagram .....	28
	Set-up .....	29
	<b>Operation and adjustment .....</b>	<b>30</b>
	Display and function keys .....	30



	Menu structure .....	33
	Initial start-up – Language menu .....	34
	Date and time setting .....	34
	Daylight Saving Time .....	35
	New program.....	36
	View and edit programs .....	38
	Delete program.....	39
	Switching mode.....	40
	<b>Disposal / Recycling .....</b>	<b>41</b>



## Safety instructions



**DANGER**

### **Danger! Risk of electric shock!**

- ▷ Connection and mounting must be realized by a professional electrician!

- Please observe the national regulations and safety instructions.
- Interferences and changes to the device will invalidate the warranty and guaranty rights.
- Minimum diameter of the flexible lines for the terminals: 1 mm<sup>2</sup>.  
Maximum diameter: 4 mm<sup>2</sup>

Read and observe these instructions to guarantee a perfect function of the device and a safe operation.



## Product details

### Product description

Photoelectric switch

- 1 channel or 2 channel
- Adjustable ON/OFF switching delay: 0-100 sec.
- Up to 10 devices (20 channels) can be combined to build a light control system with just one brightness sensor.
- With weekly timer

### Intended use

- The photoelectric switch is used for
  - lighting in private homes and commerce
  - advertising
  - street lighting
  - shop window lighting
  - car park lighting
  - controlling shutters and blinds
- Mounting only on DIN rails.
- Intended only for use in dry areas!



## Technical data

### AC switching capacity:

– Ohmic load (VDE, IEC)	16 A / 250 V AC
– Inductive load cos. $\varphi$ 0,6	10 A / 250 V AC
– Incandescent/halogen lamp load	2600W
– Fluorescent lamp	1000W
– Rated load AC1 / AC15	3700W / 750W

### Ambient temperature:

– Control unit / Brightness sensor	-10°C ... + 55°C / -30°C ... + 70°C
------------------------------------	-------------------------------------

### Protection type:

– Control unit / Brightness sensor	IP 20 / IP 65
------------------------------------	---------------

### Photoelectric switches:

– Adjustment range	2 lx – 500 lx
– Switching delay	adjustable: appr. 0-100s ON/0-100s OFF

### Time switch:

– Memory spaces	50
– Accuracy	typ $\pm$ 1 s/day at +20°C
– Running reserve	3 years from factory



## Installation and assembly



**Danger! Risk of electric shock!**

▷ Connection and mounting must be realized by a professional electrician!

### Assembly on DIN-rail

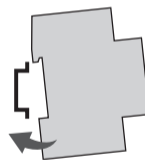

Put the device slightly inclined on top of the rail. Then push it backwards until it engages.

### Connecting and mounting the brightness sensor

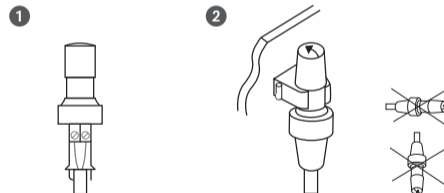

- Length of the connecting cable: max. 100 m
- Line cross-section: min. 2 x 0.75 mm<sup>2</sup>



## Wiring diagram



If you connect the sensor to the + and - terminals, you must connect a jumper between terminals B1 and B2.

If you operate several devices on one sensor, this jumper may only be used for one device.

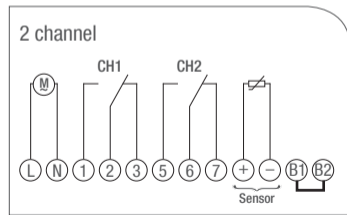
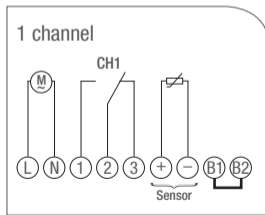

## Set-up



If you connect the sensor to the + and - terminals, you must connect a jumper between terminals B1 and B2.

If you operate several devices on one sensor, this jumper may only be used for one device.

The device - twilight switch and timer - only activates the output (terminals 1 and 5) when all three conditions are fulfilled:

- brightness is lower than the adjusted value
- the adjusted delay time has passed
- the timer is set to = ON

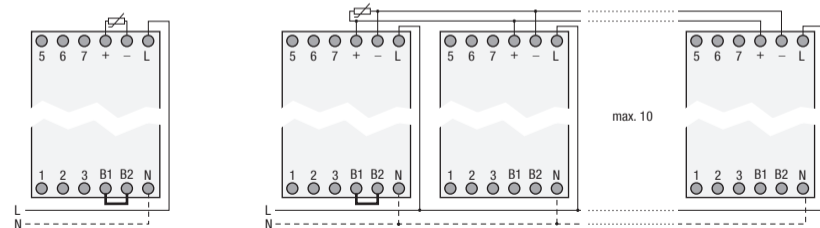



## Operation and adjustment

### Display and function keys

- The central line of the display, in which the adjusted values and selected menu items are displayed, is displayed larger.
- Flashing means that an entry is required. If you do not enter anything within two minutes, the timer switches back to automatic operation.
- The programs are maintained when resetting. You need to readjust date and time. Press the reset button using a blunt object (ball-point pen).

### Adjusting the lux value

Turn the rotary switch to adjust the desired lux value (2-500 lx).

- ▷ The LED is lighted as soon as the surrounding brightness is lower than the adjusted lux value.

### Adjusting the delay time

Turn the rotary switch to adjust the desired delay time (0-100 sec).

- ▷ This reduces incorrect switching due to short-term external light effects, such as lightning, etc.

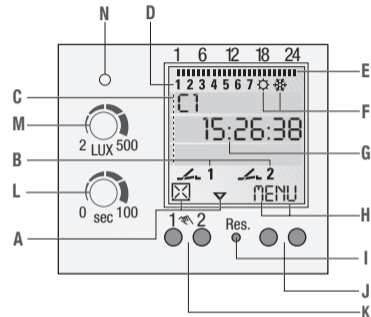

### Display

- A Function displays of the two left-hand buttons
- B Channel status displays
- C 3-line LCD display
- D Day-of-week display
- E Overview of daily switching program
- F Indicates Daylight Saving Time
- G Operating voltage (permanently lit dots)
- H Reserve power operation (dots flash)
- H Function displays of the two right-hand buttons

### Buttons/Switches

- I Reset
- J Right-hand buttons
- K Left-hand buttons with manual switch function in Automatic mode
- L Button for ON/OFF switching delay
- M Button for adjusting the Lux value
- N Switching state display without delay





### Functions of the left-hand buttons:

- △ scroll up in menu
- ▽ scroll down in menu
- ☒ Select/reject suggestion
- ✓ Select/accept suggestion
- + Press briefly = +1 / Press and hold (approx. 2 sec) = +5
- Press briefly = -1 / Press and hold (approx. 2 sec) = -5

### Functions of the right-hand buttons:

- MENU** Exits the Automatic mode and enters the Programming mode
- ESC** Press briefly = one step back  
Press and hold (approx. 2 sec) = return to Automatic mode
- OK** Make selection and apply
- EDT** Change request in "Review mode"
- NO** Do not execute command
- YES** Execute command
- DEL** Delete



### Menu structure

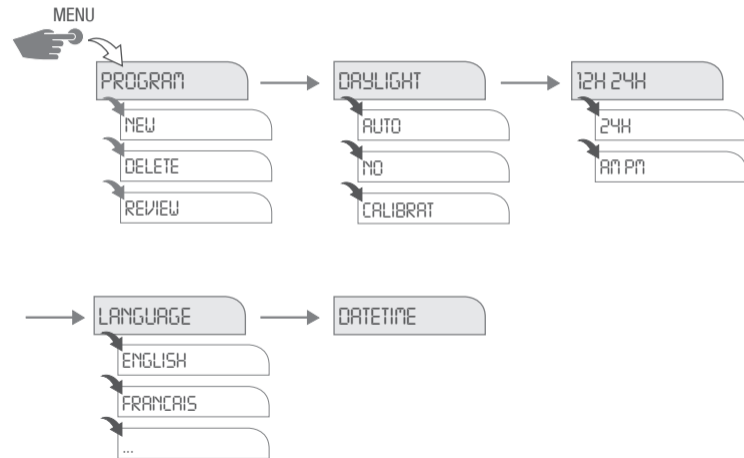



## Initial start-up – Language menu

- i** When delivered, the timer is in automatic mode with preset time, date (CET) and menu in English. Press the Menu button to make settings. Then select the desired setting.

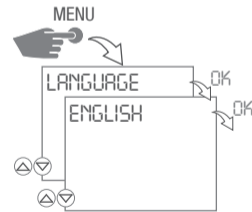

## Date and time setting

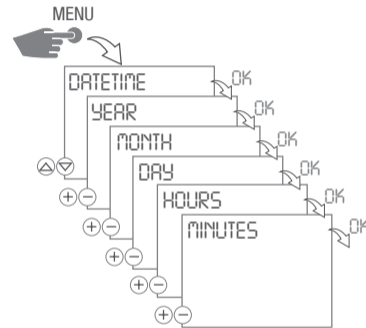

- i** In the menu **12H 24H** you can choose between AM/PM and 12/24-hour announcement.



## Daylight Saving Time

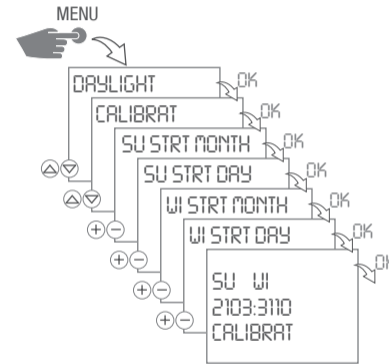

The following settings are possible:

### AUTO

Factory presetting of the published calendar dates (CET). This is automatically recalculated for each year.

### NO

No switchover.

### CALIBRAT

Programming. The start date of the summer time and winter time must be entered for this purpose. The factory presetting is overwritten.

The programmed summer/ winter time is automatically recalculated for each year. The changeover takes place on the same specified day of the week in the same week of each month.



## New program

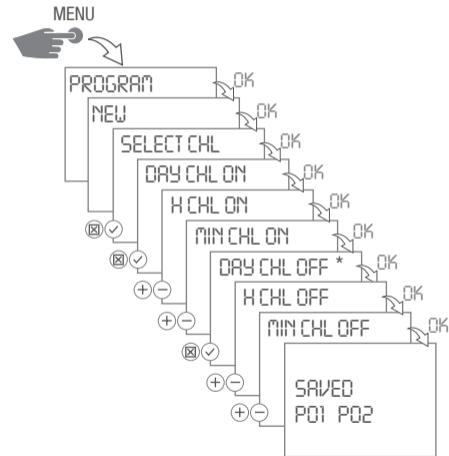

\*) Available only if individual days have been selected for the ON command.



1. Press the Menu button.
2. Confirm **PROGRAM** by pressing **OK**.
3. Confirm **NEW** by pressing **OK**.
  - ▷ Free memory space is briefly displayed.
4. For 2-channel version only:
  - Select a channel  and confirm by pressing **✓**. → **OK**
  - ▷ The weekday display is flashing.

### ON command:

5. Select the desired days  and confirm by pressing **✓**. → **OK**
6. Enter the hours (+/-) → **OK**
7. Enter the minutes (+/-) → **OK**

### OFF command:

8. If requested, select the desired days  and confirm by pressing **✓**. → **OK**
9. Enter the hours (+/-) → **OK**
10. Enter the minutes (+/-) → **OK**
  - ▷ The program is saved.



## View and edit programs

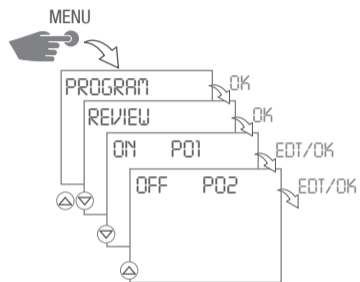

- Press  $\Delta$   $\nabla$  to scroll through the different program steps.
- Press **OK** to get to the next program.
- Press **EDT** to edit a program.  
This procedure is similar to creating a new program.



## Delete program

### Delete all programs

- Press **YES** to delete all programs.
- Press **NO** to delete individual programs.

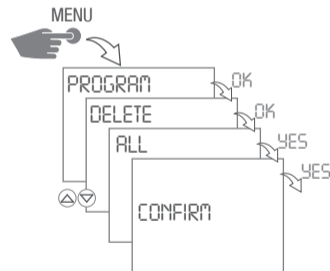

### Delete individual programs

- For deleting individual programs, all belonging program steps are deleted (e.g. P01 ON and P02 OFF).
- Press **OK** to get to the next program.

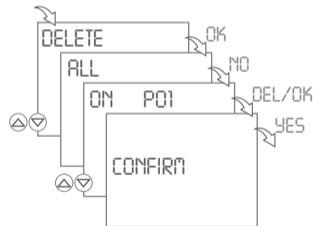



## Switching mode

- Manual switch: duration ON / duration OFF / automatic mode
- Left button = channel 1  
Right button = channel 2

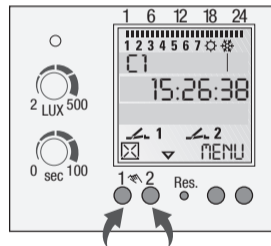

- Press 1x = FIX ON = duration ON
- Press 2x = FIX OFF = duration OFF
- Press 3x = automatic mode

## Channel status displays

— 1 = channel ON

— 1 = channel OFF

There is no display in automatic mode.



## Disposal / Recycling





Dispose of the packing material correctly according to legal requirements and regulations.

Observe the following notes for disposing of defective system components or the system after its service life:

- Dispose of appropriately, i.e. separating the parts to be disposed of according to material groups.
- Do not throw electrical and electronic components in the bin. Bring these parts to the recycling centers.
- Always ensure the environmentally sound disposal conform to the state-of-the-art environment protection, recycling and disposal engineering.



## Table des matières

	<b>Consignes de sécurité .....</b>	<b>44</b>
	<b>Indications concernant l'appareil .....</b>	<b>45</b>
	Description de l'appareil .....	45
	Utilisation conforme à l'emploi prévu .....	45
	Caractéristiques techniques.....	46
	<b>Installation et montage .....</b>	<b>47</b>
	Montage uniquement sur rail DIN.....	47
	Raccordement et montage du capteur de luminosité.....	47
	Schéma de raccordement.....	48
	Mise en service .....	49
	<b>Utilisation et réglage.....</b>	<b>50</b>
	Affichage et touches fonction.....	50



	Structure du menu.....	53
	Première mise en service – Sélection de la langue de menu .....	54
	Régler la date et l'heure.....	54
	Passage heure d'été / d'hiver .....	55
	Créer le programme.....	56
	Regarder et éditer un programme.....	58
	Effacer des programmes.....	59
	Mode automatique/ manuel .....	60
	<b>Elimination des déchets / recyclage.....</b>	<b>61</b>



## Consignes de sécurité



### AVERTISSEMENT

#### Danger de mort par électrocution !

- ▷ Le raccordement et le montage ne doivent être effectués que par des électriciens qualifiés !

- Respectez les prescriptions et consignes de sécurité nationales.
- Toute intervention ou modification sur l'appareil entraîne la perte de la garantie.
- Diamètre minimal des conduites flexibles des bornes de raccordement : 1 mm<sup>2</sup>.  
Diamètre maximal : 4 mm<sup>2</sup>

Lisez et respectez ce mode d'emploi afin de garantir un fonctionnement correct de l'appareil et un travail en toute sécurité.



## Indications concernant l'appareil

### Description de l'appareil

Interrupteur crépusculaire

- 1 canal ou 2 canaux
- Enclenchement et déclenchement temporisés réglables : 0 – 100 sec.
- Au maximum 10 appareils (20 canaux) peuvent créer un système de commande d'éclairage avec un seul capteur de luminosité.
- Avec interrupteur hebdomadaire

### Utilisation conforme à l'emploi prévu

- L'interrupteur crépusculaire est utilisé pour
  - l'éclairage dans le domaine privé et professionnel
  - Eclairage publicitaire
  - Eclairage public
  - Eclairage des vitrines
  - Eclairage de parking
  - Commande de volets roulants et de stores
- Montage uniquement sur rail DIN.
- Uniquement pour une utilisation dans des locaux secs !



## Caractéristiques techniques

Pouvoir de coupure :

- Charge ohmique (VDE, CEI) 16 A / 250 V AC
- Charge inductive cos.  $\varphi$  0,6 10 A / 250 V AC
- Charge/lampe à incandescence/ lampe halogène 2600 W
- Lampe fluorescente 1000 W
- Pouvoir de coupure maximal AC1 / AC15 3700 W / 750 W

Température ambiante :

- Appareil de commande / capteur de luminosité -10°C ... + 55°C / -30°C ... + 70°C

Degré de protection :

- Appareil de commande / capteur de luminosité IP 20 / IP 65

Interrupteur crépusculaire :

- Plage de réglage 2 lx – 500 lx
- Temporisation réglable : env. 0-100 s marche/0-100 s arrêt

Interrupteur horaire :

- Emplacements de mémoire 50
- Précision de marche type  $\pm 1$  s/jour à +20°C
- Réserve de marche 3 ans départ d'usine



## Installation et montage



**AVERTISSEMENT**

**Danger de mort par électrocution !**

- ▷ Le raccordement et le montage ne doivent être effectués que par des électriciens qualifiés !

Montage uniquement sur rail DIN.

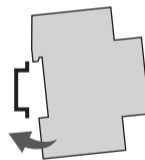

Placer l'appareil légèrement en biais par le haut sur le rail. Pousser ensuite vers l'arrière jusqu'à ce qu'il s'enclenche.

Raccordement et montage du capteur de luminosité

1



2

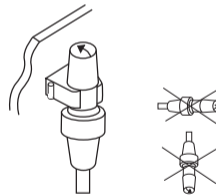

- Longueur du câble de raccordement : max. 100 m
- Section : min. 2 x 0,75 mm<sup>2</sup>





## Schéma de raccordement

- ⚠ Lors du raccordement du capteur aux bornes + et -, vous devez également établir un pont entre les bornes B1 et B2.
- Si plusieurs appareils fonctionnent avec un capteur, ce pont ne peut être établi que sur un appareil.

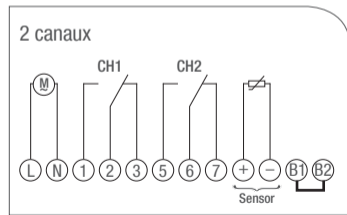
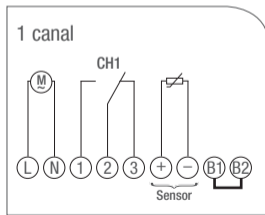

## Mise en service

- ⚠ Lors du raccordement du capteur aux bornes + et -, vous devez également établir un pont entre les bornes B1 et B2.
- Si plusieurs appareils fonctionnent avec un capteur, ce pont ne peut être établi que sur un appareil.

L'appareil (interrupteur crépusculaire avec horloge) commute seulement la sortie (bornes 1 et 5) si les 3 conditions suivantes sont remplies:

- la valeur de luminosité programmée n'est pas atteinte
- le temps de retard programmé s'est écoulé
- l'horloge est sur = MARCHE

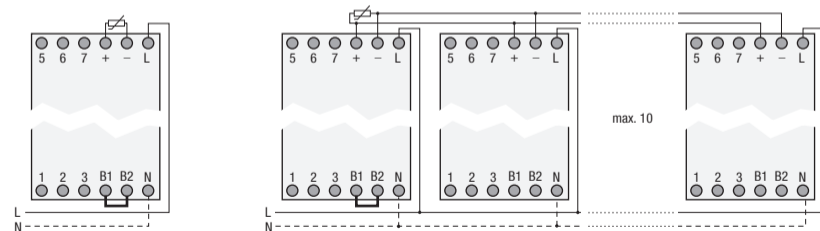



## Utilisation et réglage

### Affichage et touches fonction

- La ligne d'écran intermédiaire indiquant les valeurs à régler et les points de menu à sélectionner est représentée en grand format.
- Le clignotement signale une entrée nécessaire. Si aucune entrée n'est effectuée en l'espace de deux minutes, l'horloge retourne en mode automatique.
- Lors d'une remise à zéro, les programmes sont conservés. La date et l'heure doivent être réglées à nouveau. Appuyer sur la touche Reset avec un objet non pointu (stylo à bille).

### Réglage de la valeur Lux

Régler le bouton de réglage à la valeur Lux souhaitée (2- 500 Lux).

- ▷ La DEL s'allume dès que la valeur Lux réglée n'atteint pas la luminosité ambiante.

### Réglage du temps de retard

Régler le bouton de réglage au temps de retard souhaité (0 - 100 sec.).

- ▷ Diminution des enclenchements intempêtifs dus aux influences extérieures de la lumière à court terme comme les éclairs etc.

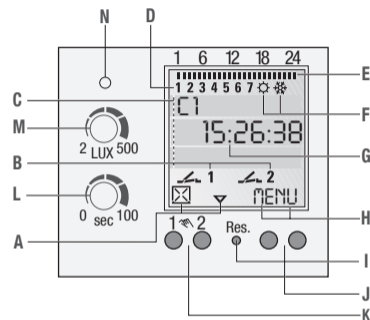

### Touches/interrupteur

- I Reset
- J Touches droites
- K Touches gauches avec fonction de commutation manuelle en mode automatique

### Ecran

- A Affichages de la fonction des deux touches gauches
- B Affichages de l'état de commutation
- C Affichage à 3 lignes
- D Affichage du jour de la semaine
- E Vue d'ensemble programme de commutation journalier
- F Affichage heure d'été /heure d'hiver
- G Tension de service (points permanents) Mode réserve de marche (points clignotent)
- H Affichages de la fonction des deux touches droites
- L Bouton de réglage enclenchement / déclenchement temporisé
- M Bouton de réglage valeur Lux
- N Affichage de l'état de commutation direct



### Affichages de la fonction des deux touches gauches :

- △ défiler vers le haut dans le menu
- ▽ défiler vers le bas dans le menu
- ☒ Supprimer une sélection
- ✓ Accepter une sélection
- + bref appui = +1 / long appui (env. 2 sec.) = +5
- bref appui = -1 / long appui (env. 2 sec.) = -5

### Affichages de la fonction des deux touches droites :

**MENU** Quitter le mode automatique et accès au mode de programmation

**ESC** bref appui = retour d'un pas  
Long appui (env. 2 sec) = retour en mode automatique

**OK** sélectionner et enregistrer

**EDT** modifier les programmes en « mode de lecture »

**NO** ne pas exécuter une instruction

**OUI** exécuter une instruction

**DEL** Supprimer



### Structure du menu

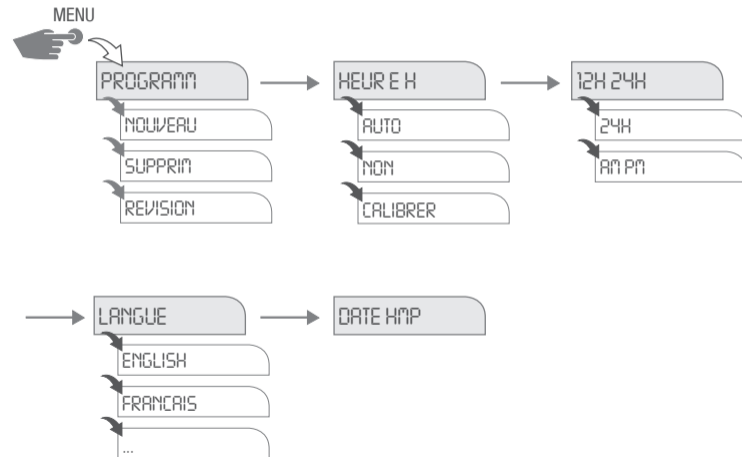



## Première mise en service – Sélection de la langue de menu

**i** À la livraison, l'horloge de distribution est en mode automatique avec heure, date pré-réglées (heure européenne) et avec l'anglais comme langue de menu. Pour procéder aux réglages, appuyez sur la touche de menu. Sélectionnez ensuite le réglage souhaité.

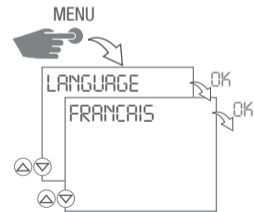

## Régler la date et l'heure

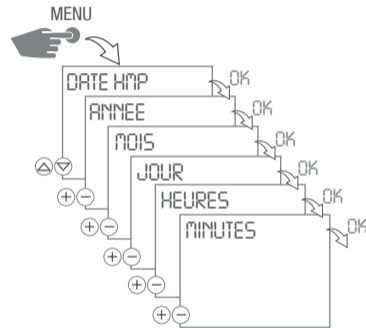

**i** Dans le menu 12H 24H, vous pouvez sélectionner entre AM/PM et l'affichage 12/24.



## Passage heure d'été / d'hiver

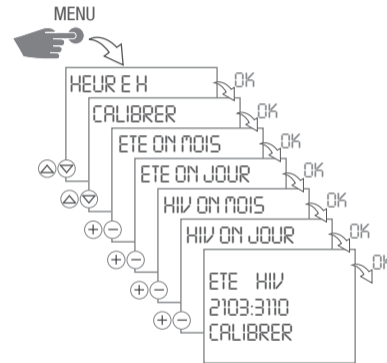

Les réglages suivants sont possibles :

### AUTO

Préréglage effectué à l'usine de l'heure européenne en vigueur. Celle-ci est recalculée chaque année.

### NON

Aucun changement.

### CALIBRER

Programmation manuelle. Le pré-réglage effectué à l'usine est écrasé. L'heure d'été / hiver programmée est recalculée automatiquement pour chaque année. Le passage est effectué au même jour de la semaine entré dans la même semaine du mois.



## Créer le programme

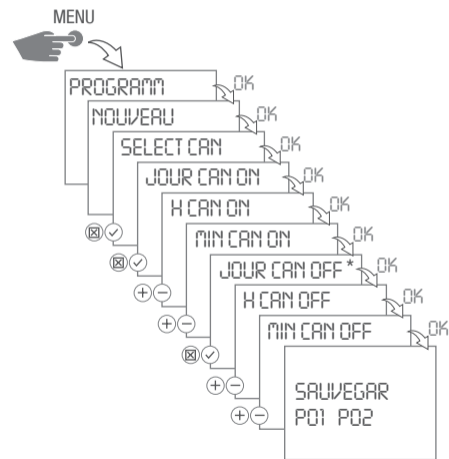

\*) ne peut être sélectionné que si, pour une instruction MARCHE, des jours individuels sont sélectionnés.



- Appuyer sur la touche de menu.
- Valider le **PROGRAMME** par **OK**.
- Valider de **NOUVEAU** par **OK**.
  - Les emplacements de mémoire libres sont affichés brièvement.
- Uniquement pour la version à 2 canaux : Sélectionner le canal  et confirmer par  .  
→ **OK**
  - Affichage des jours de la semaine clignote.

Instruction **MARCHE** :

- Sélectionner les jours souhaités  et confirmer par  . → **OK**

- Entrer l'heure (+/-) → **OK**
- Entrer les minutes (+/-) → **OK**

Instruction **ARRÊT** :

- si nécessaire, sélectionner les jours souhaités  et confirmer par  . → **OK**
- Entrer l'heure (+/-) → **OK**
- Entrer les minutes (+/-) → **OK**
  - Le programme est enregistré.



## Regarder et éditer un programme.

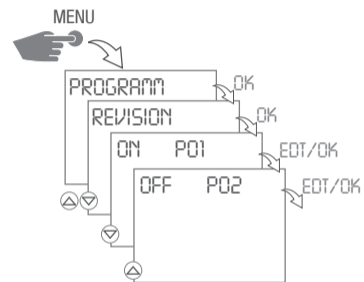

- Avec  $\triangle$   $\nabla$ , vous pouvez faire défiler les étapes du programme.
- Appuyez sur **OK** pour passer au prochain programme.
- Appuyez sur **EDT** pour éditer le programme correspondant.  
La procédure correspond à celle de la création d'un nouveau programme.



## Effacer des programmes

### Supprimer tous les programmes

- Appuyer sur **OUI** pour supprimer tous les programmes.
- Appuyer sur **NO** pour supprimer les programmes individuels.

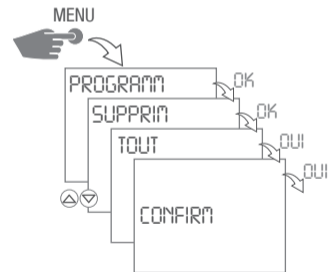

### Supprimer les programmes individuels

- Lors de la suppression des programmes individuels, toutes les étapes de programme correspondantes sont supprimées (par exemple P01 MARCHÉ et P02 ARRÊT).
- Appuyez sur **OK** pour passer au prochain programme

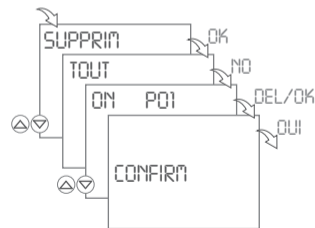



## Mode automatique/ manuel

- Commutateur manuel : Durée MARCHÉ / Durée ARRÊT / Mode automatique
- Touche gauche = canal 1 /  
touche droite = canal 2

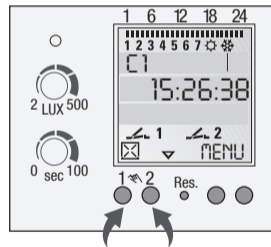

- Appuyer une fois = FIX ON = Durée MARCHÉ
- Appuyer 2 fois = FIX OFF = Durée ARRÊT
- Appuyer 3 fois = Mode automatique

## Affichage de l'état de commutation

- ↗ 1 = Canal MARCHÉ
- ↘ 1 = Canal ARRÊT

Pas d'affichage en mode automatique



## Elimination des déchets / recyclage

Le matériel d'emballage doit être éliminé correctement selon les dispositions et réglementations légales.

Pour l'élimination des composants du système défectueux ou du système après la durée de vie du produit, veuillez respecter les consignes suivantes :

- Eliminez correctement, c.a.d. séparément selon les groupes de matériaux des pièces à éliminer.
- Ne jetez en aucun cas des déchets électriques ou électroniques dans les ordures ménagères. Remettez-les aux postes de collecte correspondants.
- Eliminez en général les déchets en respectant les consignes en vigueur dans le domaine de la technique de protection de l'environnement, de recyclage et d'élimination des déchets.



## Indice



**Avvertenze per la sicurezza ..... 64**



**Indicazioni relative all'apparecchio ..... 65**

Descrizione dell'apparecchio .....65

Uso conforme allo scopo d'impiego previsto .....65

Dati tecnici .....66



**Installazione e montaggio ..... 67**

Montaggio su guida DIN.....67

Collegamento e montaggio del sensore di luminosità.....67

Schema di collegamento.....68

Messa in funzione.....69



**Comando ed impostazione ..... 70**

Indicazione sul display e tasti di funzione.....70



Struttura del menu.....73

Prima messa in funzione – Selezione della lingua del menu.....74

Impostazione della data e dell'ora.....74

Cambio ora legale/solare .....75

Generazione del programma.....76

Visualizzazione e modifica del programma.....78

Cancellazione di programmi.....79

Funzionamento manuale/automatico .....80



**Smaltimento / Riciclaggio..... 81**





## Avvertenze per la sicurezza



### AVVERTENZA

#### Pericolo di morte per scossa elettrica!

- ▷ Il collegamento e il montaggio vanno eseguiti esclusivamente da un elettricista specializzato!

- Osservare le direttive nazionali e le condizioni per la sicurezza.
- Qualsiasi intervento o modifica all'apparecchio comporta la cessazione immediata della garanzia.
- Diametro minimo dei cavi flessibili per i morsetti: 1mm<sup>2</sup>.  
Diametro massimo: 4mm<sup>2</sup>

Leggere e rispettare queste istruzioni per garantire il funzionamento perfetto dell'apparecchio e un lavoro sicuro.



## Indicazioni relative all'apparecchio

### Descrizione dell'apparecchio

Interruttore crepuscolare

- 1 canale o 2 canali
- Ritardo di attivazione ON/OFF regolabile:  
0 – 100 s
- Si possono usare come massimo 10 apparecchi (20 canali) per formare un sistema di regolazione della luce con un solo sensore di luminosità.
- Con timer settimanale

### Uso conforme allo scopo d'impiego previsto

- L'interruttore crepuscolare viene utilizzato per
  - l'illuminazione nel settore privato e commerciale
  - l'illuminazione pubblicitaria
  - l'illuminazione stradale
  - l'illuminazione di vetrine
  - l'illuminazione di parcheggi
  - il comando di serrande e persiane
- Montaggio solo su guida DIN.
- Adatto solo per l'impiego in locali asciutti!



## Dati tecnici

Potere di interruzione:

- carico ohmico (VDE, IEC) 16 A / 250 V AC
- carico induttivo  $\cos \varphi 0,6$  10 A / 250 V AC
- Carico di lampade a incandescenza/alogene 2600W
- Lampada fluorescente 1000W
- Potere max. di interruzione AC1 / AC15 3700W / 750W

Temperatura ambiente:

- Apparecchio di regolazione / sensore di luminosità -10°C... + 55°C / -30°C ... + 70°C

Grado di protezione:

- Apparecchio di regolazione / sensore di luminosità IP 20 / IP 65

Interruttore crepuscolare:

- Gamma di regolazione 2 lx – 500 lx
- Ritardo di attivazione regolabile: ca. 0-100 s ON/0-100 s OFF

Timer:

- Posizioni di memoria 50
- Precisione dell'orologio modello  $\pm 1$  s/giorno a +20°C
- Riserva di carica 3 anni di fabbrica



## Installazione e montaggio



**AVVERTENZA**

**Pericolo di morte per scossa elettrica!**

- ▷ Il collegamento e il montaggio vanno eseguiti esclusivamente da un elettricista specializzato!

### Montaggio su guida DIN

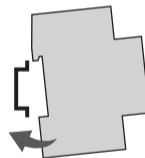

Collocare l'apparecchio dall'alto in posizione leggermente inclinata sulla guida. Spingerlo poi indietro finché non incastri.

### Collegamento e montaggio del sensore di luminosità

1



2

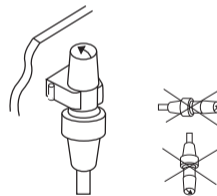

- Lunghezza del cavo di collegamento: max. 100 m
- Diametro del cavo: min. 2 x 0,75 mm<sup>2</sup>



## Schema di collegamento

⚠ Se il sensore viene collegato ai morsetti + e -, si deve collegare anche un jumper tra i morsetti B1 e B2.

Se vengono utilizzati vari apparecchi con un sensore, questo jumper deve essere collegato solo su un apparecchio.

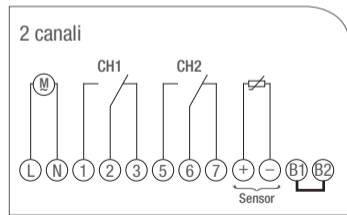
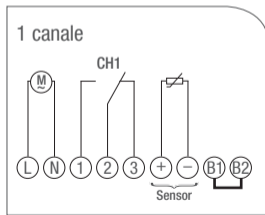

## Messa in funzione

⚠ Se il sensore viene collegato ai morsetti + e -, si deve collegare anche un jumper tra i morsetti B1 e B2.

Se vengono utilizzati vari apparecchi con un sensore, questo jumper deve essere collegato solo su un apparecchio.

L'apparecchio – interruttore crepuscolare e timer – attiva l'uscita (morsetto 1 e 5) solo se vengono soddisfatte le seguenti 3 condizioni:

- la luminosità è inferiore al valore impostato
- è scaduto il tempo di ritardo
- il timer è settato a = ON

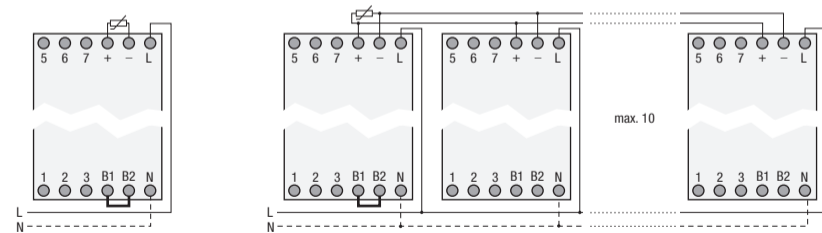



## Comando ed impostazione

### Indicazione sul display e tasti di funzione

- La riga centrale del display che indica i valori da impostare e le voci del menu da visualizzare viene visualizzata in misura più grande.
- Il segno lampeggiante significa che è richiesta un'immissione. Se non viene fatta alcuna immissione entro due minuti, l'orologio torna al funzionamento automatico.
- In caso di un reset, i programmi vengono mantenuti. Si devono regolare di nuovo la data e l'ora. Premere il tasto di reset con un oggetto spuntato (penna a sfera).

### Impostazione del valore di lux

Posizionare il bottone di impostazione sul valore di lux desiderato (2- 500 Lux).

- ▷ Il LED lampeggia non appena il valore di lux impostato sia inferiore alla luminosità ambiente

### Impostazione del tempo di ritardo

Posizionare il bottone di impostazione sul tempo di ritardo desiderato (0 - 100 s).

- ▷ In questo modo vengono ridotti i collegamenti sbagliati dovuti a brevi influssi luminosi esterni come ad es. lampi ecc.

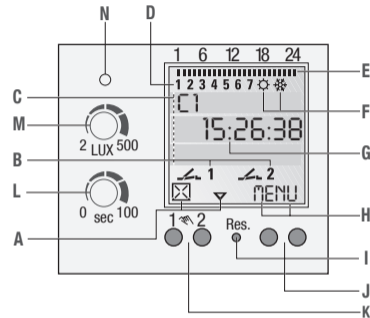

### Tasti/Interruttori

- I Reset
- J Tasti a destra
- K Tasti a sinistra con funzione manuale nel funzionamento automatico

### Display

- A Indicazioni delle funzioni dei due tasti a sinistra
- B Indicazioni degli stati di attivazione
- C 3 righe del display
- D Indicazione del giorno della settimana
- E Panoramica del programma di attivazione giornaliera
- F Indicazione dell'ora legale/solare
- G Tensione di esercizio (punti permanenti) Funzionamento a riserva di carica (punti lampeggiano)
- H Indicazioni delle funzioni dei due tasti a destra
- L Bottone di impostazione del ritardo di attivazione ON/OFF
- M Bottone di impostazione del valore di lux
- N Indicazione degli stati di attivazione senza ritardo



### Indicazioni delle funzioni dei due tasti a sinistra:

- △ scorrere nel menu verso l'alto
- ▽ scorrere nel menu verso il basso
- ☒ respingere la selezione
- ✓ accettare la selezione
- + premere brevemente = +1 / premere a lungo (ca. 2 s) = +5
- premere brevemente = -1 / premere a lungo (ca. 2 s) = -5

### Indicazioni delle funzioni dei due tasti a destra:

- MENU** Uscire dal funzionamento automatico ed entrare nella modalità di programmazione
- ESC** premere brevemente = un passo indietro  
premere a lungo (ca. 2 s) = tornare al funzionamento automatico
- OK** selezionare ed accettare
- EDT** modificare i programmi nella "modalità di lettura"
- NO** non eseguire il comando
- SI** eseguire il comando
- DEL** cancellare



### Struttura del menu

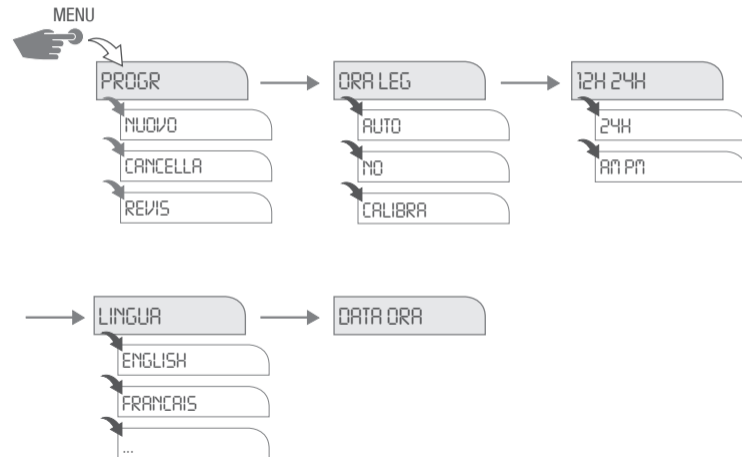



## Prima messa in funzione – Selezione della lingua del menu

**i** Al momento di consegna, il timer è in funzionamento automatico con preimpostazione dell'ora, della data (CET) e della lingua inglese. Premere il tasto Menu per realizzare delle impostazioni. Selezionare poi l'impostazione desiderata.

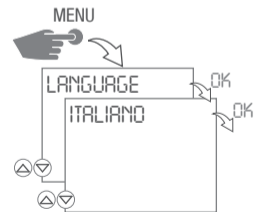

## Impostazione della data e dell'ora

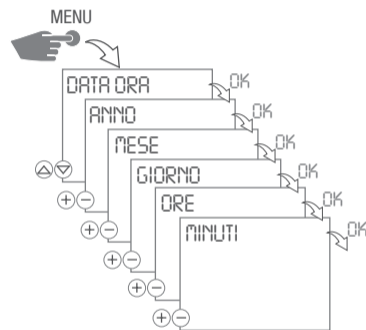

**i** Nel menu **12H 24H** si può scegliere tra l'indicazione AM/PM o di 12/24 ore.



## Cambio ora legale/solare

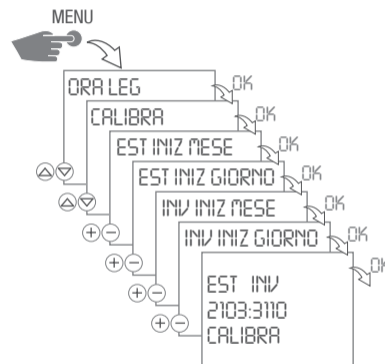

Sono possibili le seguenti impostazioni:

### AUTO

Preimpostazione di fabbrica secondo le disposizioni di legge (CET). Ciò viene ricalcolato ogni anno.

### NO

Nessun cambio.

### CALIBRA

Programmazione manuale. La preimpostazione di fabbrica viene sovrascritta. L'ora legale/solare programmata viene ricalcolata automaticamente per ogni anno. L'ora viene cambiata nello stesso giorno della settimana impostato della stessa settimana del mese.



## Generazione del programma

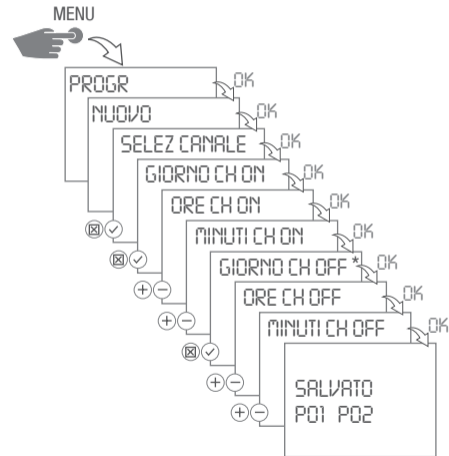

\*) È disponibile solo se i giorni singoli sono stati selezionati per il comando ON.



1. Premere il tasto Menu.
2. Confermare **PROGR** con **OK**.
3. Confermare **NUOVO** con **OK**.
  - ▷ Le posizioni di memoria libere vengono visualizzate brevemente.
4. Solo per la versione a 2 canali:  
Selezionare il canale  e confermare con **✓**.  
→ **OK**
  - ▷ L'indicazione per il giorno della settimana lampeggia.

Comando ON:

5. Selezionare i giorni desiderati  e confermare con **✓**. → **OK**
6. Immettere l'ora (+/-) → **OK**
7. Immettere i minuti (+/-) → **OK**

Comando OFF:

8. Se richiesto, selezionare i giorni desiderati  e confermare con **✓**. → **OK**
9. Immettere l'ora (+/-) → **OK**
10. Immettere i minuti (+/-) → **OK**
  - ▷ Il programma viene memorizzato.



## Visualizzazione e modifica del programma

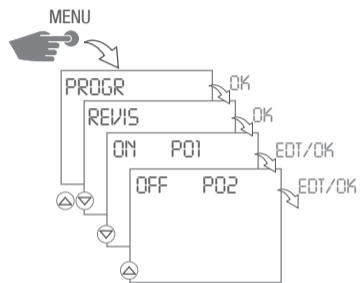

- Con  $\triangle$   $\nabla$  si può scorrere nei passi del programma.
- Premere **OK** per passare al prossimo programma.
- Premere **EDT** per modificare il programma in questione.  
La procedura corrisponde alla generazione di un programma nuovo.



## Cancellazione di programmi

### Cancellare tutti i programmi

- Premere **SI** per cancellare tutti i programmi.
- Premere **NO** per cancellare singoli programmi.

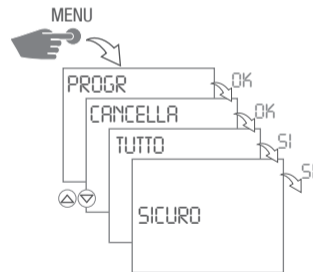

### Cancellare singoli i programmi

- Se vengono cancellati singoli programmi, vengono cancellati tutti i passi di programma corrispondenti (ad es. P01 ON e P02 OFF).
- Premere **OK** per passare al prossimo programma.

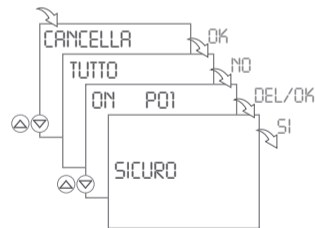





## Funzionamento manuale/automatico

- Interruttore manuale: durata ON / durata OFF / funzionamento automatico
- Tasto a sinistra = canale 1 / tasto a destra = canale 2

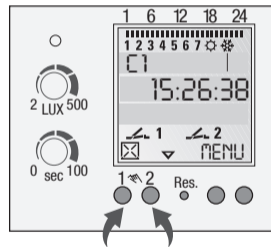

- Premere una volta = FIX ON = durata ON
- Premere due volte = FIX OFF = durata OFF
- Premere 3 volte = funzionamento automatico

## Indicazione dello stato di attivazione

— 1 = canale ON

↘ 1 = canale OFF

Non vi è nessuna visualizzazione nel modo automatico



## Smaltimento / Riciclaggio

Il materiale d'imballaggio va eliminato correttamente in conformità alle disposizioni e normative di legge.

Per lo smaltimento di componenti del sistema guasti o del sistema stesso dopo la durata utile del prodotto vanno rispettate le seguenti indicazioni:

- eliminare correttamente, cioè separando i gruppi di materiale dei pezzi da smaltire.
- Non gettare i rifiuti elettrici ed elettronici nell'immondizia. Portare queste parti in centri di riciclaggio.
- Smaltire generalmente nel rispetto dell'ambiente in conformità allo stato della protezione dell'ambiente, del riciclaggio e dello smaltimento.



## Índice



**Instrucciones de seguridad ..... 84**



**Detalles del aparato..... 85**

Descripción del aparato .....85

Utilización conforme a las especificaciones.....85

Datos técnicos.....86



**Instalación y montaje..... 87**

Montaje en carril DIN .....87

Conexión y montaje del sensor de luminosidad .....87

Esquema de conexión.....88

Puesta en marcha.....89



**Manejo y ajuste ..... 90**

Visualizaciones en la pantalla y teclas de funciones .....90



Estructura del menú .....93

Primera puesta en marcha – Selección del idioma del menú .....94

Ajustar la hora y la fecha .....94

Horario de verano / invierno .....95

Crear programa .....96

Visualizar y editar programa .....98

Borrar programas .....99

Modo automático/manual .....100



**Eliminación / reciclaje ..... 101**



## Instrucciones de seguridad



### ADVERTENCIA

#### ¡Peligro de muerte por electrocución!

▷ ¡La conexión y el montaje deben realizarse por un electricista profesional!

- Respetar las normativas nacionales e instrucciones de seguridad.
- Las manipulaciones y modificaciones en el aparato eximen del derecho de garantía.
- Diámetro mínimo de los cables flexibles para los bornes de conexión: 1 mm<sup>2</sup>  
Diámetro máximo: 4 mm<sup>2</sup>

Leer y observar estas instrucciones de uso para poder garantizar el funcionamiento perfecto del aparato y un manejo seguro.



## Detalles del aparato

### Descripción del aparato

Interruptor crepuscular

- 1 canal o 2 canales
- Retraso de activación/desactivación ajustable: 0-100 seg.
- Pueden utilizarse hasta 10 aparatos (20 canales) para obtener un sistema de regulación de luz utilizando un solo sensor de luminosidad.
- Con temporizador semanal

### Utilización conforme a las especificaciones

- Este interruptor crepuscular se utiliza para
  - Iluminación en el hogar y el comercio
  - Iluminación publicitaria
  - Alumbrado público
  - Iluminación de escaparates
  - Iluminación de aparcamientos
  - Activación de persianas
- Montaje sólo en carril DIN.
- ¡Únicamente para lugares secos!



## Datos técnicos

### Potencia de ruptura:

- Carga óhmica (VDE, IEC) 16 A / 250 V AC
- Carga inductiva  $\cos \varphi 0,6$  10 A / 250 V AC
- Carga de lámpara incandescente/lámpara de halógeno 2600 W
- Lámpara fluorescente 1000 W
- Potencia de ruptura máx. AC1 / AC15 3700 W / 750 W

### Temperatura ambiental:

- Regulador / sensor de luminosidad -10°C... + 55°C / -30°C ... + 70°C

### Grado de protección:

- Regulador / sensor de luminosidad IP 20 / IP 65

### Interruptor crepuscular:

- Rango de ajuste 2-500 lx
- Retraso de activación ajustable: aprox. 0-100 seg. CON / 0-100 seg. DES

### Temporizador:

- Espacios de memoria 50
- Precisión de marcha típ.  $\pm 1$  seg./día a +20°C
- Reserva de cuerda 3 años desde la fábrica



## Instalación y montaje



**ADVERTENCIA**

**¡Peligro de muerte por electrocución!**

▷ ¡La conexión y el montaje deben realizarse por un electricista profesional!

### Montaje en carril DIN

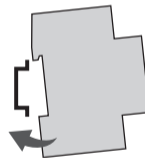

Colocar el aparato ligeramente inclinado por encima del carril. Después empujarlo hacia atrás hasta que enganche.

### Conexión y montaje del sensor de luminosidad

1



2

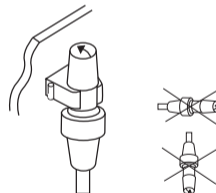

- Longitud del cable de conexión: máx. 100 m
- Sección transversal del cable: mín. 2 x 0,75 mm<sup>2</sup>



## Esquema de conexión

- ⚠ Después de conectar el sensor a los bornes + y - debe montarse un jumper entre los bornes B1 y B2.
- Si se utilizan varios aparatos con un solo sensor, este jumper debe montarse sólo en un aparato.

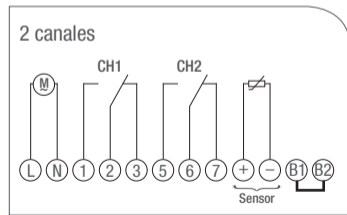
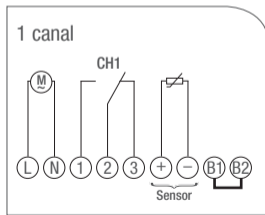

## Puesta en marcha

- ⚠ Después de conectar el sensor a los bornes + y - debe montarse un jumper entre los bornes B1 y B2.
- Si se utilizan varios aparatos con un solo sensor, este jumper debe montarse sólo en un aparato.

El aparato - interruptor crepuscular y temporizador - activa la salida (bornes 1 y 5) únicamente si las 3 condiciones están cumplidas:

- no se alcanza el valor de luminosidad ajustado
- el tiempo de retraso ajustado ha vencido
- el temporizador está en = conectado

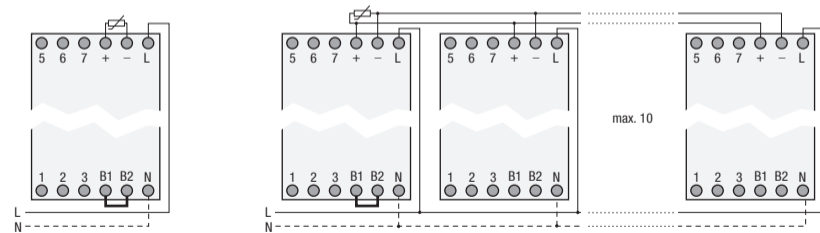



## Manejo y ajuste

### Visualizaciones en la pantalla y teclas de funciones

- La línea central de la pantalla, con los valores ajustados y los puntos de menú seleccionados, se visualiza en grande.
- Una entrada es necesaria si parpadea. Si no se realiza ninguna entrada dentro de dos minutos, el reloj vuelve al modo automático.
- Todos los programas se mantienen si se realiza un reset del aparato; sólo hay que reajustar fecha y hora. Pulsar el botón Reset mediante un objeto desafilado (bolígrafo).



### Ajuste del valor de lux

Ajustar el valor de lux deseado mediante el botón de ajuste (2-500 lx).

- ▷ El LED se enciende en cuanto la luminosidad del ambiente es inferior al valor de lux ajustado.

### Ajuste del tiempo de retraso

Ajustar el tiempo de retraso deseado mediante el botón de ajuste (0-100 seg.).

- ▷ De este modo se evitan las activaciones erróneas por causa de breves efectos luminosos, p. ej. rayos.

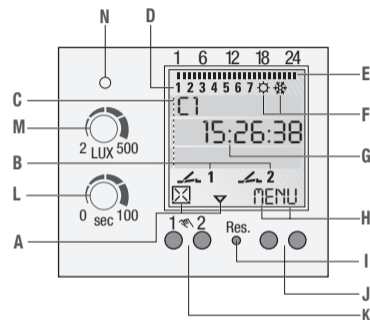

### Pantalla

- A Funciones de los dos botones a la izquierda
- B Indicación del estado
- C 3 líneas de la pantalla
- D Día de la semana
- E Vista general del programa de activación diaria
- F Horario de verano/invierno
- G Tensión de servicio (puntos permanentes)  
Modo de reserva de cuerda (puntos parpadean)
- H Funciones de los dos botones a la derecha

### Teclas/botones

- I Reset
- J Botones a la derecha
- K Botones a la izquierda para activación manual en modo automático
- L Botón de ajuste del retraso de activación
- M Botón de ajuste del valor de lux
- N Indicación del estado sin retraso



### Funciones de los dos botones a la izquierda:

- △ Desplazar hacia arriba en el menú
- ▽ Desplazar hacia abajo en el menú
- ☒ Descartar selección
- ✓ Confirmar selección
- + Pulsar brevemente = +1 / Mantener pulsado (aprox. 2 seg.) = +5
- Pulsar brevemente = -1 / Mantener pulsado (aprox. 2 seg.) = -5

### Funciones de los dos botones a la derecha:

- MENU** Terminar el modo automático e iniciar el modo de programación
- ESC** Pulsar brevemente = un paso atrás  
Mantener pulsado (aprox. 2 seg.) = Volver al modo automático
- OK** Seleccionar y confirmar la selección
- EDT** Modificar los programas en modo de lectura
- NO** No ejecutar comando
- SI** Ejecutar comando
- DEL** Borrar



### Estructura del menú

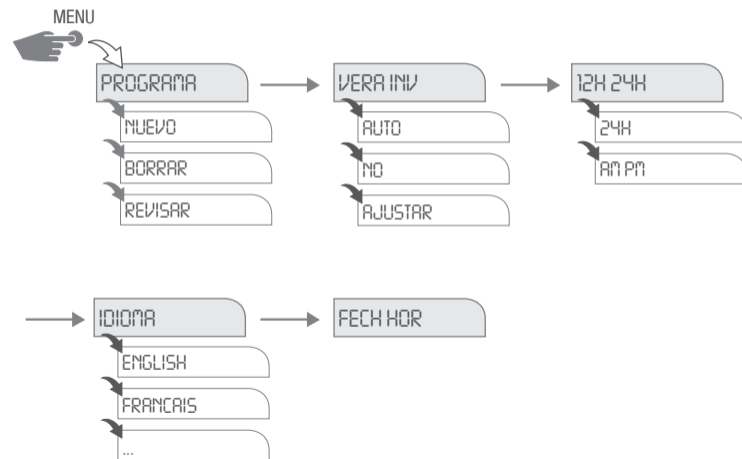



## Primera puesta en marcha – Selección del idioma del menú



Al entregar el temporizador está ajustado el modo automático con hora (CET) y fecha preajustadas y el menú en inglés. Pulsar el botón de menú para realizar ajustes. Después seleccionar el ajuste deseado.

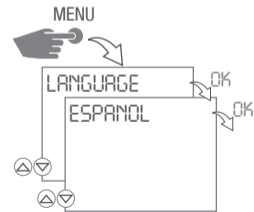

## Ajustar la hora y la fecha

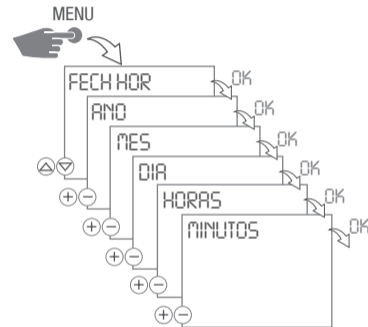

En el menú **12H 24H** puede seleccionarse entre la visualización AM/PM y la visualización de 12/24 horas.



## Horario de verano / invierno

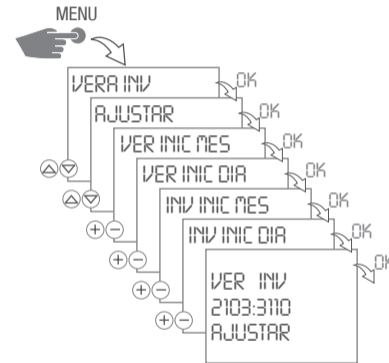

Los siguientes ajustes son posibles:

### AUTO

Preajuste de fábrica según la disposición legal (CET). Se calcula cada año de nuevo.

### NO

Ningún cambio.

### AJUSTAR

Programación manual. Se modifica el preajuste de fábrica. El horario de verano/invierno programado se vuelve a calcular automáticamente cada año. La conmutación siempre se realiza el mismo día de la semana de la misma semana del mes.





## Crear programa

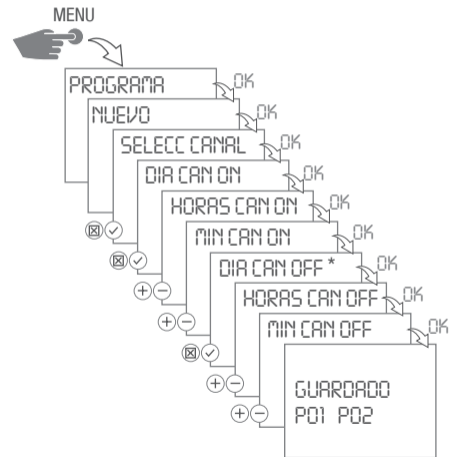

\*) Sólo está disponible después de haber seleccionado días individuales en el comando CON.



1. Pulsar el botón de menú.
2. Confirmar el **PROGRAMA** pulsando **OK**.
3. Confirmar **NUEVO** pulsando **OK**.
  - ▷ Los espacios de memoria libres se visualizan brevemente.
4. Sólo con versión de dos canales:  
 Seleccionar el canal  y confirmar pulsando **✓ . → OK**
  - ▷ La visualización del día de la semana parpadea.

### Comando CON:

5. Seleccionar los días deseados  y confirmar pulsando **✓ . → OK**
6. Introducir la hora (+/-) → **OK**
7. Introducir los minutos (+/-) → **OK**

### Comando DES:

8. Si aparece el mensaje, seleccionar los días deseados  y confirmar pulsando **✓ . → OK**
9. Introducir la hora (+/-) → **OK**
10. Introducir los minutos (+/-) → **OK**
  - ▷ Se guarda el programa.



## Visualizar y editar programa

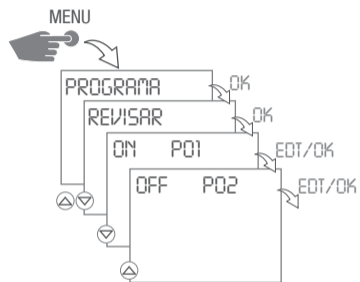

- Pulsar  $\triangle$   $\nabla$  para hojear los pasos del programa.
- Pulsar **OK** para abrir el siguiente programa.
- Pulsar **EDT** para modificar el programa activo.  
El procedimiento es idéntico a la creación de un nuevo programa.



## Borrar programas

### Borrar todos los programas

- Pulsar **SI** para borrar todos los programas.
- Pulsar **NO** para borrar programas individuales.

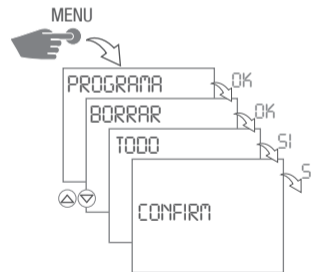

### Borrar programas individuales

- Si se borran programas individuales, se borran también todos los pasos del programa (p. ej. ON P01 y OFF P02).
- Pulsar **OK** para abrir el siguiente programa.

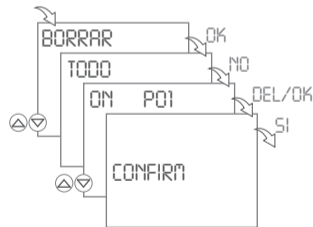



## Modo automático/manual

- Botón manual: FIX ON / FIX OFF / Modo automático
- Botón izquierdo = Canal 1 / Botón derecho = Canal 2

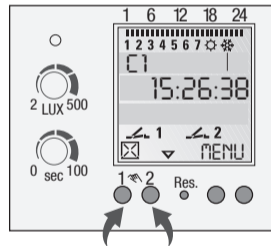

- Pulsar 1x = FIX ON = conexión permanente
- Pulsar 2x = FIX OFF = desconexión permanente
- Pulsar 3x = modo automático

## Indicación del estado

— 1 = Canal activado

↘ 1 = Canal desactivado

No hay ninguna visualización en modo automático.



## Eliminación / reciclaje





El material de embalaje debe eliminarse adecuadamente conforme a las disposiciones y normativas legales.

Tener en cuenta las siguientes indicaciones relativas a la eliminación de componentes defectuosos o del sistema después de su vida útil:

- Eliminar adecuadamente, es decir separar las piezas a eliminar según los grupos de material.
- No echar los componentes eléctricos o electrónicos a la basura. Llevarlos a los puntos de recogida correspondientes.
- Desechar los componentes generalmente acorde con el medio ambiente conforme al estado actual de las técnicas de protección del medio ambiente, de reciclaje y de eliminación.



## Índice

	<b>Indicações de segurança.....</b>	<b>104</b>
	<b>Indicações referentes ao aparelho .....</b>	<b>105</b>
	Descrição do aparelho .....	105
	Utilização prevista.....	105
	Dados técnicos .....	106
	<b>Instalação e montagem .....</b>	<b>107</b>
	Montagem sobre trilho DIN .....	107
	Ligação e montagem do sensor de luminosidade.....	107
	Esquema de ligação.....	108
	Colocação em funcionamento.....	109
	<b>Operação e ajuste.....</b>	<b>110</b>
	Visualização no ecrã e teclas de função .....	110



	<b>Eliminação de resíduos / reciclagem.....</b>	<b>121</b>
-------------------------------------------------------------------------------------	-------------------------------------------------	------------

Menüstruktur .....	113
Primeira colocação em funcionamento – Selecção da língua do menu.....	114
Ajustar data e hora .....	114
Mudar para horário de verão / inverno .....	115
Criar programa .....	116
Visualizar e editar programa .....	118
Apagar programas.....	119
Modo automático / manual .....	120



## Indicações de segurança



**PERIGO**

### Perigo de morte por choque eléctrico!

- ▷ A ligação e a montagem devem ser executadas exclusivamente por um electricista qualificado!

- Observar as prescrições e instruções de segurança nacionais em vigor.
- Qualquer intervenção ou modificação no aparelho acarreta na perda da garantia.
- Diâmetro mínimo dos cabos flexíveis para os bornes de ligação: 1mm<sup>2</sup>.  
Diâmetro máximo: 4mm<sup>2</sup>

Ler e observar este manual para garantir um funcionamento correcto do aparelho e um trabalho seguro.



## Indicações referentes ao aparelho

### Descrição do aparelho

Interruptor crepuscular

- 1 canal ou 2 canal
- Activação e desactivação do temporizador regulável: 0 – 100 s.
- Até 10 aparelhos (20 canais) podem criar um sistema de comando de iluminação com um único sensor de luminosidade.
- Com temporizador semanal

### Utilização prevista

- O interruptor crepuscular se utiliza para
  - Iluminação na área privada e comercial
  - Iluminação publicitária
  - Iluminação pública
  - Iluminação de vitrinas
  - Iluminação de estacionamentos
  - Comando de persianas
- Montagem somente sobre trilho DIN.
- Usar exclusivamente em locais secos!



## Dados técnicos

Capacidade de ruptura:

- Carga óhmica (VDE, IEC)
- Carga indutiva cos  $\phi$  0,6
- Carga da lâmpada incandescente/lâmpada de halogénio
- Lâmpada fluorescente
- Capacidade de ruptura máx. AC1 / AC15

16 A / 250 V AC  
 10 A / 250 V AC  
 2600W  
 1000W  
 3700W / 750W

Temperatura ambiente:

- Controlador / sensor de luminosidade

-10°C ... + 55°C / -30°C ... + 70°C

Tipo de protecção:

- Controlador / sensor de luminosidade

IP 20 / IP 65

Interruptor crepuscular:

- Faixa de ajuste
- Retardo de activação

2 lx – 500 lx  
 ajustável: aprox. 0-100 s ON/0-100 s OFF

Temporizador:

- Espaços de memória
- Precisão de marcha
- Reserva de marcha

50  
 tipo  $\pm$  1 s/dia a +20°C  
 3 anos desde fábrica



## Instalação e montagem



PERIGO

**Perigo de morte por choque eléctrico!**

- ▷ A ligação e a montagem devem ser executadas exclusivamente por um electricista qualificado!

### Montagem sobre trilho DIN

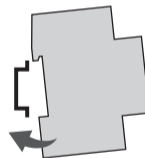

Colocar o aparelho ligeiramente inclinado em cima do trilho. Depois empurrá-lo para trás até que enganche.

### Ligação e montagem do sensor de luminosidade

1



2

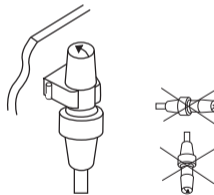

- Comprimento do cabo de ligação: max. 100 m
- Secção transversal do cabo: mín. 2 x 0,75 mm<sup>2</sup>



## Esquema de ligação



Depois de ligar o sensor aos bornes + e - se deve estabelecer uma ponte entre os bornes B1 e B2.

Se vários aparelhos funcionam com um sensor, a ponte deve ser estabelecida somente em um aparelho.

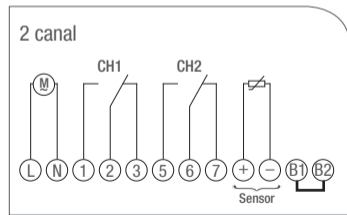
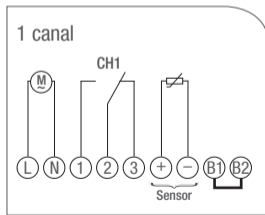

## Colocação em funcionamento



Depois de ligar o sensor aos bornes + e - se deve estabelecer uma ponte entre os bornes B1 e B2.

Se vários aparelhos funcionam com um sensor, a ponte deve ser estabelecida somente em um aparelho.

O aparelho – interruptor crepuscular e temporizador - activa a saída (borne 1 e 5) somente se as 3 condições seguintes forem dadas:

- não é atingido o valor de luminosidade ajustado
- o tempo de retardo ajustado decorreu
- o temporizador está posicionado em = ON

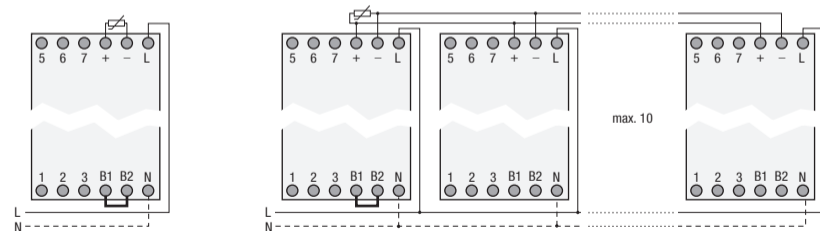



## Operação e ajuste

### Visualização no ecrã e teclas de função

- A linha central do ecrã que mostra os valores de ajuste e os pontos de menu para selecção, se visualiza em formato grande.
- Intermitente significa uma entrada necessária. Se não for efectuada nenhuma entrada dentro de dois minutos, o temporizador retorna ao modo automático.
- No caso de repor a zero, os programas permanecem conservados. Data e hora devem ser reajustados. Apertar a tecla Reset com um objecto não afiado (caneta).

### Ajuste do valor Lux

Ajustar o botão de ajuste ao valor Lux desejado (2- 500 Lux).

- ▷ LED se ilumina quando a luminosidade do ambiente for inferior ao valor Lux ajustado.

### Ajuste do tempo de retardo

Ajustar o tempo de retardo desejado no botão de ajuste (0 - 100 s).

- ▷ Deste modo se evita activações falsas causadas por breves influências luminosas externas, por ex. relâmpagos, etc.

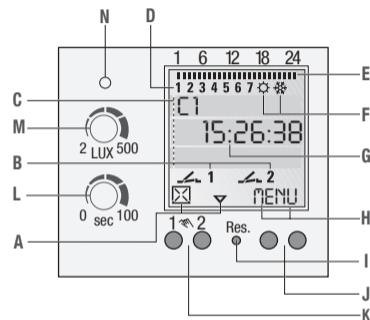

### Ecrã

- A** Funções das duas teclas a esquerda
- B** Indicação do estado
- C** 3 linhas do ecrã
- D** Dia da semana
- E** Visão geral do programa de activação diário
- F** Horário de verão / inverno
- G** Tensão de serviço (pontos permanentes)  
Modo reserva de marcha (pontos intermitentes)
- H** Função das duas teclas a direita

### Teclas/botões

- I** Reset
- J** Teclas a direita
- K** Teclas a esquerda para activação do modo manual no modo automático
- L** Botão de ajuste do retardo de activação ON/OFF
- M** Botão de ajuste do valor Lux
- N** Indicação do estado sem retardo





### Funções das duas teclas a esquerda:

- △ deslocar para cima no menu
- ▽ deslocar para baixo no menu
- ☒ Rejeitar selecção
- ✓ Aceitar selecção
- + Premir brevemente = +1 / premir longamente (aprox. 2 s) = +5
- Premir brevemente = -1 / premir longamente (aprox. 2 s) = -5

### Funções das duas teclas a direita:

- MENU** Sair do modo automático e entrar no modo de programação
- ESC** Premir brevemente = um passo para trás  
Premir longamente (aprox. 2 s) = retorno ao modo automático
- OK** Seleccionar e aceitar
- EDT** Modificar programas no "modo de leitura"
- NA** Não executar o comando
- SIM** Executar o comando
- DEL** Apagar



### Menüstruktur

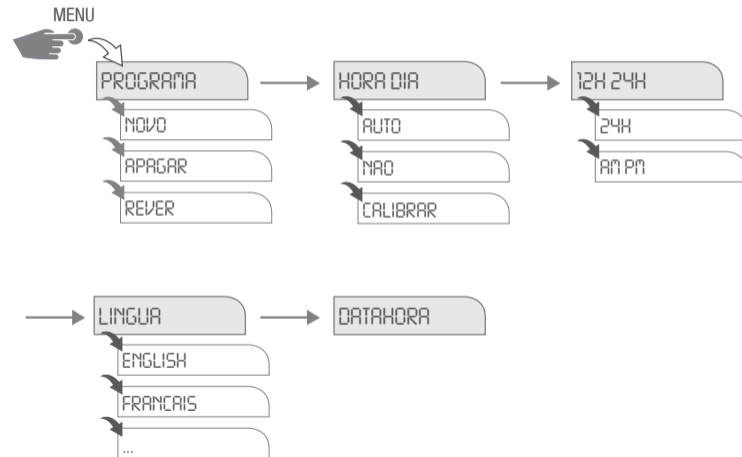



## Primeira colocação em funcionamento – Seleção da língua do menu

**i** Na entrega, o temporizador está no modo automático com pré-ajuste da hora, data (Hora Central Europeia) e da língua inglesa. Premir a tecla menu para executar ajustes. Depois seleccionar o ajuste desejado.

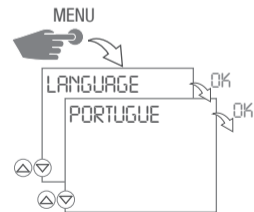

## Ajustar data e hora

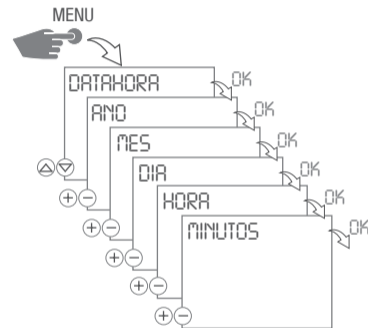

**i** No menu 12H 24H se pode seleccionar entre a visualização AM/PM e a visualização de 12/24 horas.



## Mudar para horário de verão / inverno

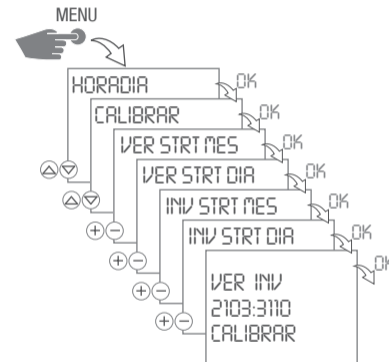

Os seguintes ajustes são possíveis:

### AUTO

Pré-ajuste de fábrica segundo as disposições em vigor (HCE). Se calcula cada ano de novo.

### NÃO

Sem mudança.

### CALIBRAR

Programação manual. O pré-ajuste de fábrica é sobrescrito. O horário de verão / inverno programado se recalcula automaticamente a cada ano. A mudança ocorre no mesmo dia da semana entrado dentro da mesma semana do mês.



## Criar programa

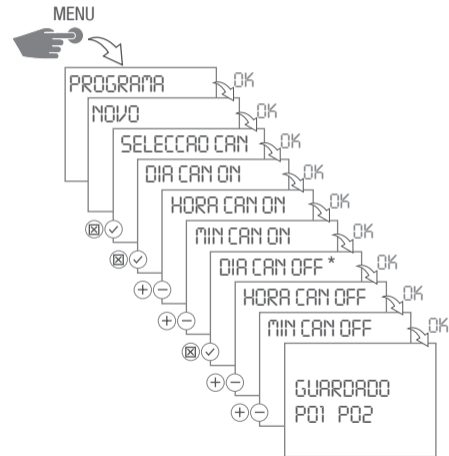

\*) Somente está disponível depois de ter seleccionado dias individuais no comando ON.



1. Premir a tecla menu.
2. Confirmar o **PROGRAMA** com **OK**.
3. Confirmar **NOVO** com **OK**.
  - ▷ Os espaços de memória livre são visualizados brevemente.
4. Somente na versão de 2 canais:
  - Seleccionar canal  e aceitar com **✓** . → **OK**
  - ▷ Indicador dos dias de semana pisca.

### Comando ON:

5. Seleccionar os dias desejados  e confirmar com **✓** . → **OK**
6. Entrar a hora (+/-) → **OK**
7. Entrar os minutos (+/-) → **OK**

### Comando OFF:

8. Se requerido, seleccionar os dias desejados  e confirmar com **✓** . → **OK**
9. Entrar a hora (+/-) → **OK**
10. Entrar os minutos (+/-) → **OK**
  - ▷ O programa é guardado.



## Visualizar e editar programa

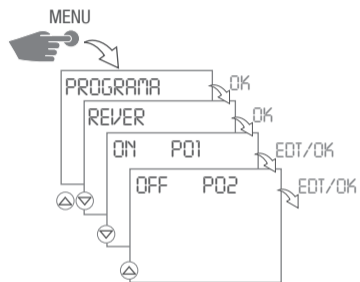

- Com  $\triangle$   $\nabla$  se pode folhar nos passos do programa.
- Premir **OK** para aceder ao próximo programa.
- Premir **EDT** para editar o respectivo programa.  
O procedimento corresponde a criação de um novo programa.



## Apagar programas

### Apagar todos os programas

- Premir **SIM** para apagar todos os programas.
- Premir **NA** para apagar programas individuais.

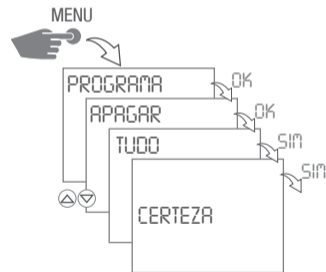

### Apagar programas individuais

- Ao apagar programas individuais são apagados também todos os passos do programa correspondente (por ex. P01 ON e P02 OFF).
- Premir **OK** para aceder ao próximo programa.

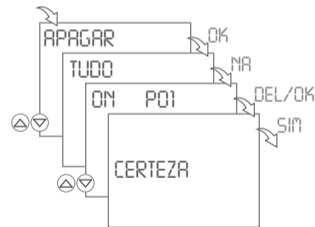



## Modo automático / manual

- Interruptor manual: Duração ON / duração OFF / modo automático
- Tecla esquerda = canal 1 / tecla direita = canal 2

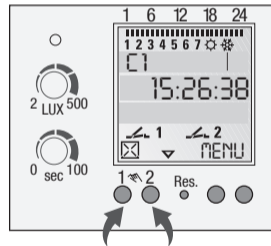

- Premir 1 vez = FIX ON = duração ON
- Premir 2 vezes = FIX OFF = duração OFF
- Premir 3 vezes = modo automático

## Indicação do estado

— 1 = canal ON

↘ 1 = canal OFF

Não ocorre nenhuma visualização no modo automático.



## Eliminação de resíduos / reciclagem

O material de embalagem deve ser eliminado correctamente segundo as disposições e regulamentações legais.

Para a eliminação dos componentes do sistema defeituosos ou do sistema depois da sua vida útil devem ser observadas as seguintes indicações:

- Elimine os resíduos correctamente, ou seja, separando as peças segundo o grupo de material.
- Não jogue sucata eléctrica ou electrónica no lixo. Entregue estas peças nos respectivos centros de recepção.
- Elimine em geral os resíduos segundo o estado actual da técnica de protecção do meio ambiente, de reciclagem e de eliminação de resíduos.



## Inhoudsopgave



### Veiligheidsaanwijzingen ..... 124



### Gegevens van het apparaat ..... 125

Beschrijving apparaat ..... 125

Gebruik volgens de voorschriften ..... 125

Technische gegevens ..... 126



### Installatie en montage ..... 127

Montage op DIN-rail ..... 127

Aansluiting en montage van de lichtsensor ..... 127

Aansluitschema ..... 128

Inbedrijfstelling ..... 129



### Bediening en instelling ..... 130

Displaybeeld en functietoetsen ..... 130



Menustructuur ..... 133

Eerst inbedrijfstelling – Keuze van de menutaal ..... 134

Datum en tijd instellen ..... 134

Omschakelen zomer-/wintertijd ..... 135

Programma maken ..... 136

Programma bekijken en bewerken ..... 138

Programma's wissen ..... 139

Automatisch/handmatig bedrijf ..... 140



### Verwijdering / recycling ..... 141



## Veiligheidsaanwijzingen



### WAARSCHUWING

#### Levensgevaar door elektrische schok!

▷ Aansluiting en montage uitsluitend door een elektromonteur!

- Neem de nationale voorschriften en veiligheidsvoorwaarden in acht.
- Modificaties en wijzigingen aan het apparaat leiden tot het vervallen van de garantie.
- Minimum diameter van de flexibele kabels voor de aansluitklemmen: 1mm<sup>2</sup>.  
Maximum diameter: 4mm<sup>2</sup>

Lees en neem beslist deze handleiding in acht om een onberispelijke werking van het apparaat en een veilig werken te waarborgen.



## Gegevens van het apparaat

### Beschrijving apparaat

Schemerschakelaar

- 1 kanaal of 2 kanaal
- Instelbare AAN-/UIT-schakel-vertraging:  
0 – 100 sec.
- Er kan uit maximaal 10 apparaten (20 kanalen) een lichtbesturingssysteem met slecht één lichtsensor worden samengesteld.
- Met wekschakelklok

### Gebruik volgens de voorschriften

- De schemerschakelaar wordt gebruikt voor
  - verlichtingen op particulier en zakelijk gebied
  - reclameverlichting
  - straatverlichting
  - etalageverlichting
  - parkeerplaatsverlichting
  - besturing van rolluiken en jaloezieën
- Montage alleen op DIN-rail.
- Alleen geschikt voor gebruik in droge ruimtes!



## Technische gegevens

### Schakelvermogen:

– ohmse belasting (VDE, IEC)	16 A / 250 V AC
– inductieve belasting $\cos \varphi$ 0,6	10 A / 250 V AC
– gloei-/halogeenlampbelasting	2600W
– fluorescentielamp	1000W
– max. schakelvermogen AC1 / AC15	3700W / 750W

### Omgevingstemperatuur:

– stuurapparaat / lichtsensor	-10°C ... + 55°C / -30°C ... + 70°C
-------------------------------	-------------------------------------

### Beschermingsklasse:

– stuurapparaat / lichtsensor	IP 20 / IP 65
-------------------------------	---------------

### Schemerschakelaar:

– instelbereik	2 lx – 500 lx
– schakelvertraging	instelbaar: ca. 0-100 s AAN/0-100 s UIT

### Schakelklok:

– geheugens	50
– gangnauwkeurigheid	typ $\pm 1$ s/dag bij +20°C
– gangreserve	3 jaar af fabriek



## Installatie en montage



**WAARSCHUWING**

**Levensgevaar door elektrische schok!**

▷ Aansluiting en montage uitsluitend door een elektromonteur!

### Montage op DIN-rail

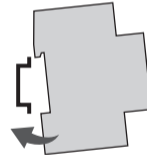

Apparaat iets schuin, van boven op de rail zetten. Vervolgens naar achteren drukken, tot hij vastklikt.

### Aansluiting en montage van de lichtsensor

1



2

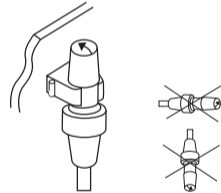

- Lengte van de aansluitkabel: max. 100 m
- Kabeldiameter: min. 2 x 0,75 mm<sup>2</sup>





## Aansluitschema

- ⚠ Bij de aansluiting van de sensor op de klemmen + en – moet u ook tussen de klemmen B1 en B2 een brug maken. Wanneer u meerdere apparaten met één sensor gebruikt, mag deze brug slechts op één apparaat gemaakt worden.

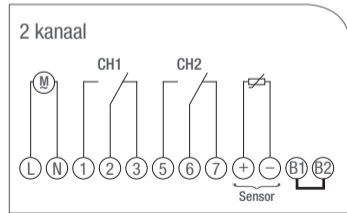
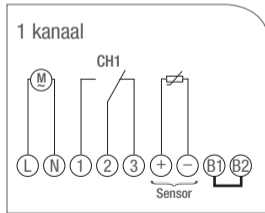

## Inbedrijfstelling

- ⚠ Bij de aansluiting van de sensor op de klemmen + en – moet u ook tussen de klemmen B1 en B2 een brug maken. Wanneer u meerdere apparaten met één sensor gebruikt, mag deze brug slechts op één apparaat gemaakt worden.

Het apparaat – schemerschakelaar en schakelklok, schakelt de uitgang (klem 1 en 5) alleen actief, wanneer aan alle 3 voorwaarden voldaan is:

- de instelde lichtwaarde is onderschreden
- de ingestelde vertragingstijd is afgelopen
- de schakelklok staat op = AAN

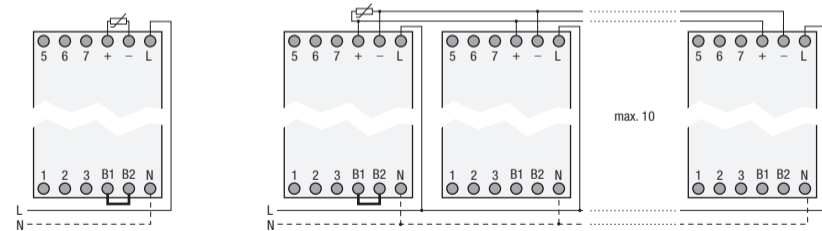



## Bediening en instelling

### Displaybeeld en functietoetsen

- De middelste regel van de display, die de in te stellen waarden en te kiezen menupunten toont, wordt groot aangegeven.
- Knipperen markeert een noodzakelijke invoer. Geschiedt binnen twee minuten geen invoer, keert de klok terug naar automatisch bedrijf.
- Bij een reset blijven de programma's behouden. Datum en tijd moet u opnieuw instellen. Reset-knop met een stomp voorwerp (pen) drukken.

### Instelling van de luxwaarde

Instelknop op de gewenste lux-waarde (2- 500 lux) zetten.

- ▷ LED brandt, zodra de ingestelde lux-waarde het omgevingslicht onderschrijft.

### Instelling van de vertragingstijd

Instelknop op de gewenste vertragingstijd (0 - 100 sec) instellen.

- ▷ Reductie van verkeerde schakelingen door kortstondige uitwendige lichtinvloeden zoals bliksem etc.

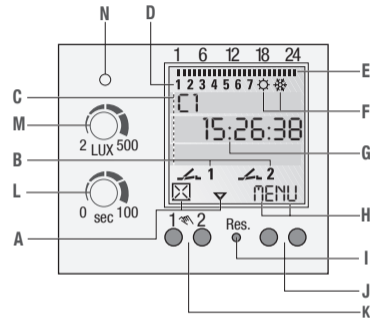

### Display

- A Functie-indicaties van de beide linker toetsen
- B Schakeltoestandindicaties
- C 3 display-regels
- D Weekdagindicatie
- E Overzicht dagschakelprogramma
- F Indicatie zomer-/wintertijd
- G Bedrijfsspanning (permanente punten)  
Gangreservebedrijf (punten knipperen)
- H Functie-indicaties van de beide rechter toetsen

### Toetsen/schakelaars

- I Reset
- J Rechter toetsen
- K Linker toetsen met handschakelaarfunctie bij automatisch bedrijf
- L Instelknop AAN-/UIT-schakelvertraging
- M Instelknop luxwaarde
- N Schakeltoestandindicatie onvertraagd



### Funcie-indicaties van de beide linker toetsen:

- △ in het menu naar boven bladeren
- ▽ in het menu naar beneden bladeren
- ☒ keuze verwerpen
- ✓ keuze accepteren
- + kort drukken = +1 / lang drukken (ca. 2 sec) = +5
- kort drukken = -1 / lang drukken (ca. 2 sec) = -5

### Funcie-indicaties van de beide rechter toetsen:

- MENU** Verlaten van het automatisch bedrijf en omschakeling naar de programmeermodus
- ESC** Kort drukken = één stap terug  
Lang drukken (ca. 2 sec) = terug naar automatisch bedrijf
- OK** Keuze treffen en accepteren
- EDT** Wijzigen van de programma's in „Lezen-modus“
- NO** Commando niet uitvoeren
- JA** Commando uitvoeren
- DEL** Wissen



### Menustructuur

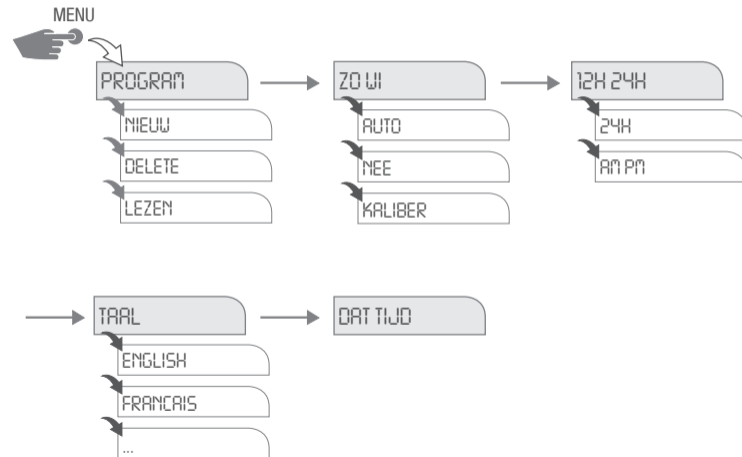



## Eerst inbedrijfstelling – Keuze van de menutaal

**i** In de afleveringstoestand bevindt de verdelerschakelklok zich op automatisch bedrijf met voorinstelde tijd, datum (MET) en Engelse menutaal. Om instellingen uit te voeren drukt u de menutoets. Vervolgens de gewenste instelling kiezen.

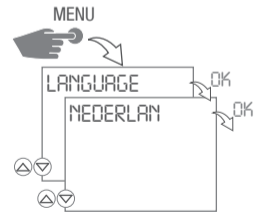

## Datum en tijd instellen

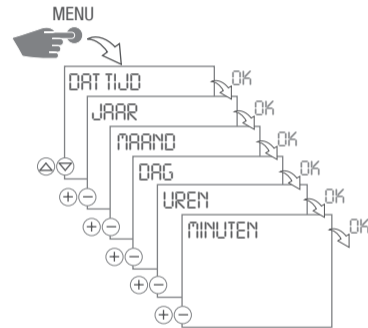

**i** In het menu **12H 24H** kunt u tussen AM/PM en de 12/24-uur-weergave kiezen.



## Omschakelen zomer-/wintertijd

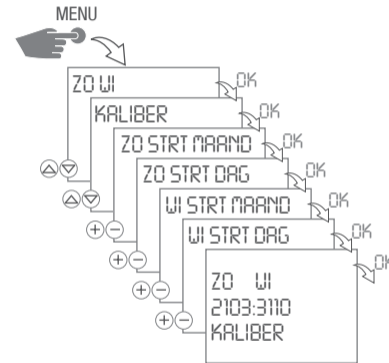

De volgende instellingen zijn mogelijk:

### **AUTO**

Voorinstelling van fabriekswege van de wettelijke vastlegging (MET). Deze wordt ieder jaar opnieuw berekend.

### **NEE**

Geen omstelling.

### **KALIBER**

Handmatige programmering. De voorinstelling van fabriekswege wordt overschreven. De geprogrammeerde zomer-/wintertijd wordt automatisch voor ieder jaar opnieuw berekend. De omschakeling geschiedt op dezelfde ingevoerde weekdag in dezelfde week van de maand.



## Programma maken

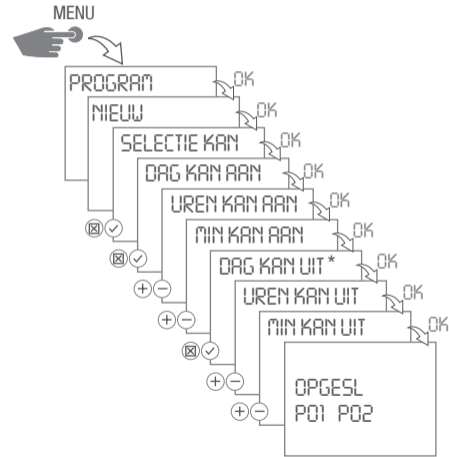

\*) Staat alleen ter beschikking, wanneer bij AAN-commando losse dagen gekozen worden.



1. Menu-toets drukken.
2. **PROGRAMMA** met **OK** bevestigen.
3. **NIEUW** met **OK** bevestigen.
  - ▷ De vrije geheugenplaatsen worden kort aangegeven.
4. Alleen bij 2-kanaal-versie: kanaal kiezen  en met  bevestigen. → **OK**
  - ▷ Indicatie voor weekdays knippert.

### AAN-commando:

5. Gewenste dagen kiezen  en met  bevestigen. → **OK**
6. Uur invoeren (+/-) → **OK**
7. Minuut invoeren (+/-) → **OK**

### UIT-commando:

8. Indien gevraagd, gewenste dagen kiezen  en met  bevestigen. → **OK**
9. Uur invoeren (+/-) → **OK**
10. Minuut invoeren (+/-) → **OK**
  - ▷ Het programma wordt opgeslagen.



## Programma bekijken en bewerken

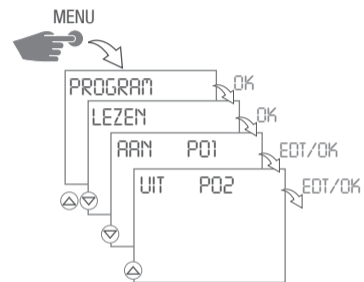

- Met  $\triangle$   $\nabla$  kunt u door de programmastappen bladeren.
- Druk op **OK** om bij het volgende programma te komen.
- Druk op **EDT** om het desbetreffende programma te bewerken. De procedure komt overeen met het maken van een nieuw programma.



## Programma's wissen

### Alle programma's wissen

- Druk op **JA** om alle programma's te wissen.
- Druk op **NO** om losse programma's te wissen.

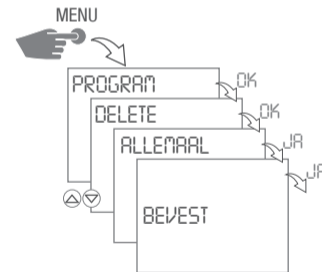

### Losse programma's wissen

- Bij het wissen van losse programma's worden alle bijbehorende programmastappen gewist (bijv. P01 AAN en P02 UIT).
- Druk op **OK** om bij het volgende programma te komen.

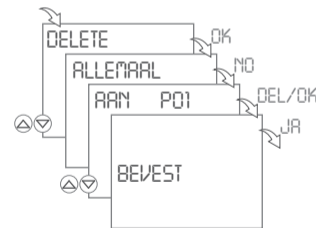



## Automatisch/handmatig bedrijf

- Handschakelaar: permanent AAN / permanent UIT / automatisch bedrijf
- Linker toets = kanaal 1 / rechter toets = kanaal 2

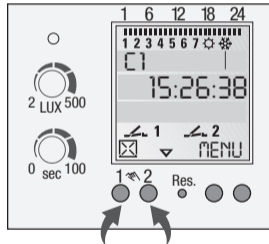

- 1x drukken = FIX ON = permanent AAN
- 2x drukken = FIX OFF = permanent UIT
- 3x drukken = automatisch bedrijf

## Schakeltoestandsindicatie

— 1 = kanaal AAN

— 1 = kanaal UIT

Bij automatisch bedrijf verschijnt geen beeld



## Verwijdering / recycling

Het verpakkingsmateriaal moet volgens de wettelijke bepalingen en verordeningen vakkundig worden verwijderd.

Neem voor de verwijdering van defecte systeemcomponenten of het systeem na de levensduur van het product de volgende aanwijzingen in acht:

- Verwijder vakkundig, d.w.z. gescheiden naar materiaalgroepen van de te verwijderen delen.
- Doe in geen geval elektrisch of elektronisch afval gewoon bij het huisvuil. Gebruik de desbetreffende inleverpunten.
- Verwijder altijd zo milieuvriendelijk als het past met de stand van de milieubescherming, recycling- en verwijderingstechniek.



## Obsah



**Bezpečnostní pokyny ..... 144**



**Specifikace přístroje ..... 145**

Popis přístroje ..... 145

Používání v souladu s určením ..... 145

Technické údaje ..... 146



**Instalace a montáž ..... 147**

Montáž na DIN kolejnici ..... 147

Připojení a montáž světelného čidla ..... 147

Schéma zapojení ..... 148

Uvedení do provozu ..... 149



**Obsluha a nastavení ..... 150**

Displej a funkční klávesy ..... 150



Struktura nabídek ..... 153

První uvedení do provozu – výběr jazyka nabídky ..... 154

Nastavení data a času ..... 154

Přepínání z letního na zimní čas a naopak ..... 155

Vytvoření programu ..... 156

Prohlížení a upravování programu ..... 158

Vymazávání programů ..... 159

Automatický/ruční provoz ..... 160



**Likvidace / recyklace ..... 161**





## Bezpečnostní pokyny



**VÝSTRAHA**

### Smrtelné nebezpečí úderu elektrickým proudem!

- ▶ Připojení a montáž světlé výlučně kvalifikovaným elektrikářům!

- Dodržujte příslušné národní předpisy a podmínky bezpečnosti práce.
- Provedením svévolných zásahů do přístroje či jakýchkoliv úprav přestává platit záruka a končí odpovědnost výrobce za případné škody.
- Minimální průměr pružných vedení připojovacích svorek: 1mm<sup>2</sup>.  
Maximální průměr: 4mm<sup>2</sup>

Tento návod si přečtěte a řiďte se jím, neboť jen tak lze zaručit, že přístroj bude bezvadně fungovat a že práce s ním bude bezpečná.



## Specifikace přístroje

### Popis přístroje

Soumrakový spínač

- 1kanálový nebo 2kanálový
- Nastavitelné zpoždění zapnutí a vypnutí:  
0 – 100 s
- Přístroj je koncipován tak, že je možno vytvořit sestavu řízení osvětlení čítající až 10 přístrojů (20 kanálů) s jedním jediným světelným čidlem.
- S týdenním časovým spínačem

### Používání v souladu s určením

- Soumrakový spínač se používá na
  - osvětlení v soukromém i komerčním sektoru
  - světelnou reklamu
  - pouliční osvětlení
  - osvětlení výloh
  - osvětlení parkovišť
  - ovládání rolet a žaluzií
- Montáž jen na DIN kolejnici.
- Přístroj je vhodný jen do suchých prostorů!



## Technické údaje

### Spínací výkon:

– ohmický odpor (VDE, IEC)	16 A / 250 V AC
– indukční zatížení $\cos \varphi$ 0,6	10 A / 250 V AC
– zatížení žárovek/halogenových zářivek	2600W
– zářivkové svítidlo	1000W
– max. spínací výkon AC1 / AC15	3700W / 750W

### Okolní teplota:

– řídicí jednotka / světelné čidlo	-10°C ... + 55°C / -30°C ... + 70°C
------------------------------------	-------------------------------------

### Druh krytí:

– řídicí jednotka / světelné čidlo	IP 20 / IP 65
------------------------------------	---------------

### Soumrakový spínač:

– rozsah nastavení	2 lx – 500 lx
– zpoždění spínání	nastavitelný rozsah: cca 0-100 s EIN/0-100 s AUS

### Časový spínač:

– paměťová místa	50
– přesnost chodu	typ $\pm 1$ s/den za +20°C
– provozní rezerva	3 roky od expedice ze závodu



## Instalace a montáž



**Smrtelné nebezpečí úderu elektrickým proudem!**

▷ Připojení a montáž světle výlučně kvalifikovaným elektrikářům!

### Montáž na DIN kolejnici

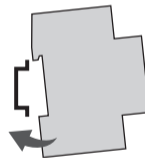

Přístroj nasadte na kolejnici mírně šikmo. Poté jej zatlačte dozadu, aby správně zaklapl.

### Připojení a montáž světelného čidla

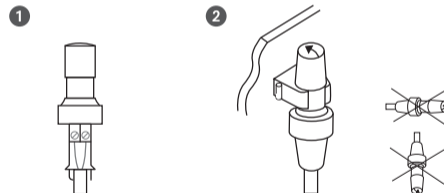

- délka připojovacího kabelu: max. 100 m
- průřez vedení: min. 2 x 0,75 mm<sup>2</sup>



## Schéma zapojení

- ⚠ Připojete-li čidlo ke svorkám + a –, je potřeba, abyste vytvořili můstek také mezi svorkami B1 a B2.  
Pokud k čidlu připojíte přístrojů několik, pak smíte můstek vytvořit jen na jednom z nich.

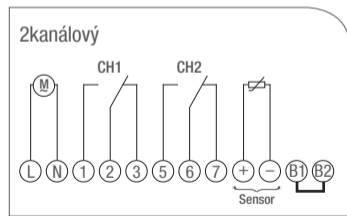
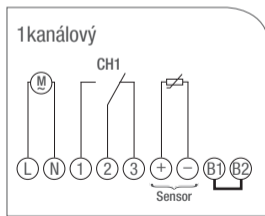

## Uvedení do provozu

- ⚠ Připojete-li čidlo ke svorkám + a –, je potřeba, abyste vytvořili můstek také mezi svorkami B1 a B2.  
Pokud k čidlu připojíte přístrojů několik, pak smíte můstek vytvořit jen na jednom z nich.

Přístroj, tedy soumrakový spínač spolu s časovým spínačem, aktivuje příslušný výstup (na svorkách 1 a 5) jen tehdy, pokud jsou splněny všechny 3 podmínky:

- intenzita světla je slabší než nastavená světelnost
- uplynulo nastavené zpoždění
- časový spínač je  = ZAP

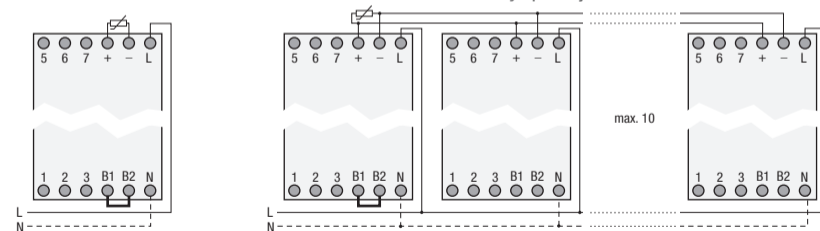



## Obsluha a nastavení

### Displej a funkční klávesy

- Před nastavením potřebných hodnot a výběrem nabídek se zvětší prostřední řádka displeje s možnými hodnotami a dostupnými nabídkami.
- Blikání znamená, že je nutno provést zadání. Pokud k zadání nedojde do dvou minut, vrátí se hodiny zpět do automatického režimu.
- Případné resetování nemá žádný vliv na uložené programy. Je potřeba jen znovu seřadit datum a čas. Na stisknutí tlačítka resetu použijte tupý předmět (propisku).

### Nastavení hodnoty osvětlení

Příslušný knoflík natočte na požadovanou světlost (2- 500 lux).

- ▷ Jakmile nastavená světlost poklesne pod světlost okolí, rozsvítí se LED dioda.

### Nastavení zpoždění

Příslušným knoflíkem nastavte požadovanou délku zpoždění (0 - 100 s).

- ▷ nastavte tak, aby nedocházelo k nechtěnému zapínání vlivem krátkodobých změn světelnosti jako např. blesku atd.

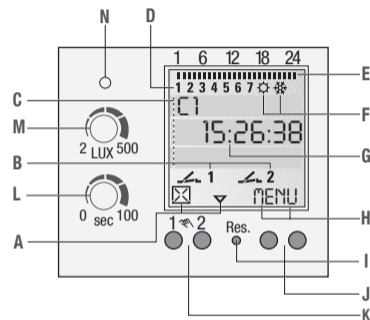

### Displej

- A funkce obou levých tlačítek
- B spínací stav
- C 3 řádky displeje
- D den v týdnu
- E přehled denního spínacího programu
- F letní/zimní čas
- G provozní napětí (body svítí) chod na provozní rezervu (body blikají)
- H funkce obou pravých tlačítek

### Tlačítka/Spínače

- I reset
- J pravá tlačítka
- K levá tlačítka s funkcí ručního přepínání v automatickém režimu
- L knoflík pro nastavení zpoždění ZAP/VYP
- M knoflík pro nastavení osvětlení
- N aktuální spínací stav bez zpoždění



### Funkce obou levých tlačítek:

- △ listovat nabídkou nahoru
- ▽ listovat nabídkou dolů
- ☒ zamítnout výběr
- ✓ potvrdit výběr
- + krátké stisknutí = +1 / dlouhé stisknutí (cca 2 s) = +5
- krátké stisknutí = -1 / dlouhé stisknutí (cca 2 s) = -5

### Funkce obou pravých tlačítek:

- MENU** opuštění automatického režimu a vstup do programovacího režimu
- ESC** krátké stisknutí = o krok zpět  
dlouhé stisknutí (cca 2 s) = zpět do automatického režimu
- OK** provést výběr a potvrdit
- EDT** úpravy programů v „režimu čtení“
- NE** příkaz neprovést
- ANO** příkaz provést
- DEL** výmaz



### Struktura nabídek

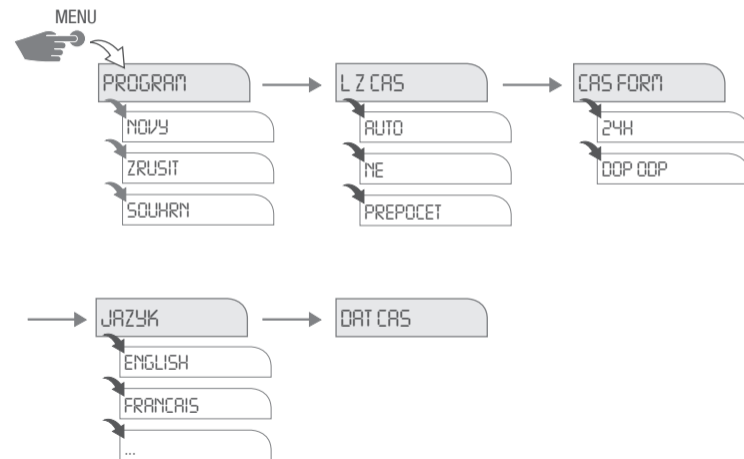



## První uvedení do provozu – výběr jazyka nabídky



Přístroj se dodává ve stavu, kdy je časový spínač v automatickém režimu s přednastaveným časem, datem (SEČ) a angličtinou jako pracovním jazykem. Nastavení změníte tak, že nejprve stisknete tlačítko MENU. A poté vyberete potřebné hodnoty.

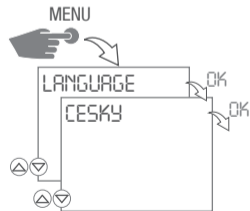

## Nastavení data a času

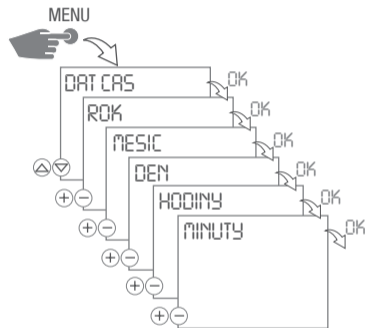

V nabídce 12H 24H máte na výběr ze dvou způsobů zobrazení času, AM/PM a 12/24 hodin.



## Přepínání z letního na zimní čas a naopak

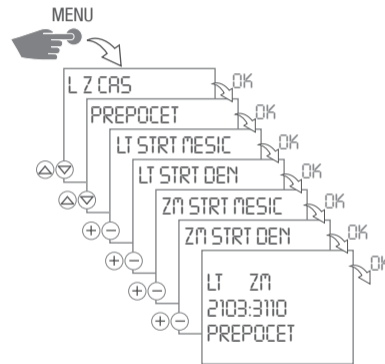

Možná nastavení:

### AUTO

S časem přednastaveným výrobcem podle platných zákonů (SEČ). Přepočítává se každým rokem.

### NE

Žádná změna.

### PREPOCET

Ruční programování. Znamená, že dojde k přepisu přednastavení výrobce. Naprogramovaný letní/zimní čas se před začátkem roku pokaždé znovu automaticky přepočítává. K přepnutí dochází ve stejný zadaný den ve stejném týdnu příslušného měsíce.



## Vytvoření programu

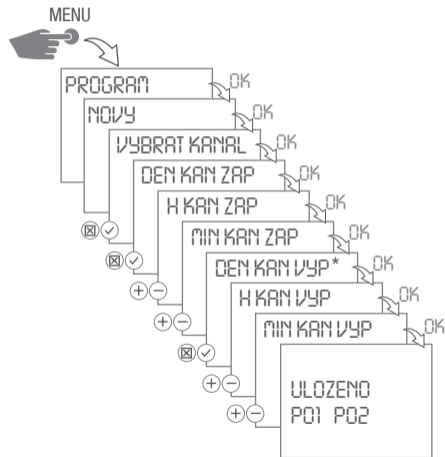

\*) K dispozici jen v případech, kdy zvolíte příkaz k ZAP s výběrem jednotlivých dní.



1. Stiskněte tlačítko MENU.
2. **PROGRAMM** potvrďte tlačítkem **OK**.
3. Poté potvrďte **NEU** tlačítkem **OK**.
  - ▷ Na okamžik se objeví volná paměťová místa.
4. Jen u 2kanálové verze:
  - vyberte kanál  a potvrďte pomocí  . → **OK**
  - ▷ Pole s dny v týdnu bliká.

### Příkaz ZAP:

5. vyberte požadované dny  a potvrďte pomocí  . → **OK**
6. Zadejte hodinu (+/-) → **OK**
7. Zadejte minuty (+/-) → **OK**

### Příkaz VYP:

8. Na případný dotaz vyberte požadované dny  a potvrďte pomocí  . → **OK**
9. Zadejte hodinu (+/-) → **OK**
10. Zadejte minuty (+/-) → **OK**
  - ▷ Program se uloží.



## Prohlížení a upravování programu

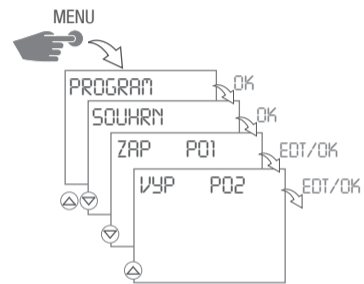

- Pomocí  $\triangle$   $\nabla$  můžete programem listovat a prohlížet si jednotlivé kroky.
- Stisknutím tlačítka **OK** se dostanete k dalšímu programu.
- Tlačítkem **EDT** přepnete na úpravy programu. Při editaci postupujete jako při zakládání nového programu.



## Vymazávání programů

### Výmaz všech programů

- Stisknutím tlačítka **ANO** vymažete všechny programy.
- Stisknutím tlačítka **NE** vymažete jednotlivé programy.

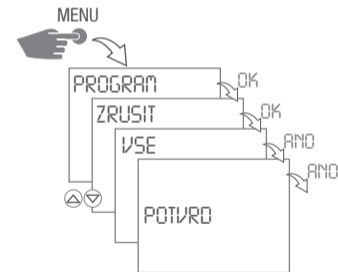

### Výmaz jednotlivých programů

- Výmazem jednotlivých programů se vymažou i všechny související programové kroky (např. P01 ZAP a P02 VYP).
- Stisknutím tlačítka **OK** se dostanete k dalšímu programu.

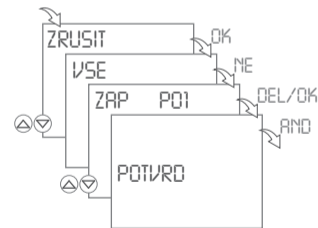





## Automatický/ruční provoz

- ruční spínač: ZAP doby / VYP doby / automatický režim
- levé tlačítko = kanál 1 /  
pravé tlačítko = kanál 2

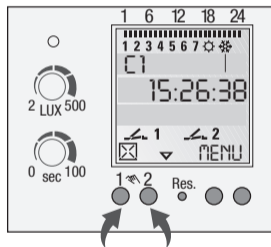

- 1x stisknutí = FIX ON = ZAP doby
- 2x stisknutí = FIX OFF = VYP doby
- 3x stisknutí = automatický režim

## Indikace spínacího stavu

— 1 = ZAP kanál

↘ 1 = VYP kanál

V automatickém režimu tato indikace nesvítí



## Likvidace / recyklace

Obal zlikvidujte řádně a v souladu se zákonnými předpisy a nařízeními.

Pro likvidaci defektních systémových komponent nebo celého systému na konci životnosti platí:

- likvidujte odborně, tj. odpad roztřídte do skupin podle materiálu.
- Elektrický či elektronický šrot v žádném případě nevyhazujte jen tak do domovního odpadu. Odneste do sběrný.
- Při likvidaci postupujte ekologicky, podle aktuálního stavu ekologické, recyklační a odpadové techniky.



## Innehållsförteckning



### Säkerhetsföreskrifter ..... 164



### Uppgifter om enheten ..... 165

Beskrivning av apparaten ..... 165

Föreskriven användning ..... 165

Tekniska data ..... 166



### Installation och montering ..... 167

Montering på DIN-skens ..... 167

Anslutning och montering av ljussensorn ..... 167

Kopplingsschema ..... 168

Idrifttagande ..... 169



### Manövrering och inställning ..... 170

Displayvisning och funktionsknappar ..... 170



Menystruktur ..... 173

Första driftstart – Val av menyspråk ..... 174

Ställa in datum och tidpunkt ..... 174

Växling mellan sommar-/vintertid ..... 175

Utarbeta program ..... 176

Visa och redigera program ..... 178

Radera program ..... 179

Automatisk/manuell drift ..... 180



### Avfallshantering/återvinning ..... 181



## Säkerhetsföreskrifter



**WARNING!**

### Livsfara på grund av elektriska stötar!

- ▷ Anslutning och montering får enbart göras av en behörig elektriker!

- Följ de nationella föreskrifterna och säkerhetsvillkoren.
- Ingrepp och ändringar på enheten leder till att garantin upphör att gälla.
- Minsta diameter för anslutningsklämmorna till de flexibla ledningarna: 1 mm<sup>2</sup>  
Maximal diameter: 4 mm<sup>2</sup>

Läs och följ denna handbok för att säkerställa en felfri funktion och ett säkert arbete för enheten.



## Uppgifter om enheten

### Beskrivning av apparaten

Skymningsströmställare

- 1 kanal eller 2 kanaler
- Inställbar TILL/FRÅN-kopplingsfördröjning:  
0 – 100 sek.
- Det går att bygga ut med upp till 10 enheter  
(20 kanaler) till ett ljusstyrssystem med endast  
en ljusgivare.
- Med veckotidkopplingsur

### Föreskriven användning

- Skymningsströmställaren används för
  - belysning på det privata och yrkesmässiga området
  - Reklambelysning
  - Gatubelysning
  - Skylfönsterbelysning
  - Parkeringsplatsbelysning
  - Styrning av jalousier
- Montering enbart på DIN-skena
- Endast lämplig för användning i torra utrymmen!



## Tekniska data

### Bryteffekt:

- ohmsk last (VDE, IEC) 16 A/250 V AC
- induktiv last  $\cos \varphi$  0,6 10 A/250 V AC
- Glöd-/halogenlamplast 2600 W
- Lysrörslampa 1000 W
- Max. bryteffekt AC1 / AC15 3700 W/750 W

### Omgivningstemperatur:

- Styrenhet/ljussensor -10 °C ... + 55 °C / -30 °C ... + 70 °C

### Skyddsart:

- Styrenhet/ljussensor IP 20/IP 65

### Skymningsströmställare:

- Inställningsområde 2 lx – 500 lx
- Kopplingsfördröjning inställbar: ca 0-100 s TILL/0-100 s FRÅN

### Tidsströmställare:

- Minnesplatser 50
- Gångnoggrannhet typ  $\pm 1$  s/dag vid +20 °C
- Gångreserv 3 år från fabriken



## Installation och montering



**WARNING!**

**Livsfara på grund av elektriska stötar!**

▷ Anslutning och montering får enbart göras av en behörig elektriker!

### Montering på DIN-skena

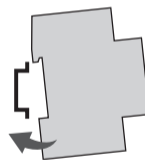

Sätt enheten på skenan lite snett uppifrån. Tryck sedan bakåt tills enheten går i ingrepp.

### Anslutning och montering av ljussensorn

1



2

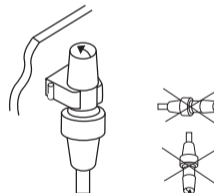

- Anslutningskabelns längd: max. 100 m
- Ledartvärsnitt: min. 2 x 0,75 mm<sup>2</sup>



## Kopplingsschema

- ⚠ Vid anslutning av sensorn till uttagen + och - måste du även göra en brygga mellan uttagen B1 och B2.
- Om du driver flera enheter med en sensor får denna brygga endast göras på en enhet.

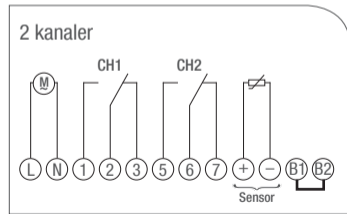
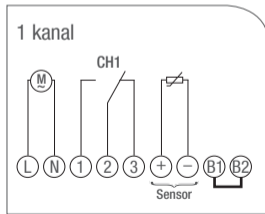

## Idrifttagande

- ⚠ Vid anslutning av sensorn till uttagen + och - måste du även göra en brygga mellan uttagen B1 och B2.
- Om du driver flera enheter med en sensor får denna brygga endast göras på en enhet.

- Enheten - skymningsströmställare och tidsströmställare - kopplar utgången (uttag 1 och 5) aktiv enbart om alla tre villkoren är uppfyllda:
- det inställda ljusvärdet har underskridits
  - den inställda fördröjningstiden har underskridits
  - tidsströmställaren är på = TILL

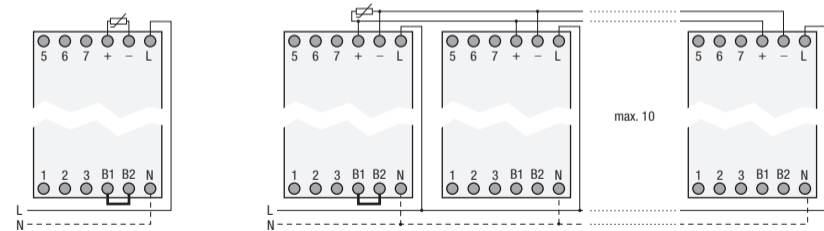



## Manövrering och inställning

### Displayvisning och funktionsknappar

- Den mittre raden på displayen, som visar de värden som skall ställas in och de menypunkter som skall väljas, visas stort.
- Blinkning signalerar en nödvändig inmatning. Om ingen inmatning sker inom två minuter återgår strömställaren till automatisk drift.
- Vid en reset bibehålls programmen. Datum och klockslag måste ställas in på nytt. Tryck på reset-knappen med ett trubbigt föremål (kulspetspenna).

### Inställning av luxvärdet

Ställ inställningsknappen på det önskade luxvärdet (2 - 500 lux).

- ▷ LED lyser så snart det inställda luxvärdet underskrider ljuset i omgivningen.

### Inställning av fördröjningstiden

Ställ in inställningsknappen på den önskade fördröjningstiden (0 - 100 sek).

- ▷ Minskning av felkopplingar på grund av kortvarig yttre ljuspåverkan som blixtrar etc.

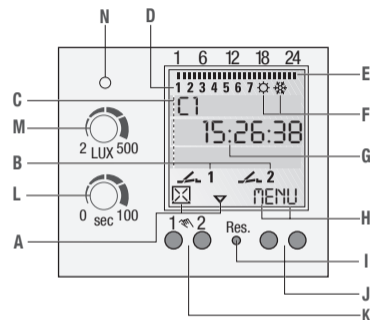

### Knappar/brytare

- I Reset
- J De högra knapparna
- K De vänstra knapparna med manuell brytarfunktion Automatisk drift

### Display

- A De båda vänstra knapparnas funktionsvisningar
- B Visning av kopplingstillståndet
- C Tre displayrader
- D Visning av veckodag
- E Översikt dagkopplingsprogram
- F Visning av sommar-/vintertid
- G Driftspänning (permanenta punkter) Gångreservdrift (punkter blinkar)
- H De båda högra knapparnas funktionsvisningar
- L Inställningsknapp TILL-/FRÅN-kopplingsfördröjning
- M Inställningsknapp luxvärde
- N Kopplingstillståndvisning utan fördröjning



### De båda vänstra knapparnas funktionsvisningar:

- △ Bläddra uppåt på menyn
- ▽ Bläddra neråt på menyn
- ☒ Avslå val
- ✓ Godta val
- + Kort tryck = +1/långt tryck (ca 2 sek) = +5
- Kort tryck = -1/långt tryck (ca 2 sek) = -5

### De båda högra knapparnas funktionsvisningar:

**MENU** Lämna den automatiska driften och övergång till programmeringsläget

**ESC** Kort tryck = ett steg tillbaka

Långt tryck (ca 2 sek) = tillbaka till den automatiska driften

**OK** Gör valet och godkänn det

**EDT** Ändra programmet till "Läsläge"

**NO** Utför inte kommandot

**YES** Utför kommandot

**DEL** Radera



### Menystruktur

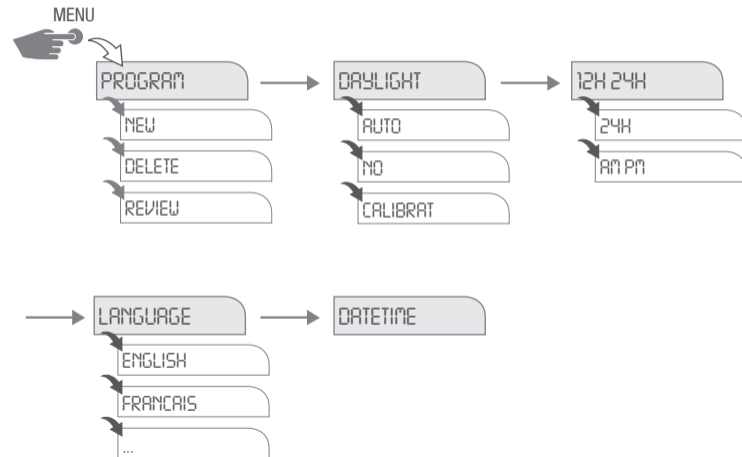



## Första driftstart – Val av menyspråk

**i** I leveranstillståndet befinner sig förde-  
larströmställarna i automatisk drift med  
förinställd tid, datum (MEZ) och engelska  
som menyspråk  
För att göra inställningar trycker du på me-  
nyknappen. Sedan väljer du den önskade  
inställningen.

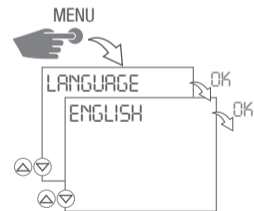

## Ställa in datum och tidpunkt

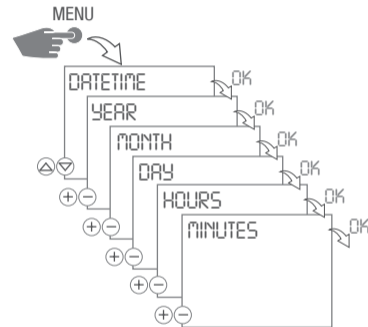

**i** På menyn **12H 24H** kan du välja mellan AM/  
PM och 12/24-timmarsvisning.



## Växling mellan sommar-/vintertid

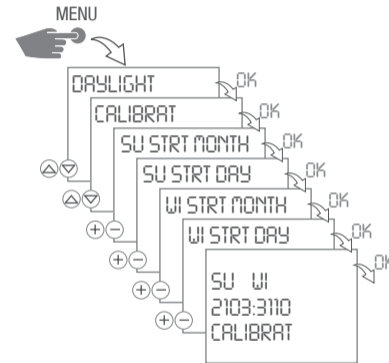

Följande inställningar är möjliga:

### AUTO

Fabriksinställning av det normalvärde som  
lagstiftningen kräver (MEZ). Denna beräknas på  
nytt varje år.

### NO

Ingen omställning.

### CALIBRAT

Manuell programmering. Fabriksinställningen  
skrivs över. Den programmerade sommar-/  
vintertiden beräknas på nytt automatiskt för  
varje år. Omkopplingen sker på samma inmatade  
veckodag i samma vecka i månaden.





## Utarbeta program

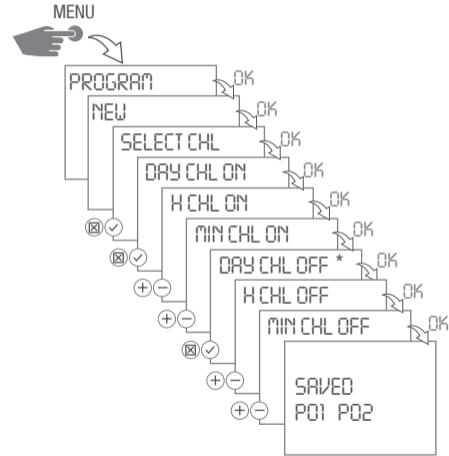

\*) Kan endast väljas om enstaka dagar väljs vid TILL-kommando.



1. Tryck på menyknappen.
2. Bekräfta **PROGRAM** med **OK**.
3. Bekräfta **NEW** med **OK**.
  - ▷ De lediga minnesplatserna visas kortvarigt.
4. Endast vid tvåkanalsversion: Välj kanal  och bekräfta med  . → **OK**
  - ▷ Visning för veckodagar blinkar.

TILL-kommando:

5. Välj önskade dagar  och bekräfta med  . → **OK**
6. Mata in timme (+/-) → **OK**
7. Mata in minuter (+/-) → **OK**

FRÅN-kommando:

8. Vid en fråga om detta väljer du önskade dagar  och bekräftar med  . → **OK**
9. Mata in timme (+/-) → **OK**
10. Mata in minuter (+/-) → **OK**
  - ▷ Programmet sparas.



## Visa och redigera program

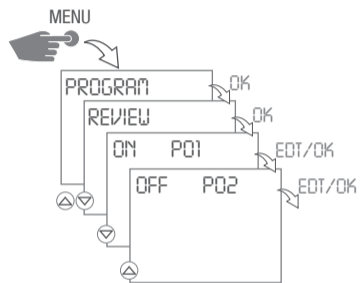

- Med  $\triangle$   $\nabla$  kan du bläddra genom programstegen.
- Tryck på **OK** för att komma till nästa program.
- Tryck på **EDT** för att redigera det aktuella programmet.  
Tillvägagångssättet motsvarar det som används när man skapar ett nytt program.



## Radera program

### Radera alla program

- Tryck på **YES** för att radera alla program.
- Tryck på **NO** för att radera enstaka program.

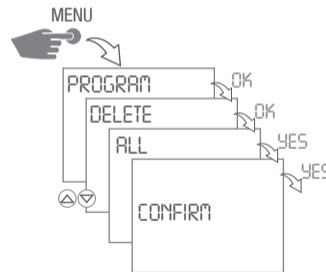

### Radera enstaka program

- Vid radering av enstaka program raderas alla tillhörande programsteg (t.ex. P01 TILL och P02 FRÅN).
- Tryck på **OK** för att komma till nästa program.

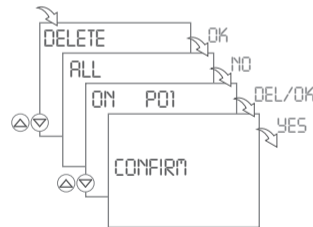



## Automatisk/manuell drift

- Manuell brytare: Tid TILL/Tid FRÅN/  
Automatisk drift
- Vänster knapp = kanal 1  
Höger knapp = kanal 2

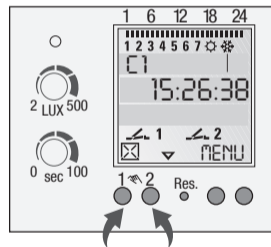

- 1x tryck = FIX ON = tid TILL
- 2x tryck = FIX OFF = tid FRÅN
- 3x tryck = automatisk drift

## Visning av kopplingstillstånd

↖ 1 = kanal TILL

↗ 1 = kanal FRÅN

I automatisk drift sker ingen visning.



## Avfallshantering/återvinning

Förpackningsmaterialet måste hanteras korrekt i enlighet med bestämmelserna i lagstiftningen och förordningarna.

För hanteringen av defekta systemkomponenter eller systemet efter produktens livslängd måste du beakta följande anvisningar:

- Avfallshandera korrekt, dvs. separerat enligt materialgrupp för de delar som skall avfallshandera.
- Kasta aldrig el- eller elektronikskrot i de vanliga soporna. Lämna detta avfall på särskilda återvinningsstationerna.
- Hantera avfallet principiellt så miljövänligt som det är möjligt med den aktuella tekniken för miljöskydd, återvinning och avfallshantering.



## Innholdsfortegnelse



### Sikkerhetsinstrukser..... 184



### Produktdetaljer ..... 185

Beskrivelse av apparatet..... 185

Forskriftsmessig bruk ..... 185

Tekniske data ..... 186



### Installasjon og montering ..... 187

Montering på DIN-skiner ..... 187

Tilkobling og montering av lysstyrkesensoren ..... 187

Koblings skjema ..... 188

Oppstart ..... 189



### Bruk og justering ..... 190

Display og funksjonstaster ..... 190



Menystruktur ..... 193

Første oppstart – Velg menyspråk..... 194

Stille inn dato og klokkeslett ..... 194

Skifte mellom sommer-/vintertid..... 195

Generere et program ..... 196

Se og redigere et program ..... 198

Slette programmer..... 199

Automatisk/manuell drift..... 200



### Avfallsbehandling / Gjenvinning ..... 201



## Sikkerhetsinstruksjer



**ADVARSEL**

### Fare for elektrisk sjokk!

- ▶ Tilkobling og montering skal utelukkende foretas av autorisert elektriker!

- Følg de nasjonale forskrifter og sikkerhetskrav.
- Garantien bortfaller dersom det foretas inngrep i eller forandringer på apparatet.
- Minimum diameter på de fleksible ledningene for tilkoblingsklemmene: 1mm<sup>2</sup>. Maksimum diameter: 4mm<sup>2</sup>

Les og følg denne bruksanvisningen for å sikre en feilfri apparatfunksjon og en sikker bruk.



## Produktdetaljer

### Beskrivelse av apparatet

Skumringsbryter

- 1 kanal eller 2 kanal
- Justerbar PÅ-/AV koblingsforsinkelse: 0 – 100 sek.
- Opptil 10 apparater (20 kanaler) kan bygges ut til ett lyskontrollsystem med kun en lysstyrkesensor.
- Med uketidsur

### Forskriftsmessig bruk

- Skumringstidsuret brukes til
  - belysning i private hjem og i handel
- reklamebelysning gatelys belysning i butikkvinduer belysning på parkeringsplasser kontroll av rullegitter og sjalusier Montering kun på DIN-skiner.
- Egner seg kun til bruk i tørre rom!



## Tekniske data

### Koblingseffekt:

– ohmsk last (VDE, IEC)	16 A / 250 V AC
– induktiv last $\cos \varphi$ 0,6	10 A / 250 V AC
– Gløde-/halogenlampelast	2600W
– Lysrørslampe	1000W
– Maks. koblingseffekt AC1 / AC150	3700W / 750W

### Mgivelsestemperatur:

– Kontrollenhet / lysstyrkesensor	-10°C ... + 55°C / -30°C ... + 70°C
-----------------------------------	-------------------------------------

### Beskyttelsestype:

– Kontrollenhet / lysstyrkesensor	IP 20 / IP 65
-----------------------------------	---------------

### Skumringsbryter:

– Justeringsområde	2 lx – 500 lx
– Koblingsforsinkelse	justerbar: ca. 0-100 s PÅ/0-100 s AV

### Tidsur:

– Minneplasser	50
– Nøyaktighet	type $\pm$ 1 s/dag ved +20°C
– Reserve	3 år fra fabrikken



## Installasjon og montering



**ADVARSEL**

**Fare for elektrisk sjokk!**

▷ Tilkobling og montering skal utelukkende foretas av autorisert elektriker!

### Montering på DIN-skiner

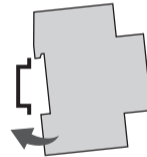

Sett apparatet lett på skrå øverst på skinnen. Trykk det så bakover til det smetter i.

### Tilkobling og montering av lysstyrkesensoren

1



2

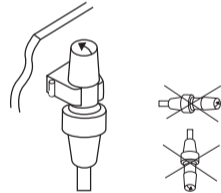

- Lengde på tilkoblingsledningen: maks. 100 m
- Ledningstverrsnitt: min. 2 x 0,75 mm<sup>2</sup>



## Koblingsskjema

- ⚠ Kobles sensoren til klemmene + og –, må det også kobles til en ledningsbro mellom klemmene B1 og B2.  
Dersom du bruker flere apparatet med en sensor, skal denne ledningsbroen kun opprettes på ett apparat.

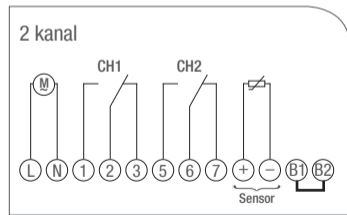
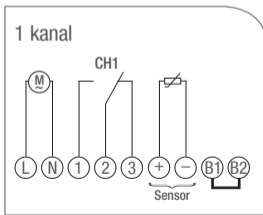

## Oppstart

- ⚠ Kobles sensoren til klemmene + og –, må det også kobles til en ledningsbro mellom klemmene B1 og B2.  
Dersom du bruker flere apparatet med en sensor, skal denne ledningsbroen kun opprettes på ett apparat.

- Apparatet - skumringsbryter og tidsur - aktiverer utgangen (klemme 1 og 5) kun når alle de tre følgende vilkårene er oppfylt:
- lysstyrken ligger under innstilt verdi
  - den innstilte forsinkelsestiden er ommetidsuret er satt på = PÅ

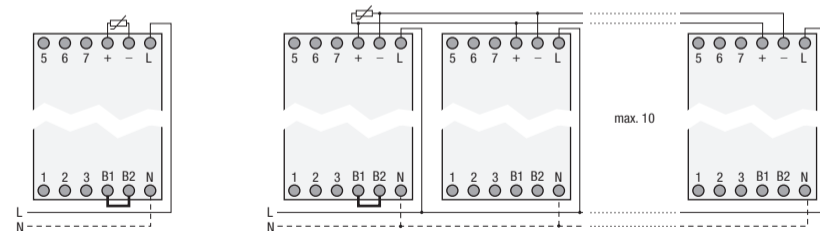



## Bruk og justering

### Display og funksjonstaster

- Den midterste linjen på displayet viser verdiene som skal innstilles og menypunktene som kan velges, vises med stor skrift.
- Blinking signaliserer at det må taster inn en verdi. Taster du ikke inn noe på to minutter, går tidsuret tilbake til automatisk drift.
- Programmene bevares ved en tilbakestilling. Du må stille inn dato og klokkeslett på nytt. Trykk på Reset-knappen med en butt gjenstand (kulepenn).

### Innstilling av luxverdien

- Still dreiebryteren på ønsket luxverdi (2- 500 lux).
- ▷ LED'en tennes så snart lysstyrken i omgivelsene er lavere enn innstilt luxverdi.

### Innstilling av forsinkelsestid

- Still dreiebryteren på ønsket forsinkelsestid (0 - 100 sek).
- ▷ Reduserer antall feilkoblinger på grunn av korte ytre lyseffekter som lyn etc.

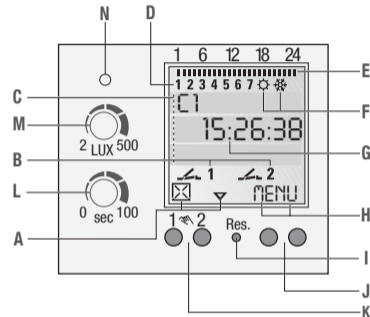

### Display

- A Funksjonsvisning for de to venstre knappene
- B Viser koblingsstatus
- C 3 Display-linjer
- D Viser ukedag
- E Oversikt daglig koblingsprogram
- F Viser sommer-/vintertid
- G Driftsspenning (permanente prikker)  
Gangreservedrift (prikkene blinker)
- H Funksjonsvisning for de to høyre knappene

### Knapper/brytere

- I Tilbakestill
- J Høyre knapper
- K Venstre knapper med manuell bryterfunksjon i Automatisk modus
- L Dreiebryter PÅ-/AV-koblingsforsinkelse
- M Dreiebryter luxverdi
- N Visning av koblingsstatus uforsinket





### Funksjonsvisning for de to venstre knappene:

- △ Bla oppover i menyen
- ▽ bla nedover i menyen
- ☒ Avvise forslag
- ✓ Akseptere forslag
- + Trykk kort = +1 / Trykk lenge (ca. 2 sek) = +5
- Trykk kort = -1 / Trykk lenge (ca. 2 sek) = -5

### Funksjonsvisning for de to høyre knappene:

- MENU** Forlater automatisk drift og går inn i programmeringsmodus
- ESC** Trykk kort = ett skritt tilbake  
Trykk lenge (ca. 2 sek) = Tilbake til automatisk drift
- OK** Velg og overta
- EDT** Endre programmene i „Lesemodus“
- NO** Ikke utfør kommando
- YES** Utfør kommando
- DEL** Slett



### Menystruktur

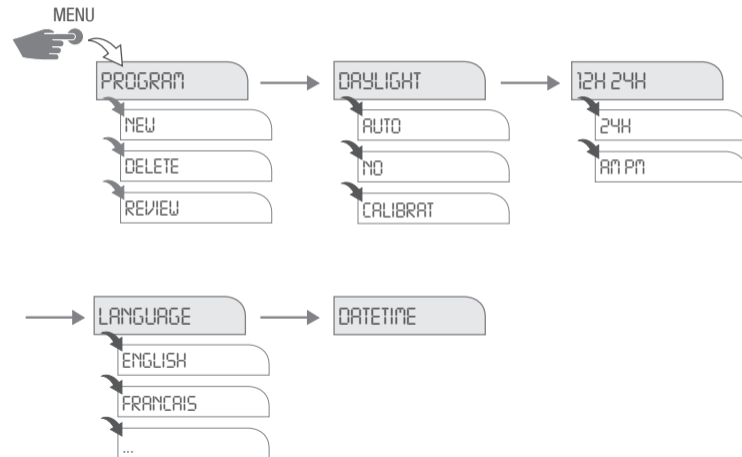



## Første oppstart – Velg menyspråk

**i** Ved levering er timeuret i automatisk drift med forhåndsinnstilt klokkeslett, dato (MEZ) og engelsk menyspråk. Trykk menyknappen for å foreta innstillinger. Velg deretter ønsket innstilling.

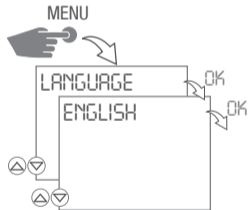

## Stille inn dato og klokkeslett

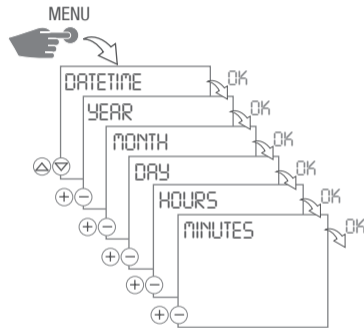

**i** I meny 12H 24H kan du velge mellom AM/PM og 12/24-timers visning.



## Skifte mellom sommer-/vintertid

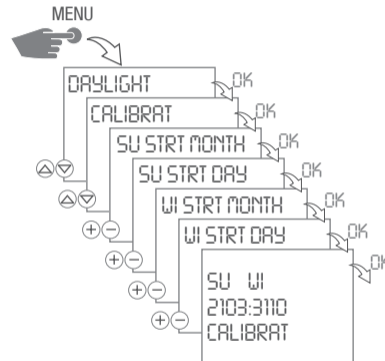

Følgende innstillinger kan foretas:

### AUTO

Preinnstilling av lovfestede kalenderdata (MEZ). Disse beregnes automatisk på nytt hvert år.

### NO

Ingen omstilling.

### CALIBRAT

Manuell programmering. Preinnstillingene blir overskrevet. Programmert sommer-/vintertid beregnes automatisk på nytt hvert år. Omstillingen skjer på samme spesifiserte ukedag i samme uke hver måned.



## Generere et program

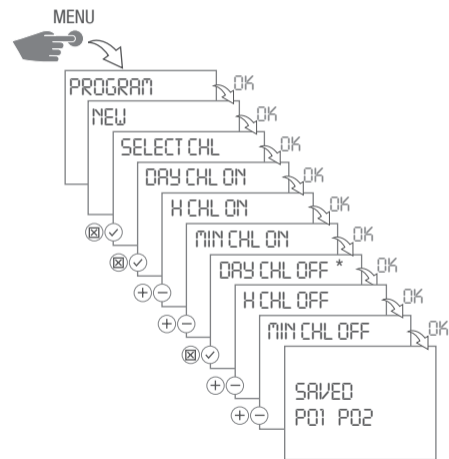

\*) Tilgjengelig kun dersom individuelle dager er blitt valgt ved PÅ-kommando.



1. Trykk menyknappen.
2. **PROGRAM** med **OK**.
3. **NEW** med **OK**.
  - ▷ Ledig minneplass vises kort.
4. Kun for 2-kanal versjon: Velg kanal og bekreft med **.** → **OK**
  - ▷ Ukedagen blinker.

### PÅ-kommando:

5. Velg ønsket dag og bekreft med **.** → **OK**
6. Tast inn time (+/-) → **OK**
7. Tast inn minutt (+/-) → **OK**

### AV-kommando:

8. Ved forespørsel, velg ønsket dag og bekreft med **.** → **OK**
9. Tast inn time (+/-) → **OK**
10. Tast inn minutt (+/-) → **OK**
  - ▷ Programmet lagres.



## Se og redigere et program

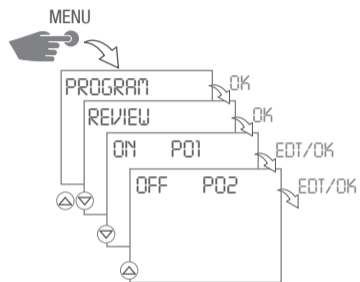

- Med kan du bla gjennom programskrittene.
- Trykk **OK** for å komme til neste program.
- Trykk **EDT** or å bearbeide programmet. Fremgangsmåten er den samme som for å generere et nytt program.



## Slette programmer

### Slette alle program

- Trykk **YES** for å slette alle programmer.
- Trykk **NO** for å slette enkelte programmer.

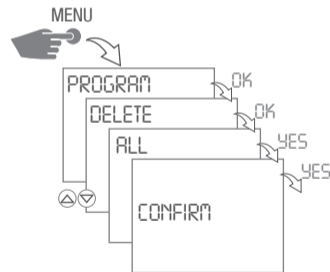

### Slette enkelte programmer

- Ved sletting av enkelte programmer slettes alle tilhørende programskritt (f.eks. P01 PÅ og P02 AV).
- Trykk **OK** for å komme til neste program.

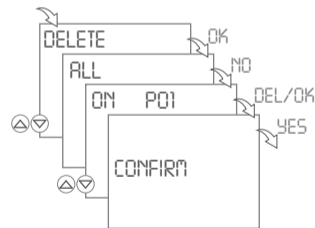



## Automatisk/manuell drift

- Manuell bryter: Permanent PÅ / Permanent AV / Automatisk drift
- Venstre knapp = kanal 1  
Høyre knapp = kanal 2

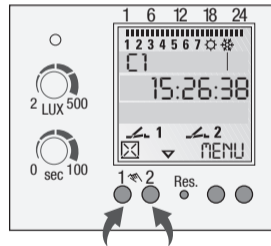

- 1x trykk = FIX ON = permanent PÅ
- 2x trykk = FIX OFF = permanent AV
- 3x trykk = automatisk drift



## Avfallsbehandling / Gjenvinning

Emballasjematerialet skal avfallsbehandles i henhold til de lovfestede bestemmelser og direktiver.

Legg merke til følgende ved avhending av defekte systemkomponenter eller systemet etter endt levetid:

- Delene som skal avhendes, deponeres korrekt, dvs. kildesortert etter materialgrupper.
- Ikke kast elektriske eller elektroniske komponenter i vanlig søppel. Lever dem inn til egnede mottaksentraler.
- Avhend avfall på en miljøvennlig måte i henhold til aktuelt nivå innen miljøvern, gjenvinning og avfallsteknikk.

