

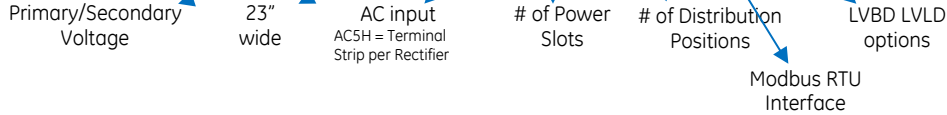

# Infinity S (NE-S) -48V/+24V Aluminum Bus System

NES4824-23-AC5H-PS12-DC52A\_M-LVBD-LVLD



Read and follow all safety statements and precautions in this guide.

Tools required: Cable crimpers	Torque wrench (0-240 in-lb / 28 Nm) Screw Drivers (#1 Flat & #2 Phillips)	Sockets—5/16," 7/16" 1/2", and 9/16" Wire cutters and strippers
-----------------------------------	------------------------------------------------------------------------------	--------------------------------------------------------------------

## Step 1 - Mount the System

Mount the system with a minimum gap of 3 inches behind the system to allow proper airflow.

1. Remove non-conductive coating from mounting rails of frame and apply antioxidant if separate chassis ground is not provided.
2. Attach the system to the frame using a minimum of twelve (six on each side) 12-24 screws (provided).  
Torque to 35 in-lb (7.3 Nm) - 5/16" socket.

## Step 2 - Connect Chassis and DC Reference (CO) Ground

1. Connect Chassis Ground - unless grounded via mounting - above.  
Minimum 10 AWG recommended  
Lug Landing - #10 on 5/8" centers (lug not provided).  
Torque to 35 in-lb (7.3 Nm) - 5/16" socket.
2. Connect DC reference ground  
Lug Landing - 5/16" on 1" centers (lug not provided).  
Torque to 160 in-lb (18 Nm) - 1/2" socket.

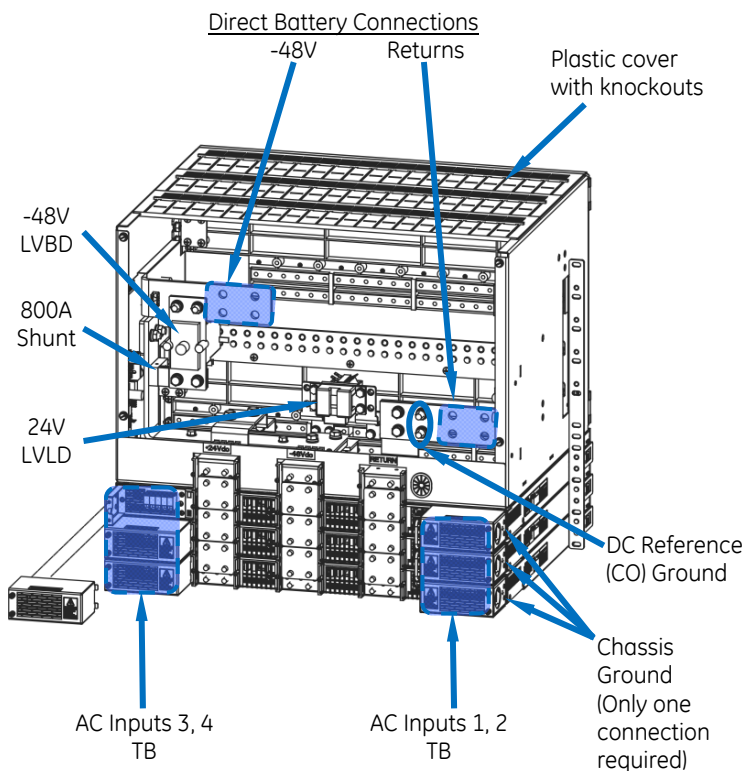

## Step 3 - Connect AC Input

Connect 120/208/220VAC in ac boxes at rear of each rectifier shelf. One rectifier per feed.

**Danger:** Turn OFF and lock-out tag-out the AC source before making AC connections. When connecting to AC mains, follow all local and national wiring rules.

**Caution:** When routing AC ensure cables do not come in contact with sharp or rough surfaces that may damage insulation and cause a short circuit.

Knockout: 3/4" conduit or cord grip - each side

Wire: 10 AWG max.

Strip: 0.35" (9 mm) Torque: 6 in-lb (7 Nm)

Breakers: see *Information: Rectifier and Converter Options*

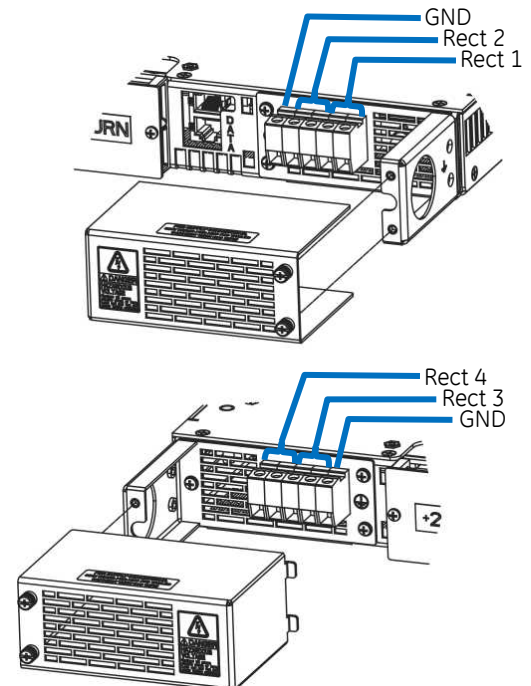

### Step 4 - Connect Batteries and DC Output to Loads

The figure to the right shows the DC circuit of the system.

**Battery** connections are made directly to the battery bus or to bullet-style distribution positions on Panel A.

**CAUTION:** Verify battery voltage and polarity with a voltmeter before connecting.

**Load** connections are made to bullet-style distribution positions.

The distribution panel is equipped with 2 rows of 26 bullet-style distribution positions.

**Top Row:** 26 positions each selectable between (Panel A) battery and -48V load output.

**Bottom Row:** 26 positions each selectable between (Panel B) +24V load output and -48V load output.

+24V positions 1-13 (left) are noncritical - disconnected by the LVLD when operated.

Breakers up to 250A are available.

Turn breakers OFF before inserting.

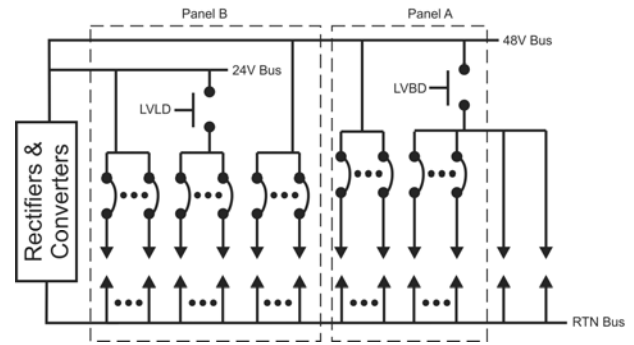

Lug Landings	
Breakers	Battery Bus (rear)
1/4-20 studs on 5/8" centers	3/8" on 1" centers
Lug tongue width 0.68" max	Torque: 240 in-lb - 9/16" socket
	Torque: 65 in-lb - 7/16" socket



Panel A (upper panel)

Upper Breaker position for battery -48V  
Battery Breakers have Yellow Handle

Lower Breaker position for -48V load

#### Breaker Position Colors

- Blue -48V Load
- Orange +24V load
- Yellow -48V Battery

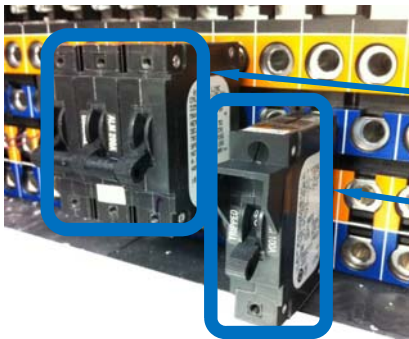

Panel B (lower panel)

Upper Breaker position for +24V load

Lower Breaker position for -48V load



Correct Breaker Orientation for Insertion  
Ensure alarm pin inserts into alarm socket of panel.

Multi-pole adapter kits are required for each multi-pole breaker - figure below.

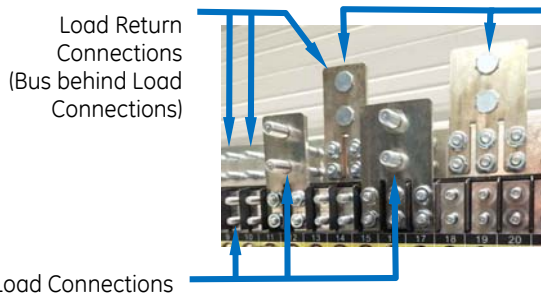

Return Bus Adapters  
Face lug studs to the rear.

Multi-Pole Adapter Kits - 2 required per breaker			
	CC848756916	850021775	850021955
Poles	2	2	3
Lug Landings	1/4" x 5/8"	3/8" x 1"	3/8" x 1"



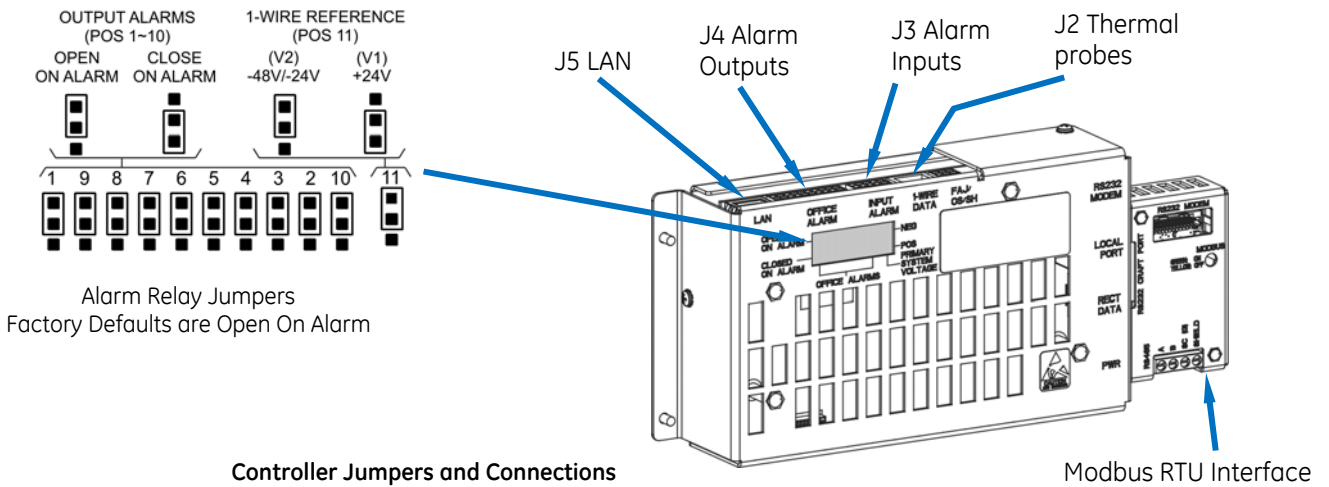

Controller Jumpers and Connections

Modbus RTU Interface

### Step 5 - Set Controller Jumpers

Set jumpers 1 thru 10 for the ten alarm relays as Close on Alarm or Open on Alarm; Factory default setting is Open on Alarm.

### Step 6 - Controller Connections

Connect per site engineering instructions.

**Alarm Wires** See *Information: Controller Connections*

J4 OFFICE ALARM Alarm Outputs

J3 INPUT ALARM Alarm Inputs

#### LAN

J5 LAN Ethernet LAN or local PC connection

#### Modbus RTU Interface

Connect and configure Modbus RTU Interface per *Pulsar Plus Modbus RTU Interface Quick Start Guide*.

#### 1-Wire Battery Temp and Voltage Monitor - Optional

J2 1-Wire Data See *Information: Battery Monitoring Connections*.

### Step 7 - Install Rectifiers and Converters

Slide the unit into the power slot approximately 3/4 of the way.

Open the faceplate by sliding the faceplate latch to the left until the faceplate releases and swings outward.

Slide the unit into the slot until it engages with the back of the shelf. Swing the faceplate closed to fully seat the rectifier. Verify the faceplate is latched.

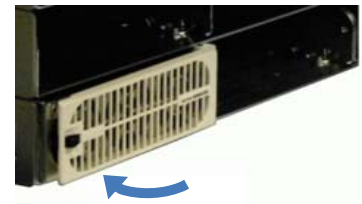
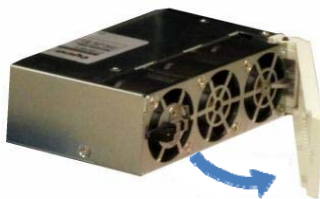

### Step 8 - Initial Start Up

Verify that all AC, DC and Controller connections are complete and secure. Turn on AC input breakers. If there are no alarms, make required adjustments to the default settings on the controller for this installation.

### Step 9 - Configure Controller

Verify and edit controller basic configuration parameters per site engineering instructions.

Refer to Galaxy Pulsar Plus Controller Family Product Manual



## Information: Controller - LAN Port - Local / Network

The LAN port is be configured as Local or Network -

controller display menu path **Configuration**→**Communication Ports**→**Network Settings**→**DHCP**→mode **CLIENT** or **SERVER**

**CAUTION:** Do not connect LAN port to a network when configured as Local.

**Local** (Server): LAN connects to a laptop.

Local (Server) is a temporary setting. When configuration is complete, return LAN port to Network (Client) mode.

**Network** (Client): LAN connects to a network. (Default).

See *Pulsar Plus Controller Family Product Manual* for details.

## Information: Controller Basic Operation

View and change system parameters from the factory defaults via

A) Controller Display

B) Craft Port on front of controller using a laptop with EasyView2 software or HyperTerminal.

EasyView2 (GUI) software can be downloaded from [www.gecriticalpower.com](http://www.gecriticalpower.com).

C) J5 LAN port web pages using a laptop with browser. LAN port Server mode is for local laptop connection. Set the LAN port to Server:

With the controller set to Server enter the default IP address 192.168.2.1 (default) in the web browser address field.

**Warning:** Do not connect J5 LAN port to a network when set to Server. Set the controller to Client or Static before connecting to the network. Static is the factory default setting and the typical setting for most networks.

**Controller Alarm Status:** The display changes colors; Green = Normal, Amber = Minor Alarm, Red = Critical/Major Alarm

**Some alarms may occur during initial installation;** example: *thermal probe fail* or *Major/Minor communication fail*.

Clear these alarms: Via Controller Display: follow the menu path; *Menu > Control/Operation > Clear Events* or *Uninstall Equipment*.

Via web pages or EasyView2; Select the *Maintenance* tab > *clear latched events* and *clear missing devices*.

**Verify Basic Installation Settings:** Date, Time, Battery Type, number of strings and float voltage

**Controller Display** - *Menu > Configuration > System Settings* and *Menu > Configuration > Batteries*.

**Web pages** or **EasyView2** - *Installation Tab* for Date, Time. Site ID and Site Description.

*Settings Tab > Battery Management* for Battery Type and number of battery strings installed.

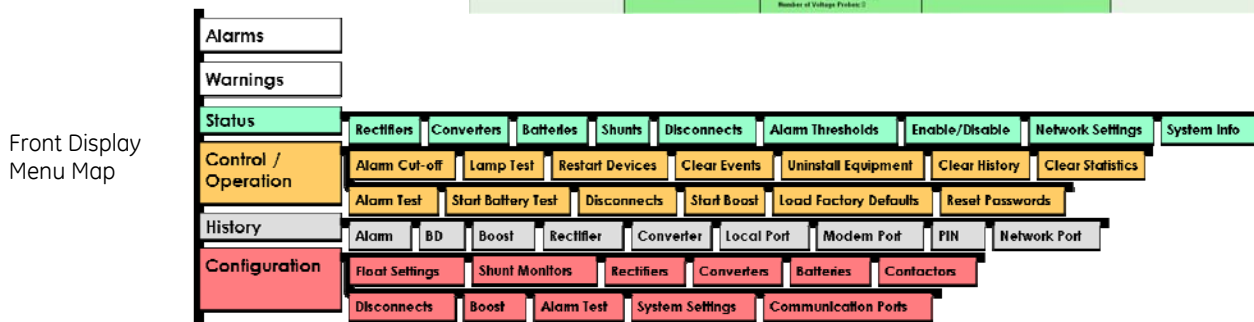
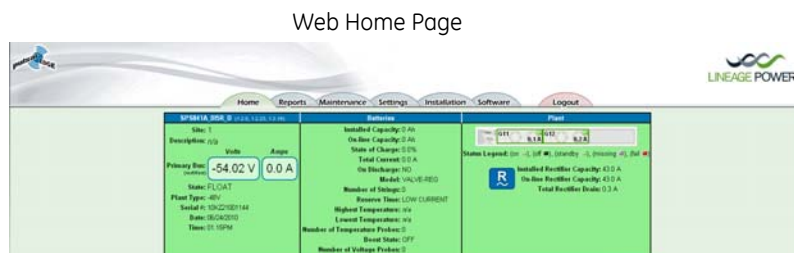
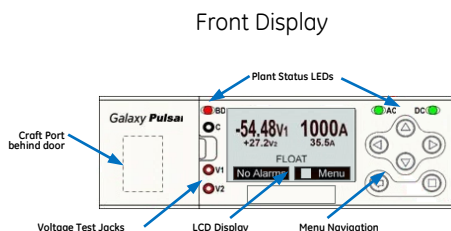

## Information: Controller Default Voltage Settings and Ranges

Parameter	Range		Valve-Reg Default		Flooded		NiCd	
	-48V	+24V	-48V	+24V	-48V	+24V	-48V	+24V
Rectifier Float Selective High Voltage Shutdown	-50 to -60V	25 to 30V	58.50	29.25	58.50	29.25	58.50	29.25
High Float Voltage Major Alarm	-50 to -60V	25.74 to 31.75V	57.00	28.24	57.00	28.24	57.00	28.24
High Float Voltage Minor Alarm	-50 to -60V	24.75 to 29.75V	56.00	27.74	56.00	27.74	56.00	27.74
Rectifier/System Float Voltage	-42 to -56.5V	21 to 28V	54.48	27.24	52.08	26.04	54.40	27.20
Battery on Discharge Float Alarm	-46 to -55V	23 to 28V	51.00	25.54	50.00	25.54	51.00	25.54
Very Low Float Voltage Alarm	-40 to -51V	20 to 25.5V	46.00	23.00	46.00	23.00	46.00	23.00
Rectifier On Threshold	-40 to -51V	20 to 25.5V	44.00	22.00	44.00	22.00	44.00	22.00





### Information: Battery Monitoring Connections

Battery Monitoring is accomplished with a "Daisy Chained" series of probes connected to J2. The Probes monitor battery temperature and voltage (ES771 required to monitor voltage). Bolt the Probe under the "-" terminal connector hardware; NOT under the connecting lug.

Max per system: Probes - 16, ES771 Modules - 6.

Battery Temperature Measurement

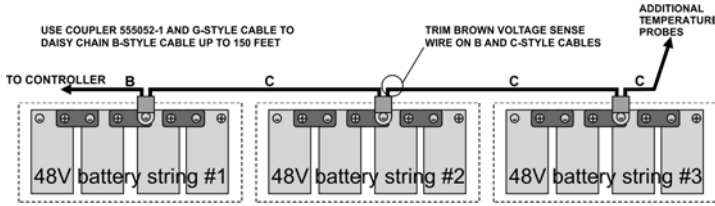

Ordering Codes	Descriptions
CC109142980	QS873A Battery Thermal Probe
150026698	QS873B Ambient Probe
CC848817024	B 10' controller to thermal probe wireset
CC109157434	B 20' controller to thermal probe wireset
CC848822560	C 1' thermal probe to thermal probe wireset
848719803	C 5' thermal probe to thermal probe wireset
CC848822321	C 10' thermal probe to thermal probe wireset
850037334	C 20' thermal probe to thermal probe wireset

Battery Temperature and Voltage Measurement

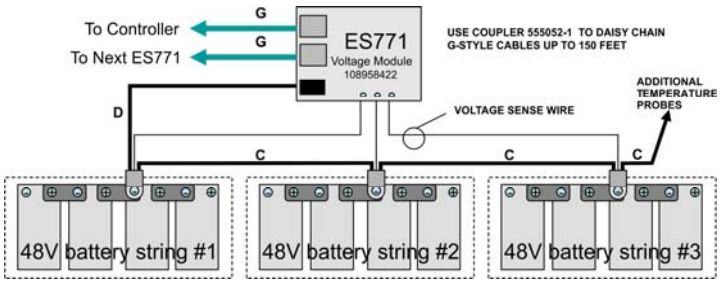

Ordering Codes	Descriptions
108958422	ES771A Voltage Monitor Card
CC848791517	D 2 1/2' ES771A to probe wireset
CC848797290	D 6' ES771A to probe wireset
848719829	D 10' ES771A to probe wireset
CC848791500	G 4' ES771A to ES771A or controller wireset
848652947	G 10' ES771A to ES771A or controller wireset

### Information: Controller Connections

#### Alarm Outputs

Alarm relays are factory set to Open On Alarm. If Close On Alarm is desired adjust controller alarm jumpers. See diagram in step 5 for the location of the controller alarm jumpers. Connector J4 provides access to the primary customer alarm outputs. J4 is a 20-pin latching connector.

Standard Controller Alarm Output Defaults		Pin	Color Option 1	Color Option 2
PCR	Power Critical	1	BL	BL
PCR_C	Power Critical_C	11	W	BL/BK
PMJ	Power Major	2	O	O
PMJ_C	Power Major_C	12	W	O/BK
PMN	Power Minor	3	G	G
PMN_C	Power Minor_C	13	W	G/BK
R1	Battery On Discharge	4	BR	W
R1_C	Battery On Discharge_C (BD_C)	14	W	W/BK
R2	Very Low Voltage (VLV)	5	S	BK
R2_C	Very Low Voltage_C (VLV_C)	15	W	BK/W
R3	Fuse Alarm Major (FAJ)	6	BL	BL/W
R3_C	Fuse Alarm Major_C (FAJ_C)	16	R	BL/R
R4	AC Fail (ACF)	7	O	O/R
R4_C	AC Fail_C (ACF_C)	17	R	R
R5	Rectifier Fail (RFA)	8	G	G/W
R5_C	Rectifier Fail_C (RFA_C)	18	R	R/G
R6	Mult. Rectifier Fail (MRFA)	9	BR	W/R
R6_C	Mult. Rectifier Fail_C (MRFA_C)	19	R	R/W
R7	High Voltage (HV)	10	S	BK/R
R7_C	High Voltage_C (HV_C)	20	R	R/BK



#### Alarm Inputs

Default alarm descriptions may be changed as needed using web pages or Easyview2. J3 is a 10-pin latching connector.

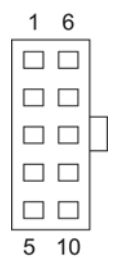

Standard Controller Alarm Input Defaults	J3 Pin	Color
Air Con Fail	1	BK
Air Con Fail_Return	8	V
Door Open	2	BR
Door Open_Return	8	V
Aux PMJ Input	3	R
Battery Test/GSTR	4	O
Battery Test_Return	9	S
EPO	5	Y
EPO_Return	10	W
Hi ext. Temp.	6	G
Hi ext. Temp_Return	8	V
Low ext. Temp.	7	BL
Low ext. Temp_Return	8	V



Alarm Output Cables		Alarm Input Cables	
CC848890137	5 ft.	CC848890153	5 ft.
CC109157442	15 ft.	CC848865980	15 ft.
CC848817635	50 ft.	CC848817651	50 ft.
CC848817643	150 ft.	CC848817668	150 ft.



## Information: Rectifier and Converter Options

Rectifier		Input	Output DC		Recommended AC Breaker
			Voltage	Current	AC5
-48V Eco Rectifier  blue	NE050ECO48ATEZ	ac 208-240 Vac	48Vdc	50A	20A
		ac 110 Vac	48Vdc	22A	20A
		dc +/-30 to +/-150) Vdc, 11A max	48Vdc	50A	15A
-48V Rectifier  blue	NE075AC48ATEZ	ac 208-240 Vac	48Vdc	75A	30A
		ac 110 Vac	48Vdc	25A	20A
	NE050AC48ATEZ	ac 208-240 Vac	48Vdc	50A	20A
		ac 110 Vac	48Vdc	22A	20A
	NE050AC48A	ac 208-240 Vac	48Vdc	50A	20A

Converter		Input DC		Output DC	
		Voltage	Current <sup>1</sup>	Voltage	Current
 +24V Orange	NE075DC24A	48Vdc	54A max	24Vdc	75A

## Specifications and Application

- Specifications and ordering information are in the *Infinity S Ordering Guide* available at [www.gecriticalpower.com](http://www.gecriticalpower.com)
- External Surge Protective Device (SPD) is required on all AC inputs.
- Equipment and subassembly ports:
  1. are suitable for connection to intra-building or unexposed wiring or cabling;
  2. can be connected to shielded intra-building cabling grounded at both ends.
- Grounding / Bonding Network – Connect to an Isolated Ground Plane (Isolated Bonding Network) or an Integrated Ground Plane (Mesh-Bonding Network or Common Bonding Network).
- Installation Environment - Install in Network Telecommunication Facilities, OSP, or where NEC applies.
- Battery return may be either Isolated DC return (DC-I) or Common DC return (DC-C).

## Reference Documents

These documents are available at [www.gecriticalpower.com](http://www.gecriticalpower.com).

Document	Title
CC848815341	Galaxy Pulsar Plus Controller Family Product Manual
	Infinity S Power System Brochure
850047312	Pulsar Plus Modbus RTU Interface Quick Start Guide



## Safety Statements

- Do not install this equipment over combustible surfaces.
- Rules and Regulations - Follow all national and local rules and regulations when making field connections.
- Compression Connectors
  - U. S. or Canada installations - use Listed/Certified compression connectors to terminate Listed/Certified field-wire conductors.
  - All installations - apply the appropriate connector to the correct size conductor as specified by the connector manufacturer, using only the connector manufacturer's recommended or approved tooling for that connector.
- Electrical Connection Securing: Torque to the values specified on labels or in the product documentation.
- Cable Dress - dress to avoid damage to the conductors and undue stress on the connectors.
- Circuit Breakers and Fuses
  - Use only those specified in the equipment ordering guide.
  - Size as required by the National Electric Code (NEC) and/or local codes.  
Safety Tested Limits - Refer to the equipment ratings to assure current does not exceed:  
Continuous Load (List 1) - 60% of protector rating  
Maximum Load (List 2 - typically end of discharge) - 80% of protector rating.
  - GMT Style Fuses - Use only fuses provided with safety caps.
- Field-wired Conductors - Follow all National Electric Code (NEC) and local rules and regulations.
  - Insulation rating: 90°C minimum; 105°C (minimum) if internal to enclosed equipment cabinets.
  - Size AC field-wired conductors with 75°C ampacity (NEC) equal to or greater than their panel board circuit breaker rating.
- AC and DC input disconnect/protection - Provide accessible devices to remove input power in an emergency.
- Alarm Signals - Provide external current limiting protection. Rating 60V, 0.5A unless otherwise noted.
- Grounding - Connect the equipment chassis directly to ground. In enclosed equipment cabinets connect to the cabinet AC service ground bus. In huts, vaults, and central offices connect to the system bonding network.

## Precautions

- Install, service, and operate equipment only by professional, skilled and qualified personnel who have the necessary knowledge and practical experience with electrical equipment and who understand the hazards that can arise when working on this type of equipment.
- Disconnect batteries from outputs and/or follow safety procedures while working on equipment. Batteries may be connected in parallel with the output of the rectifiers. Turning off the rectifiers will not necessarily remove power from the bus.
- Do not disconnect permanent bonding connections unless all power inputs are disconnected.
- Verify that equipment is properly safety earth grounded before connecting power. High leakage currents may be possible.
- Exercise care and follow all safety warnings and practices when servicing this equipment. Hazardous energy and voltages are present in the unit and on the interface cables that can shock or cause serious injury. When equipped with ringer modules, hazardous voltages will be present on the ringer output connectors.
- Use the following precautions in addition to proper job training and safety procedures:
  - Use only properly insulated tools.
  - Remove all metallic objects (key chains, glasses, rings, watches, or other jewelry).
  - Follow Lock Out Tag Out (LOTO) procedures: customer specified, site specific, or general as appropriate.  
Disconnect all power input before servicing the equipment. Check for multiple power inputs.
  - Wear safety glasses.
  - Follow Personal Protective Equipment requirements: customer specified, site specific, or general as appropriate.
  - Test circuits before touching.
  - Be aware of potential hazards before servicing equipment.
  - Identify exposed hazardous electrical potentials on connectors, wiring, etc.
  - Avoid contacting circuits when removing or replacing covers;.
  - Use a personal ESD strap when accessing or removing electronic components.
- Personnel with electronic medical devices need to be aware that proximity to DC power and distribution systems, including batteries and cables, typically found in telecommunications utility rooms, can affect medical electronic devices, such as pacemakers. Effects decrease with distance.



