



NES-Flex DIN with Integrated AC



NES48-19-4U-AC7-PS3-DIN15B250P-LVBD-ACSPD

NES-Flex DIN with Integrated AC is available as either a one-shelf or two-shelf power system. The system is factory-configured with LVBD, Pulsar Plus controller, AC circuit breakers, and surge protection. Two shelf system includes LVLD for 6 priority and 9 non-priority

Tools required: Torque wrench (0-40Nm) Sockets - metric and inch Cable crimpers
Screw Drivers - Phillips and flat Wire cutters and strippers

Step 1 - Mount System

Prepare the system for mounting to the frame.

1. Reposition mounting ears if required - may be moved back (up to 5").
Torque to 2.8 Nm (25 in-lb) - Phillips screwdriver.

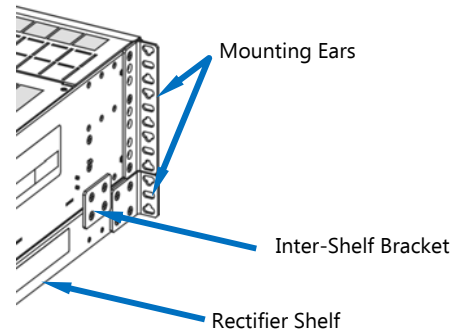

Mount the system to the frame.

1. Attach system to frame using minimum of eight screws (four per side) #12-24 screws (provided).

Step 2 - Ground Chassis

Attach ground cable to rear of system.
Torque to 4 Nm (35 in-lb) - 5/16" (8 mm) socket.

Notes:

1. Lug landing is M5 on 5/8" (16 mm) centers (lug not provided)
2. 10 mm² (10 AWG) recommended
3. Some applications may rely on frame mounting screws for chassis ground omitting the chassis ground cable

Chassis Ground

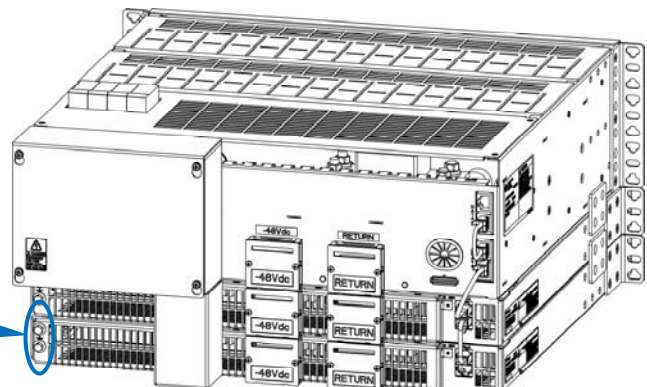

Step 3 - Connect System DC Reference (CO) Ground — make one connection to power system

Connect DC Reference Ground to left-most position on the Return Bus - M8 lug (not provided).

10 mm² (10AWG) recommended

Torque to 14 Nm (120 in-lb) - 1/2" (13 mm) socket.

DC Reference (CO) Ground

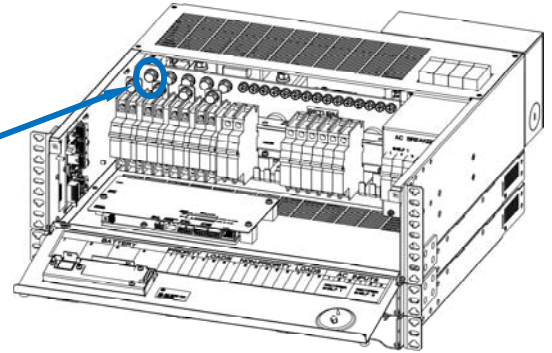

Step 4 - Connect AC Input

Connect the 5-wire 3-phase "wye" input to the AC terminal blocks.

Note: AC Input to rectifiers is line to neutral.

Danger: Turn OFF and lock-out tag-out the AC source before making AC connections. When connecting to AC mains, follow all local and national wiring rules.

Caution: When routing AC, ensure cables do not come in contact with sharp or rough surfaces that may damage insulation and cause a short circuit.

1. Remove AC Cover (four screws) - back left of unit.
2. Connect AC conduit. Remove knockout for 1" conduit either on side or bottom of box.
3. Connect **Conduit Ground Wire** - 6 mm² (8 AWG). Lug landing is M6 on 5/8" (16 mm) centers (lug not provided). Torque to 7.3 Mn (65 in-lb).
4. Insert wire in terminal blocks in this order: **Neutral, Line 1, Line**

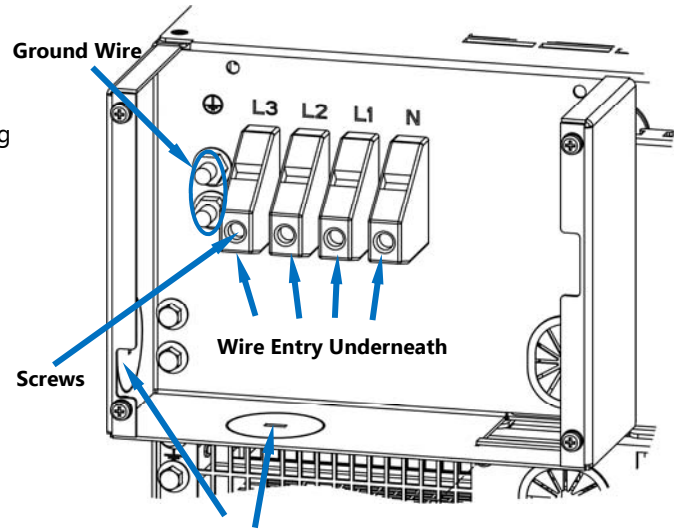

AC conduit connection knockouts for 1" con-

2,

System	Recommended Wire Gauge	Recommended External 3-Phase AC Breaker
1 shelf system	10 AWG	30A
2 shelf system	8 AWG	50A

Information: Breaker Location Diagram

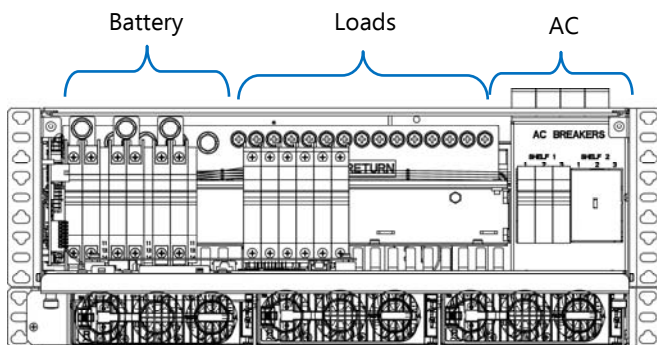

One Shelf System

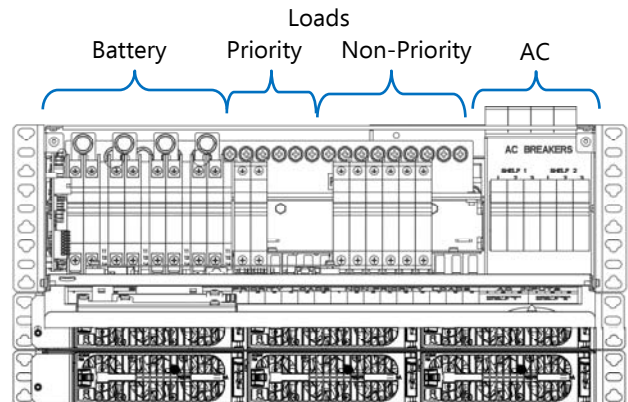

Two Shelf System



Step 5 - Connect Batteries - skip if no batteries installed

Install Battery Breaker Kits - skip if battery breakers are installed or batteries are not present

1. Connect alarm wire to battery breaker (wires provided).
Connect Fastons to breaker terminals.
Terminal 11 - Red
Terminal 12 - Black
2. Mount breaker to DIN rail.
 - a. Verify that breaker is OFF (handle down).
 - b. Fully open the screw connections at breaker bottom - #2 Phillips
 - c. Slide breaker over bus tabs and engage top DIN rail fully
IMPORTANT - Verify top DIN rail engagement.
 - d. Tighten the breaker bottom connection - #2 Phillips.
3. Connect alarm wires to Alarm Card HDR3.
BAT1 Aux + Red
BAT1 Aux - Black
 - a. Run wires to HDR3.
 - b. Cut wires.
 - c. Strip 12 mm (1/2").
 - d. Push release lever, insert wire, release lever, Pull wire to verify.
4. Repeat for additional Battery Breakers, BAT2, etc.

Connect Batteries

1. Connect **Battery Return Cable** to Return Bus.
Battery Return Lug Landings - M8 bolts (lug not provided).
Torque to 14 Nm (120 in-lb) - 1/2" (13 mm) socket.
2. Verify that breaker is OFF (handle down).
CAUTION: Verify battery voltage and polarity with a voltmeter before proceeding.
3. Connect **Battery Cable** to lug adapter (factory assembled to breaker).
Battery Lug Landings - M8 bolts (lug not provided).
Torque to 14 Nm (120 in-lb) - 1/2" (13 mm) socket.

Note: Larger battery breaker may include adaptor bus for two connections.

4. Verify torque of adaptor and bus connection to circuit breaker. Torque to 2-2.3 Nm (20 in-lb) - #2 Phillips.
5. Repeat for additional Battery connections.

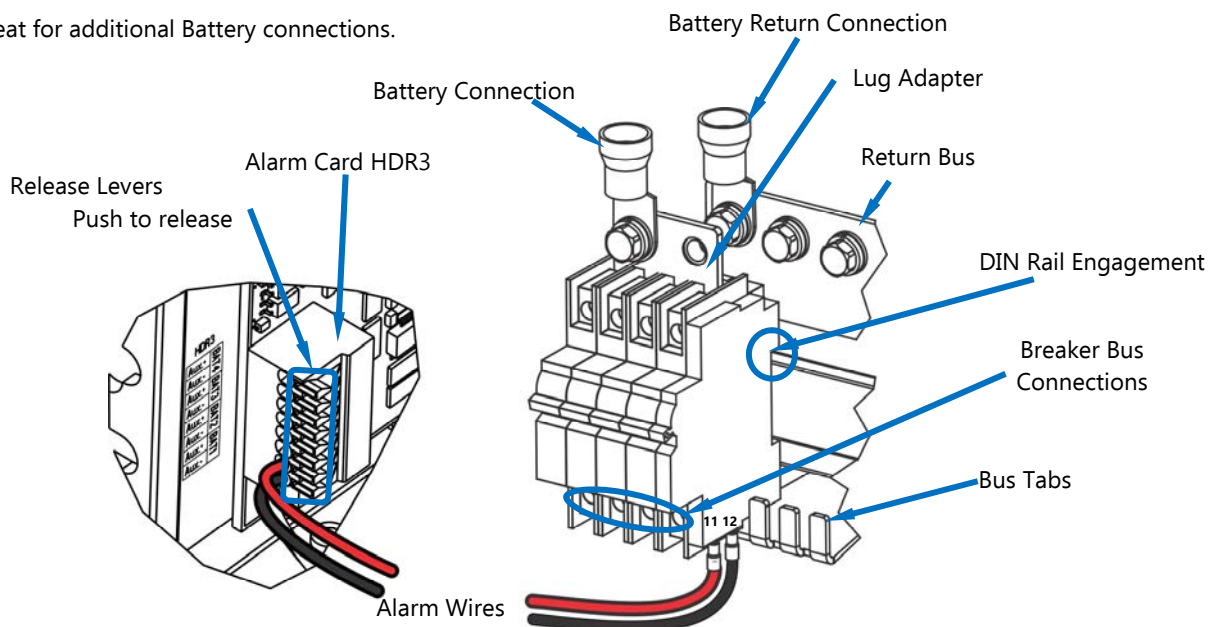

Step 6 - Connect Loads (Outputs)

For system with **LVL**D (two shelf system only), **note positions of priority (critical) versus non-priority (non-critical) loads**. There can be up to 6 priority and 9 non-priority loads.

1. Verify that breaker is OFF (handle down).
2. Mount breaker to DIN rail.
 - a. Fully open the connection at breaker bottom - #2 Phillips.
 - b. Slide breaker over bus tab and fully engage top DIN rail.

IMPORTANT—Verify top DIN rail engagement.

 - a. Tighten the breaker bottom connection - #2 Phillips.
Hold firmly downward and torque to 2-2.3 Nm (20 in-lb).
3. Connect alarm wire to load breaker.

Note: This wire will be secured to the breaker along side the load wire.

 - a. Fully open the screw connection at breaker top - #2 Phillips.
 - b. Choose any wire from the bundle of black wires behind the breakers. Cut wire. Strip 10 mm (3/8"). Insert wire into breaker load connection. Do not tighten the breaker connection.
4. Repeat for additional Load Breakers.

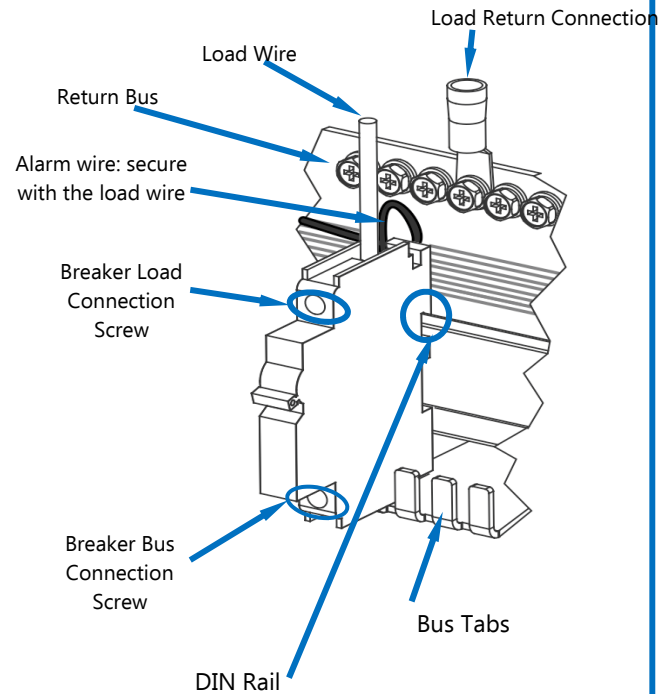

Connect Loads (Outputs)

1. Connect load return wire to the Load Return Bus - M6 lug (not provided).
2. Connect load wire to breaker.
 - a. Strip load wire to 10 mm (3/8").
 - b. Insert load wire into breaker load wire connection alongside the alarm wire.

Step 7 - Label Connections

ID label is in front of the breakers or on the door.
Mark each connected circuit identification on the ID label.

BATTERY				PRIORITY LOADS								NON-PRIORITY LOADS											
1	2	3	4	1	2	3	4	5	6	7	8	1	2	3	4	5	6	7	8	9	10	11	12

ID Label Example

Step 8 - Connect Controller Cables

For additional details, see Steps 11 and 12 for controller information, and Information Sections on battery monitoring and alarm connections.

1. Connect LAN (10Base-T Ethernet) Communication.
2. Connect 1-Wire Battery Monitoring Cables.
3. Connect alarm input and output cables.

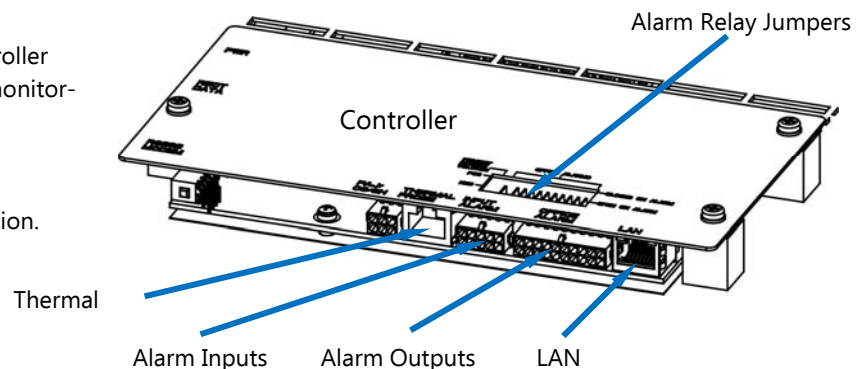

Step 9 - Install Rectifiers

Slide the unit into the power slot approximately 3/4 of the way.



Open the faceplate by sliding the faceplate latch to the left until the faceplate releases and swings outward.



Slide the unit into the slot until it engages with the back of the shelf. Swing the faceplate closed to fully seat the rectifier. Verify the faceplate is latched.

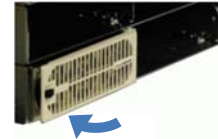

Step 10 - Initial Start Up

Bring Rectifiers Online:

1. Verify the AC and DC connections are complete and secure.
2. Turn on AC input breakers.

Bring Batteries Online:

3. Measure voltage of all battery strings.
4. Set float voltage in controller to lowest measured valid string voltage.
5. Turn on battery breaker of any battery string within 1/2 volt of this lowest measured voltage.
6. Continue by adjusting system voltage up to next measured string not on-line.
Repeat process 5 and 6 until all battery strings are on-line.

Step 11 - Configure Controller

Notes: 1. The *Pulsar Plus Controller Family Product Manual* includes additional information.

2. This system automatically configures Rectifier Parameters.

Craft Port behind door

View and Change Parameters and Alarm Severity

View and change system parameters from the factory defaults via

- a. Controller Display
- b. Craft Port on front of controller using a laptop with EasyView2 software or HyperTerminal.
EasyView2 (GUI) software can be downloaded from www.gecriticalpower.com.
- c. J5 LAN port web pages using a laptop with browser. LAN port Server mode is for local laptop connection. Set the LAN port to Server: With the controller set to Server enter the default IP address 192.168.2.1 (default) in the web browser address field.
Warning: Do not connect J5 LAN port to a network when set to Server. Set the controller to Client or Static before connecting to the network. Static is the factory default setting and the typical setting for most networks.

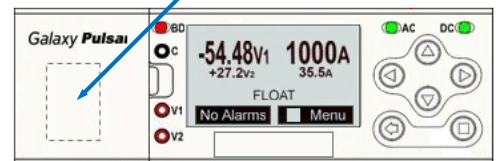

LAN Port - Local / Network

The LAN port is be configured as Local or Network -

controller display menu path: Configuration > Communication Ports > Network Settings > DHCP > mode CLIENT or SERVER

Local (Server): LAN connects to a laptop.

Local (Server) is a temporary setting. When configuration is complete, return LAN port to Network (Client) mode.



Step 11 - Configure Controller (continued)

Alarm Relay Jumpers and 1-Wire Data reference

Jumpers are located on the top of the controller.

Alarm Relay Jumper Factory Defaults are Open On Alarm

1-Wire Reference Factory Default is -48V.

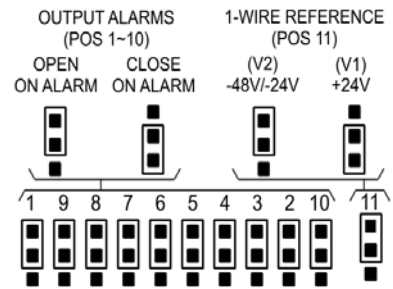

Step 12 - Controller Basic Operation

Controller Alarm Status: The display changes colors; Green = Normal, Amber = Minor Alarm, Red = Critical/Major Alarm

Some alarms may occur during initial installation; example: *thermal probe fail* or *Major/Minor communication fail*.

Clear these alarms: Via Controller Display: follow the menu path; *Menu > Control/Operation > Clear Events* or *Uninstall Equipment*.

Via web pages or EasyView2; Select the *Maintenance* tab > *clear latched events* and *clear missing devices*.

Verify Basic Installation Settings: Date, Time, Battery Type, number of strings and float voltage

Controller Display - *Menu > Configuration > System Settings* and *Menu > Configuration > Batteries*.

Web pages or EasyView2 - *Installation Tab* for Date, Time, Site ID and Site Description.

Settings Tab > Battery Management for Battery Type and number of battery strings installed.

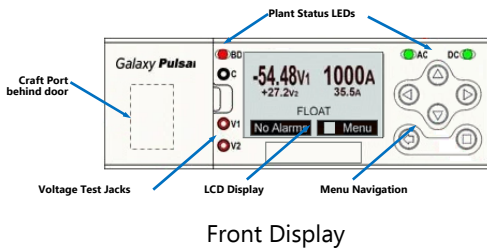

Front Display

Severity	Event	Date	Time
-	no alarms	-	-
-	no warnings	-	-

Web Home Page

Front Display Menu Map

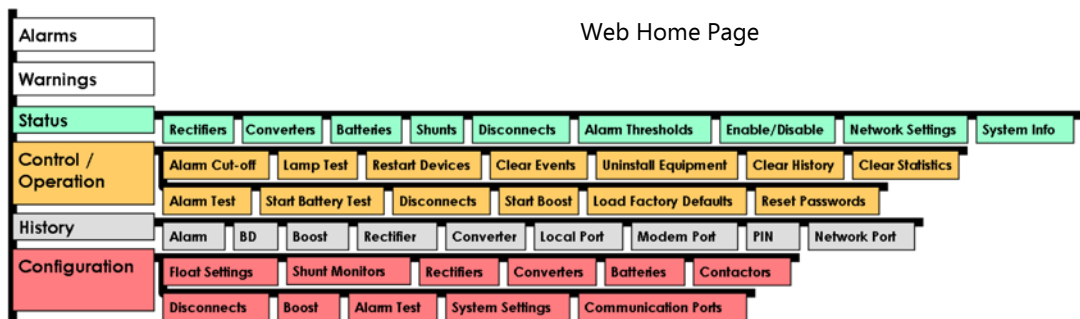

Information: Battery Monitoring Connections

Battery Monitoring is accomplished with a "Daisy Chained" series of probes. The Probes monitor battery temperature and voltage (ES771 required to monitor voltage). Bolt the Probe under the "-" terminal connector hardware; NOT under the connecting lug.

Max per system: Probes - 16, ES771 Modules - 6.

Battery Temperature Measurement

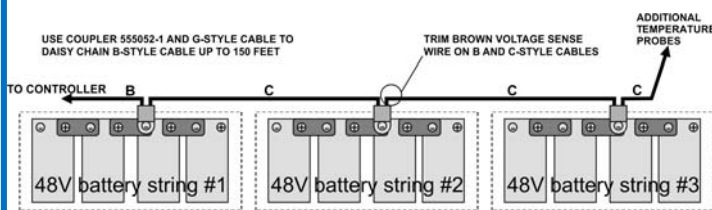

Battery Temperature and Voltage Measurement

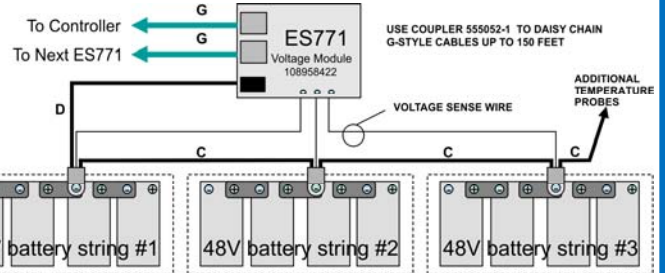

Ordering Codes	Descriptions
CC109142980	QS873A Battery Thermal Probe
150026698	QS873B Ambient Probe
CC848817024	B 10' controller to thermal probe wireset
CC109157434	B 20' controller to thermal probe wireset
CC848822560	C 1' thermal probe to thermal probe wireset
848719803	C 5' thermal probe to thermal probe wireset
850037334	C 20' thermal probe to thermal probe wireset

Ordering Codes	Descriptions
108958422	ES771A Voltage Monitor Card
CC848791517	D 2 ½' ES771A to probe wireset
CC84879290	D 6' ES771A to probe wireset
848719829	D 10' ES771A to probe wireset
CC848791500	G 4' ES771A to ES771A or controller wireset
848652947	G 10' ES771A to ES771A or controller wireset

Information: Alarm Connections

Alarm Outputs

Alarm relays are factory set to Open On Alarm. If Close On Alarm is desired adjust controller alarm jumpers. See diagram in step 8 for the location of the controller alarm jumpers. Alarm output is a 20-pin latching connector. Alarm relays

Standard Controller Alarm Output Defaults		Pin	Color Option 1	Color Option 2
PCR	Power Critical	1	BL	BL
PCR_C	Power Critical_C	11	W	BL/BK
PMJ	Power Major	2	O	O
PMJ_C	Power Major_C	12	W	O/BK
PMN	Power Minor	3	G	G
PMN_C	Power Minor_C	13	W	G/BK
R1	Battery On Discharge	4	BR	W
R1_C	Battery On Discharge_C (BD_C)	14	W	W/BK
R2	Very Low Voltage (VLV)	5	S	BK
R2_C	Very Low Voltage_C (VLV_C)	15	W	BK/W
R3	Fuse Alarm Major (FAJ)	6	BL	BL/W
R3_C	Fuse Alarm Major_C (FAJ_C)	16	R	BL/R
R4	AC Fail (ACF)	7	O	O/R
R4_C	AC Fail_C (ACF_C)	17	R	R
R5	Rectifier Fail (RFA)	8	G	G/W
R5_C	Rectifier Fail_C (RFA_C)	18	R	R/G
R6	Mult. Rectifier Fail (MRFA)	9	BR	W/R
R6_C	Mult. Rectifier Fail_C (MRFA_C)	19	R	R/W
R7	High Voltage (HV)	10	S	BK/R
R7_C	High Voltage_C (HV_C)	20	R	R/BK



Alarm Inputs

Standard Controller Alarm Input Defaults	J3 Pin	Color
Air Con Fail	1	BK
Air Con Fail_Return	8	V
Door Open	2	BR
Door Open_Return	8	V
Aux PMJ Input	3	R
Battery Test/GSTR	4	O
Battery Test_Return	9	S
EPO	5	Y
EPO_Return	10	W
Hi ext. Temp.	6	G
Hi ext. Temp_Return	8	V
Low ext. Temp.	7	BL
Low ext. Temp_Return	8	V

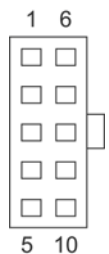

Alarm Output Cables		Alarm Input Cables	
CC848890137	5 ft.	CC848890153	5 ft.
CC109157442	15ft	CC848865980	15 ft.
CC848817635	50 ft	CC848817651	50 ft.
CC848817643	150 ft	CC848817668	150 ft.



Information: Clear Breaker Alarm

The Alarm Card monitors all breakers that were once ON. Breaker Alarms occur while breakers are OFF or TRIPPED.

Clear Breaker Alarm

- Turn the breaker ON
- or
- Press the Alarm Reset button to ignore all breakers that are OFF or TRIPPED, until they

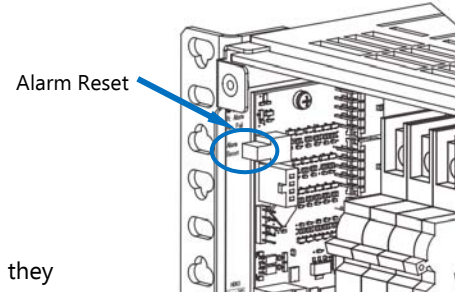

Information: Rectifier Options

Rectifier	Input	Output 48Vdc	Recommended 3-phase AC Breaker (PH-N) "WYE"		
			1-shelf (3 rectifiers) AC Breaker/Wire Gauge	2-shelf (6 rectifiers) AC Breaker/Wire Gauge	
Eco Rectifier blue	NE050ECO48ATEZ	ac 200-277 Vac	50A	20A / 12 AWG	40A / 8 AWG
Rectifier blue	NE075AC48ATEZ	ac 200-277 Vac	75A	30A / 10 AWG	50A / 8 AWG
	NE050AC48ATEZ	ac 208-277 Vac	50A	20A / 12 AWG	40A / 8 AWG

Information: Surge Protectors

Surge Protection Device consists of three RU-320-25 field-replaceable modules protecting Line to Neutral and one RU-180-25 field-replaceable module protecting Neutral to Ground. See page11 for ordering replacement module information.

Replace pluggable modules if RED indicator tab is visible on any of the multiple pole units.
To remove:

1. Verify that you have the correct replacement module.
2. Disconnect power.
3. Pull the pluggable module from the base.
4. Push a new pluggable module into the base. You will hear a "click", indicating that the module is set in place. An insertion "key" built into the unit will help ensure that the module has been correctly selected.

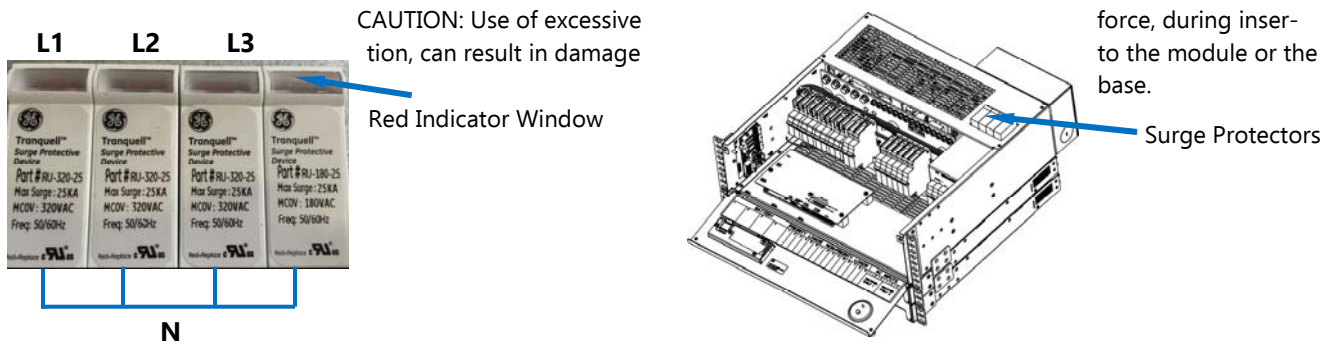

Specifications and Application

- Specifications and ordering information are in the brochures listed in **Reference Documents**.
- Equipment and subassembly ports:
 1. are suitable for connection to intra-building or unexposed wiring or cabling;
 2. can be connected to shielded intra-building cabling grounded at both ends.
- Grounding / Bonding Network – Connect to an Isolated Ground Plane (Isolated Bonding Network) or an Integrated Ground Plane (Mesh-Bonding Network or Common Bonding Network).
- Installation Environment - Install in Network Telecommunication Facilities, OSP, or where NEC applies.
- Battery return may be either Isolated DC return (DC-I) or Common DC return (DC-C).

Reference Documents

These documents are available at www.gecriticalpower.com.

Document	Title
CC848815341	Galaxy Pulsar Plus Product Manual

Safety Statements

- Do not install this equipment over combustible surfaces.
- Rules and Regulations - Follow all national and local rules and regulations when making field connections.
- Compression Connectors
 - U. S. or Canada installations - use Listed/Certified compression connectors to terminate Listed/Certified field-wire conductors.
 - All installations - apply the appropriate connector to the correct size conductor as specified by the connector manufacturer, using only the connector manufacturer's recommended or approved tooling for that connector.
- Electrical Connection Securing: Torque to the values specified on labels or in the product documentation.
- Cable Dress - dress to avoid damage to the conductors and undue stress on the connectors.
- Circuit Breakers and Fuses
 - Use only those specified in the equipment ordering guide.
 - Size as required by the National Electric Code (NEC) and/or local codes.
Safety Tested Limits - Refer to the equipment ratings to assure current does not exceed:
Continuous Load (List 1) - 60% of protector rating
Maximum Load (List 2 - typically end of discharge) - 80% of protector rating.
 - GMT Style Fuses - Use only fuses provided with safety caps.
- Field-wired Conductors - Follow all National Electric Code (NEC) and local rules and regulations.
 - Insulation rating: 90°C minimum; 105°C (minimum) if internal to enclosed equipment cabinets.
 - Size AC field-wired conductors with 75°C ampacity (NEC) equal to or greater than their panel board circuit breaker rating.
 - Size DC field-wired conductors with 90°C ampacity (NEC) equal to or greater than circuit breaker/fuse rating.
- AC and DC input disconnect/protection - Provide accessible devices to remove input power in an emergency.
- Alarm Signals - Provide external current limiting protection. Rating 60V, 0.5A unless otherwise noted.
- Grounding - Connect the equipment chassis directly to ground. In enclosed equipment cabinets connect to the cabinet AC service



Precautions

- Install, service, and operate equipment only by professional, skilled and qualified personnel who have the necessary knowledge and practical experience with electrical equipment and who understand the hazards that can arise when working on this type of equipment.
- Disconnect batteries from outputs and/or follow safety procedures while working on equipment. Batteries may be connected in parallel with the output of the rectifiers. Turning off the rectifiers will not necessarily remove power from the bus.
- Do not disconnect permanent bonding connections unless all power inputs are disconnected.
- Verify that equipment is properly safety earth grounded before connecting power. High leakage currents may be possible.
- Exercise care and follow all safety warnings and practices when servicing this equipment. Hazardous energy and voltages are present in the unit and on the interface cables that can shock or cause serious injury. When equipped with ringer modules, hazardous voltages will be present on the ringer output connectors.
- Use the following precautions in addition to proper job training and safety procedures:
 - Use only properly insulated tools.
 - Remove all metallic objects (key chains, glasses, rings, watches, or other jewelry).
 - Follow Lock Out Tag Out (LOTO) procedures: customer specified, site specific, or general as appropriate. Disconnect all power input before servicing the equipment. Check for multiple power inputs.
 - Wear safety glasses.
 - Follow Personal Protective Equipment requirements: customer specified, site specific, or general as appropriate.
 - Test circuits before touching.
 - Be aware of potential hazards before servicing equipment.
 - Identify exposed hazardous electrical potentials on connectors, wiring, etc.
 - Avoid contacting circuits when removing or replacing covers;
 - Use a personal ESD strap when accessing or removing electronic components.



Spares

For technical support and assistance in ordering spares please contact technical support at the following:

Email: epis.IDCP-techsupport@abb.com

Phone: 1-(877) 546-3243 "Option #2, Option #1)

Replacement Surge Protection Modules

Commcode	Description
RU-320-25	Line to Line Module
RU-180-25	Line to Gnd Module

Notes



Notes

