



Transformer



1M0000000

Catalog Number

9T10A1021

Type QL

15.0 KVA 60 HZ 3 PH 3.7 % IMP

40 C AMB. 150 C RISE 220 C SYSTEM IS-19C

PRIMARY (H) 480 VOLTS (LINE-LINE)
SECONDARY (X) 220 VOLTS (LINE-LINE)
127 VOLTS (LINE-NEUTRAL)

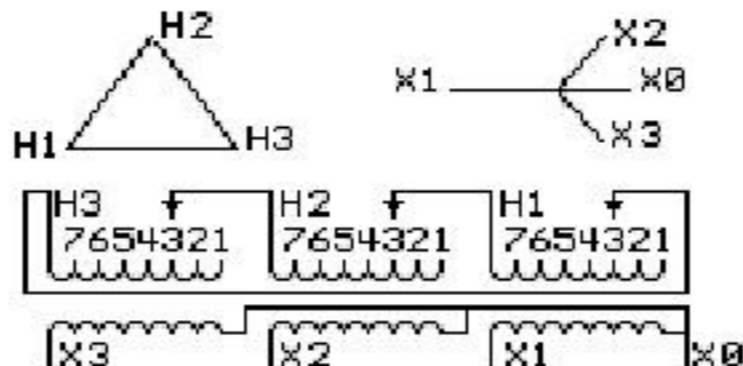

COIL TAP ARRANGEMENT

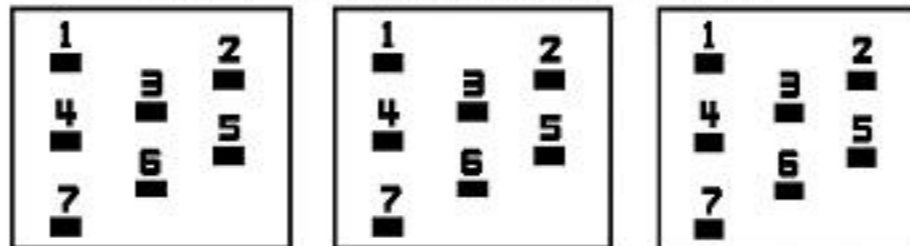

JUMPER CONNECTION	
TAP	VOLTS
1	504
2	491
3	480
4	468
5	455
6	445
7	432

NET WGT
231 LB
104.8 Kg

58591
UX71A
NOG
121015

INSPECTION
&
FINAL TEST
N550!



ENCLOSURE TYPE 2 (IP20). OR RAINPROOF TYPE 3R (IP22) WHEN PROVIDED SHIELD 9T18Y1071G06

BEFORE HANDLING, INSTALLING AND OPERATING, SEE INSTRUCTION 475A667AAP001
ALUMINUM CONDUCTOR PRIMARY: 10 KV BIL SECONDARY: 10 KV BIL Outline: 303B111GEUXP71A

IN ACCORDANCE WITH NEC SECTION 450-9, ALLOW AT LEAST SIX INCHES
CLEARANCE FOR VENTILATION. CHECK ADDITIONAL NEC AND LOCAL CODE

Assembled in Mexico

X3 H3 X2 H2 X1 H1 X0

Note: standard

X0
X1
X2
X3

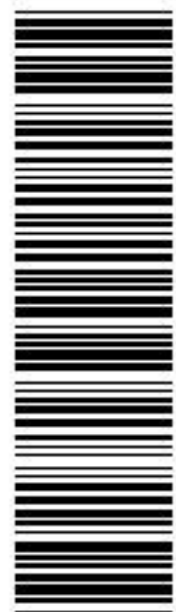

2M0000000

X0
X1
X2
X3



3M0000000