



Transformer



1M0000000

Catalog Number

9T10C1074

Type QL

75.0 KVA 60 HZ 3 PH 5.2 % IMP

40 C AMB. 150 C RISE 220 C SYSTEM IS-19C

PRIMARY (H) 480 VOLTS (LINE-LINE)
SECONDARY (X) 380 VOLTS (LINE-LINE)
219 VOLTS (LINE-NEUTRAL)

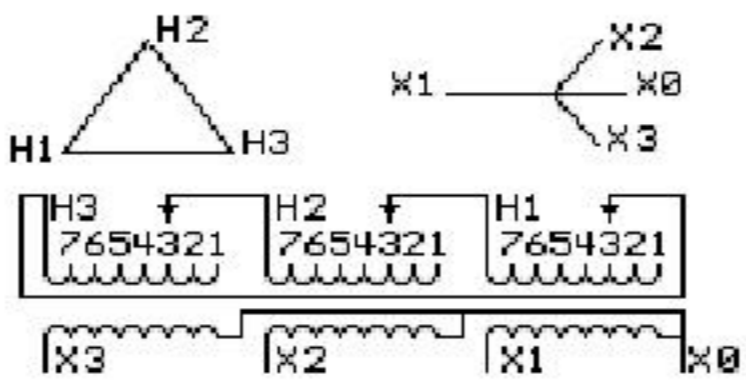

COIL TAP ARRANGEMENT

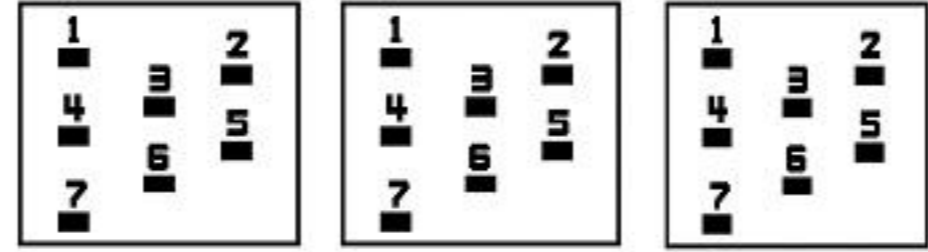

JUMPER CONNECTION TAP	VOLTS
1	505
2	493
3	480
4	468
5	455
6	443
7	431

NET WGT
661 LB
299.8 Kg

58730
UY74C
NOG
121415

INSPECTION & FINAL TEST N551!



ENCLOSURE TYPE 2 (IP20) OR RAINPROOF TYPE 3R (IP22) WHEN PROVIDED SHIELD 9T18Y1074G06

Assembled in Mexico

BEFORE HANDLING, INSTALLING AND OPERATING, SEE INSTRUCTION 475A667AAP001
COPPER CONDUCTOR PRIMARY: 10 KV BIL SECONDARY: 10 KV BIL Outline: 303B111GEUYP74C

IN ACCORDANCE WITH NEC SECTION 450-9, ALLOW AT LEAST SIX INCHES CLEARANCE FOR VENTILATION. CHECK ADDITIONAL NEC AND LOCAL CODE

X3 H3 X2 H2 X1 H1 -

- - - - -

Note: X0 at bottom

X3 H3 X2 H2 X1 H1

X3 H3 X2 H2 X1 H1

X0

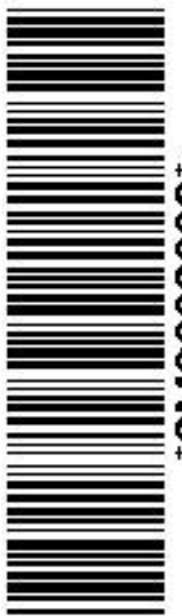

2M0000000

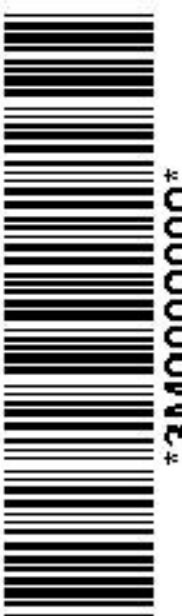

3M0000000