



Transformer



1M0000000

Catalog Number
9T10W1001G61

Type **QL**

15.0 KVA 60 HZ 3 PH 2.3 % IMP

40 C AMB. 80 C RISE 220 C SYSTEM IS-19C

Note: Design is based on 30.00KVA & 115C Rise 4.9% Imp.

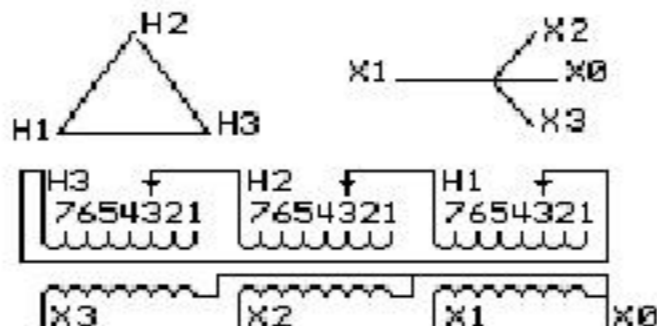

JUMPER CONNECTION	
TAP	VOLTS
1	504
2	492
3	480
4	468
5	456
6	444
7	432

NET WGT
330 LB
149.7 Kg

53508
UX72A

NOG
032816

INSPECTION
&
FINAL TEST
N614!

PRIMARY (H)	480 VOLTS (LINE-LINE)
SECONDARY (X)	208 VOLTS (LINE-LINE)
	120 VOLTS (LINE-NEUTRAL)

COIL TAP ARRANGEMENT

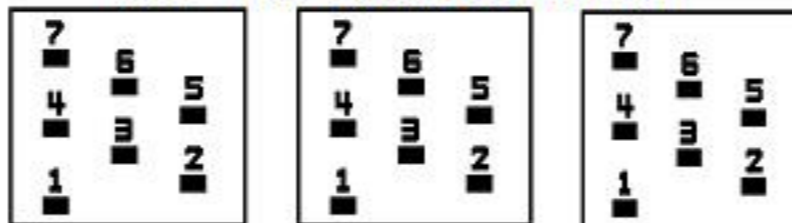

LISTED 769G

ENCLOSURE TYPE 2 (IP20). OR RAINPROOF TYPE 3R (IP22) WHEN PROVIDED SHIELD 9T18W1072G06

Assembled in Mexico

BEFORE HANDLING, INSTALLING AND OPERATING, SEE INSTRUCTION 475A667AAP001
ALUMINUM CONDUCTOR PRIMARY: 10 KV BIL SECONDARY: 10 KV BIL

Outline:
303B111MWUXP72A

X3 H3 X2 H2 X1 H1 X0

**IN ACCORDANCE WITH NEC SECTION 450-9, ALLOW AT LEAST SIX INCHES
CLEARANCE FOR VENTILATION. CHECK ADDITIONAL NEC AND LOCAL CODE**

Note: standard



2M0000000



3M0000000

X3 H3 X2 H2 X1 H1 X0

X3 H3 X2 H2 X1 H1 X0