



# Transformer



\*1M000000\*

Catalog Number

Type QL

9T61B3143G03

45.0 KVA 60 HZ 3 PH 3.8 % IMP

40 C AMB. 150 C RISE 220 C SYSTEM IS-19C

Note: Design is based on 75.00KVA & 150C Rise 6.3% Imp.

PRIMARY (H) 480 VOLTS (LINE-LINE)  
SECONDARY (X) 208 VOLTS (LINE-LINE)  
120 VOLTS (LINE-NEUTRAL)

ELECTROSTATIC GROUND SHIELD IN EACH PHASE

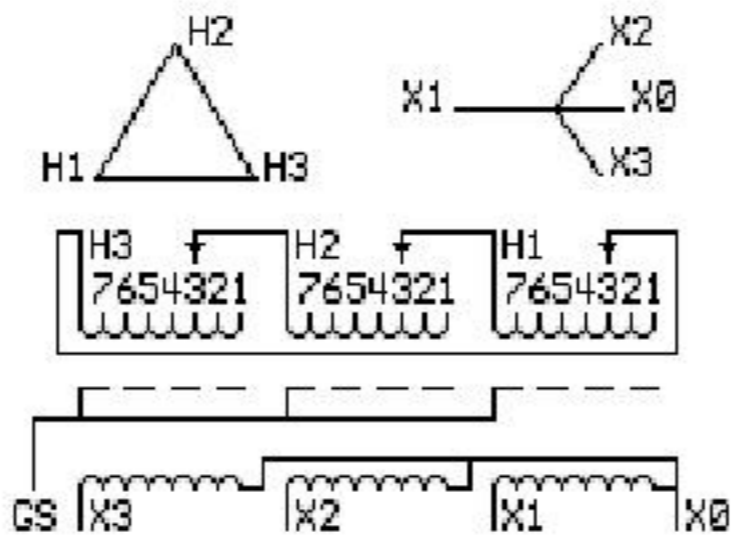

### COIL TAP ARRANGEMENT

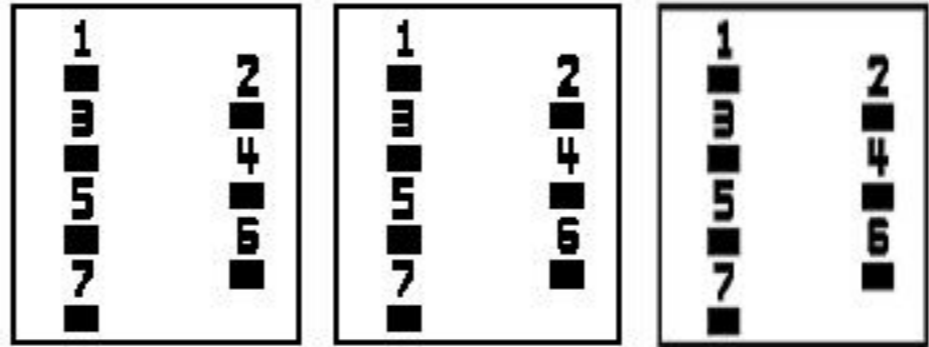

JUMPER CONNECTION	
TAP	VOLTS
1	502
2	491
3	480
4	469
5	455
6	444
7	433

NET WGT  
620 LB  
281.2 Kg

55668  
XU374  
NOG  
102015

INSPECTION  
&  
FINAL TEST  
N543!



LISTED 769G

Assembled in Mexico

ENCLOSURE TYPE 2 (IP30). RAINPROOF TYPE 3R ENCLOSURE (IP32) WHEN PROVIDED SHIELD 9T18Y4317G06

SUITABLE FOR NONSINUSOIDAL CURRENT LOAD WITH K-FACTOR NOT TO EXCEED 13

BEFORE HANDLING, INSTALLING AND OPERATING, SEE INSTRUCTION 475A667AAP001

Outline: 303B401AAP074

ALUMINUM CONDUCTOR PRIMARY: 10 KV BIL SECONDARY: 10 KV BIL

IN ACCORDANCE WITH NEC SECTION 450-9, ALLOW AT LEAST SIX INCHES CLEARANCE FOR VENTILATION. CHECK ADDITIONAL NEC AND LOCAL CODES.

X3 - X2 - X1 - -  
- H3 - H2 - H1

Note: X0 Terminal at the bottom

X1 - - H1  
X2 - - H2  
X3 - - H3  
X1 - - H1  
X2 - - H2  
X3 - - H3

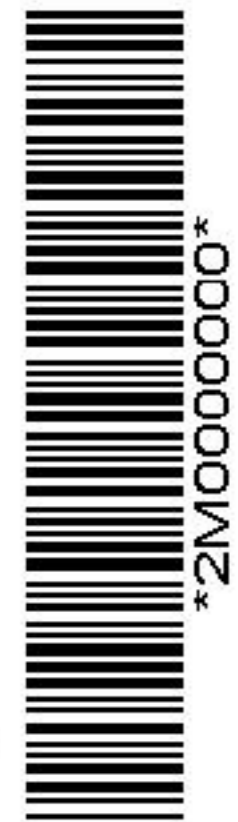

\*2M000000\*

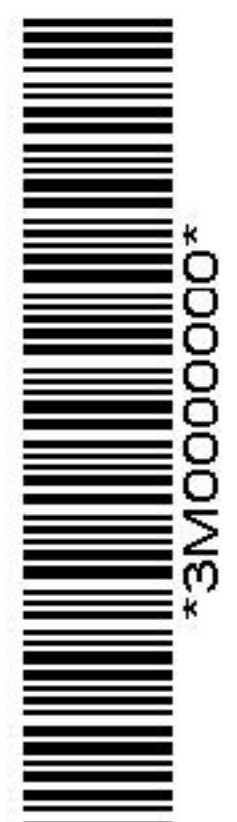

\*3M000000\*

X0