



Transformer



1M000000

Catalog Number

Type QL

9T61B3872G83

30.0 KVA 60 HZ 3 PH 2.3 % IMP

40 C AMB. 80 C RISE 220 C SYSTEM IS-19C

Note: Design is based on 75.00KVA & 150C Rise 6.3% Imp.

PRIMARY (H) 480 VOLTS (LINE-LINE)
SECONDARY (X) 208 VOLTS (LINE-LINE)
120 VOLTS (LINE-NEUTRAL)

ELECTROSTATIC GROUND SHIELD IN EACH PHASE

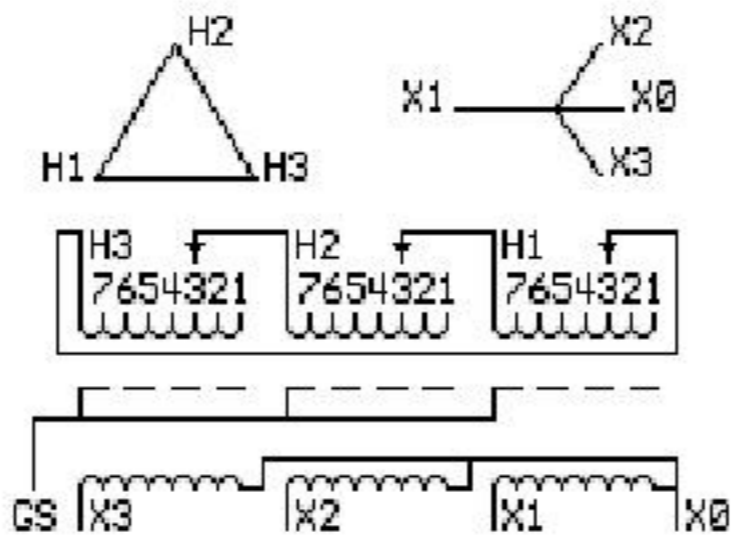

COIL TAP ARRANGEMENT

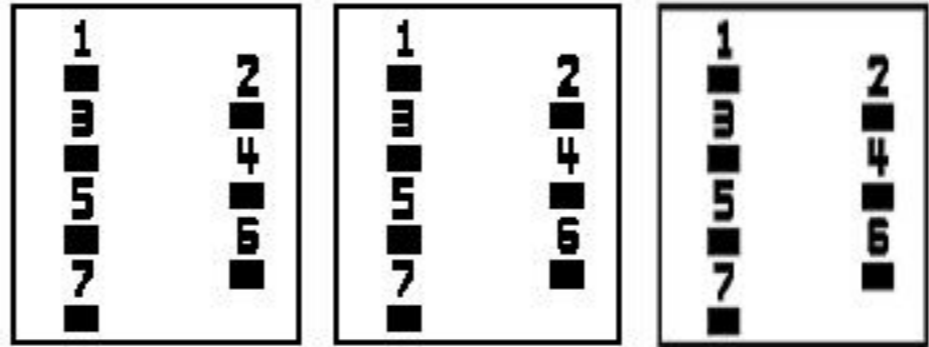

JUMPER CONNECTION	
TAP	VOLTS
1	502
2	491
3	480
4	469
5	455
6	444
7	433

NET WGT
620 LB
281.2 Kg

55668
XU374
NOG
102015

INSPECTION
&
FINAL TEST
N543!



LISTED 769G

Assembled in Mexico

ENCLOSURE TYPE 2 (IP30). RAINPROOF TYPE 3R ENCLOSURE (IP32) WHEN PROVIDED SHIELD 9T18Y4317G06
SUITABLE FOR NONSINUSOIDAL CURRENT LOAD WITH K-FACTOR NOT TO EXCEED 13
BEFORE HANDLING, INSTALLING AND OPERATING, SEE INSTRUCTION 475A667AAP001 Outline: 303B401AAP074
ALUMINUM CONDUCTOR PRIMARY: 10 KV BIL SECONDARY: 10 KV BIL

IN ACCORDANCE WITH NEC SECTION 450-9, ALLOW AT LEAST SIX INCHES CLEARANCE FOR VENTILATION. CHECK ADDITIONAL NEC AND LOCAL CODES.

X3 - X2 - X1 - -
- H3 - H2 - H1

Note: X0 Terminal at the bottom

X1 - - H1
X2 - - H2
X3 - - H3
X1 - - H1
X2 - - H2
X3 - - H3

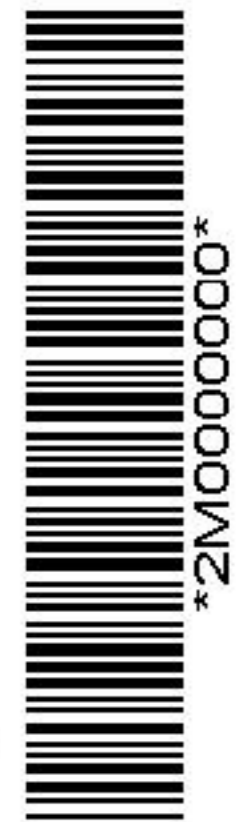

2M000000

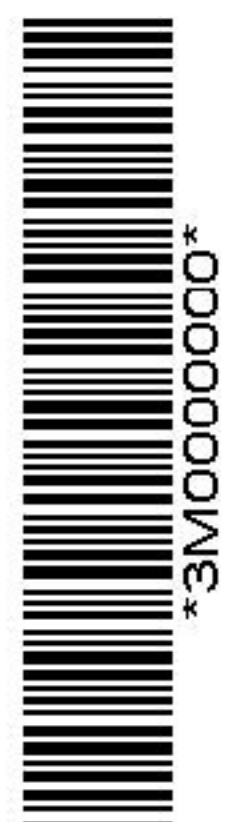

3M000000

X0