



Transformer



1M000000

Catalog Number
9T61C9874G83

Type **QL**

75.0 KVA 60 HZ 3 PH 2.5 % IMP

40 C AMB. 80 C RISE 220 C SYSTEM IS-19C

Note: Design is based on 150.0KVA & 150C Rise 5.5% Imp.

PRIMARY (H) 480 VOLTS (LINE-LINE)
SECONDARY (X) 208 VOLTS (LINE-LINE)
120 VOLTS (LINE-NEUTRAL)

ELECTROSTATIC GROUND SHIELD IN EACH PHASE

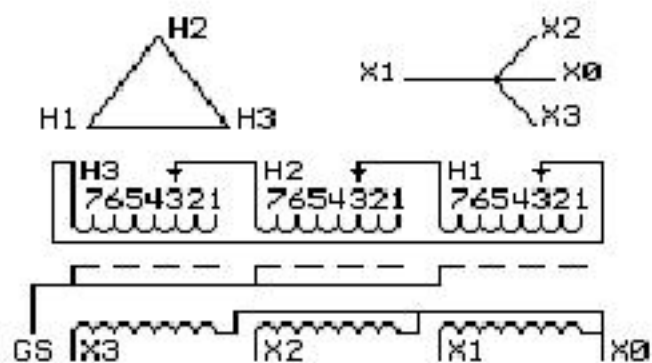

COIL TAP ARRANGEMENT

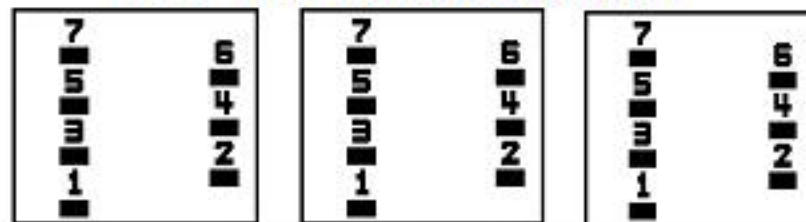

JUMPER CONNECTION	
TAP	VOLTS
1	506
2	491
3	480
4	470
5	454
6	444
7	433

NET WGT
1190 LB
539.8 Kg

43001
XV376

NOG

072715

INSPECTION
&
FINAL TEST
N531!



LISTED 769G

Assembled in Mexico

X3 - X2 - X1 - -
- H3 - H2 - H1

Note: X0 Terminal at the bottom

ENCLOSURE TYPE 2 (IP30). RAINPROOF TYPE 3R ENCLOSURE (IP32) WHEN PROVIDED SHIELD 9T18Y4317G07

SUITABLE FOR NONSINUSOIDAL CURRENT LOAD WITH K-FACTOR NOT TO EXCEED 13

BEFORE HANDLING, INSTALLING AND OPERATING, SEE INSTRUCTION 475A667AAP001

Outline: 303B401AAP076

COPPER CONDUCTOR

PRIMARY: 10 KV BIL

SECONDARY: 10 KV BIL

IN ACCORDANCE WITH NEC SECTION 450-9, ALLOW AT LEAST SIX INCHES
CLEARANCE FOR VENTILATION. CHECK ADDITIONAL NEC AND LOCAL CODES.

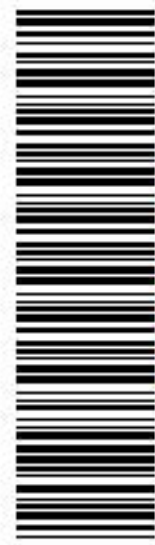

2M000000



3M000000

X3 - X2 - X1 - -
- H3 - H2 - H1
X3 - X2 - X1 - -
- H3 - H2 - H1

X0