



# Transformer



\*1M000000\*

Catalog Number

TYPE QL

## 9T61W3873G93

### 45.0 KVA 60 HZ 3 PH 3.5 % IMP

40 C AMB. 80 C RISE 220 C SYSTEM IS-19C

Note: Design is based on 75.00KVA & 150C Rise 6.3% Imp.

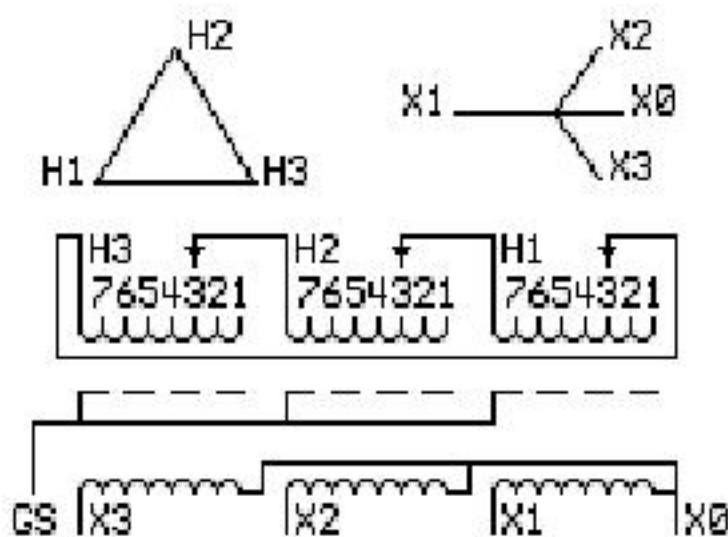

JUMPER CONNECTION	
TAP	VOLTS
1	502
2	491
3	480
4	469
5	455
6	444
7	433

NET WGT

620 LB

281.2 Kg

9T40G0007

55668

XW374

NOG

072915

INSPECTION

&

FINAL TEST

N531!

PRIMARY (H) 480 VOLTS (LINE-LINE)  
 SECONDARY (X) 208 VOLTS (LINE-LINE)  
 120 VOLTS (LINE-NEUTRAL)

### COIL TAP ARRANGEMENT

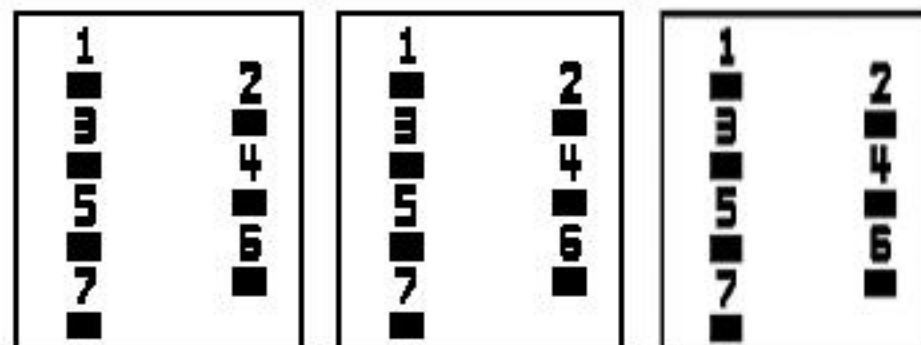

LISTED 769G

ELECTROSTATIC GROUND SHIELD IN EACH PHASE

ENCLOSURE TYPE 2 (IP30). RAINPROOF TYPE 3R ENCLOSURE (IP32) WHEN PROVIDED SHIELD 9T18W4317G06

SUITABLE FOR NONSINUSOIDAL CURRENT LOAD WITH K-FACTOR NOT TO EXCEED 13

BEFORE HANDLING, INSTALLING AND OPERATING, SEE INSTRUCTION 475A667AAP001

Outline: 303B401MWP074

ALUMINUM CONDUCTOR

PRIMARY: 10 KV BIL

SECONDARY: 10 KV BIL

IN ACCORDANCE WITH NEC SECTION 450-9, ALLOW AT LEAST SIX INCHES CLEARANCE FOR VENTILATION. CHECK ADDITIONAL NEC AND LOCAL CODES.

Assembled in Mexico

X3 - X2 - X1 - -  
 - H3 - H2 - H1

Note: X0 Terminal at the bottom

X1 - - H1  
 X2 - - H2  
 X3 - - H3  
 X1 - - H1  
 X2 - - H2  
 X3 - - H3

# X0



\*2M000000\*



\*3M000000\*