



Transformer



1M000000

X0

X0

Catalog Number
9T64C9870G53

Type **QL**

11.0 KVA 60 HZ 3 PH 4.3 % IMP

40 C AMB. 150 C RISE 220 C SYSTEM IS-19C

Note: Design is based on 15.00KVA & 150C Rise 5.9% Imp.

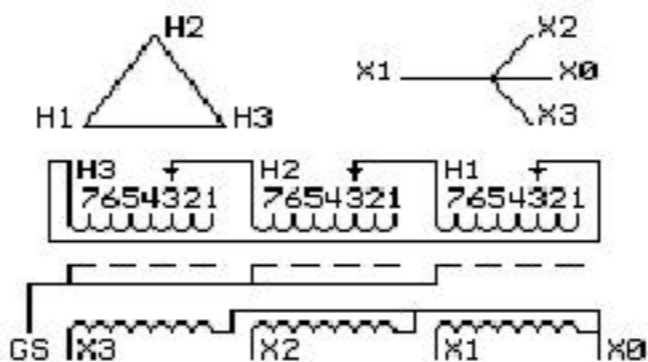

JUMPER CONNECTION	
TAP	VOLTS
1	505
2	492
3	480
4	467
5	456
6	445
7	432

NET WGT
250 LB
113.4 Kg

32271
XV371
NOG
071615

INSPECTION
&
FINAL TEST
N529!

PRIMARY (H) 480 VOLTS (LINE-LINE)
 SECONDARY (X) 208 VOLTS (LINE-LINE)
 120 VOLTS (LINE-NEUTRAL)

COIL TAP ARRANGEMENT

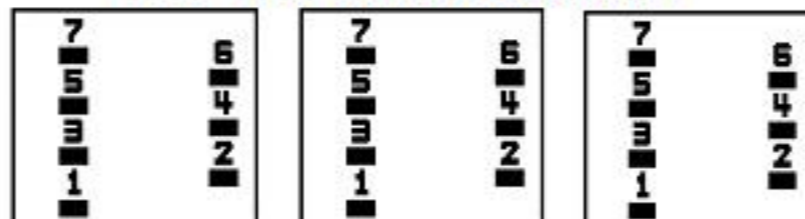

LISTED 769G

ELECTROSTATIC GROUND SHIELD IN EACH PHASE

ENCLOSURE TYPE 2 (IP30). RAINPROOF TYPE 3R ENCLOSURE (IP32) WHEN PROVIDED SHIELD 9T18Y4317G11

SUITABLE FOR NONSINUSOIDAL CURRENT LOAD WITH K-FACTOR NOT TO EXCEED 4

BEFORE HANDLING, INSTALLING AND OPERATING, SEE INSTRUCTION 475A667AAP001

Outline: 303B401AAP071

COPPER CONDUCTOR

PRIMARY: 10 KV BIL

SECONDARY: 10 KV BIL

IN ACCORDANCE WITH NEC SECTION 450-9, ALLOW AT LEAST SIX INCHES
CLEARANCE FOR VENTILATION. CHECK ADDITIONAL NEC AND LOCAL CODES.

Assembled in Mexico

X3 - X2 - X1 - X0
 - H3 - H2 - H1

Note: Standard



2M000000



3M000000