



# Transformer



\*1M000000\*

Catalog Number  
**9T64C9872G83**

Type **QL**

**30.0 KVA 60 HZ 3 PH 3.2 % IMP**

40 C AMB. 80 C RISE 220 C SYSTEM IS-19C

Note: Design is based on 45.00KVA & 150C Rise 5.5% Imp.

PRIMARY (H) 480 VOLTS (LINE-LINE)  
SECONDARY (X) 208 VOLTS (LINE-LINE)  
120 VOLTS (LINE-NEUTRAL)

ELECTROSTATIC GROUND SHIELD IN EACH PHASE

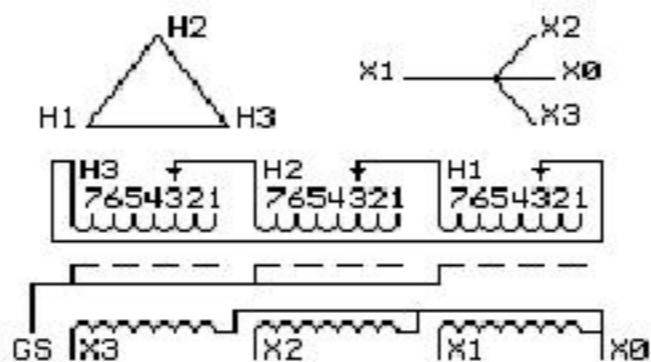

### COIL TAP ARRANGEMENT

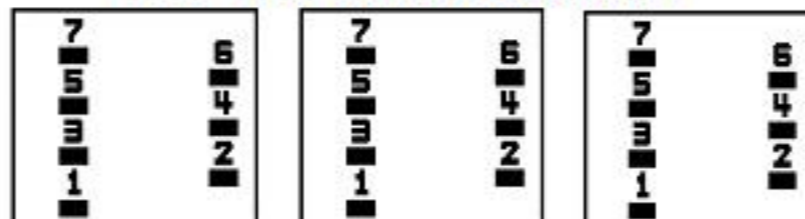

JUMPER CONNECTION	
TAP	VOLTS
1	503
2	492
3	480
4	469
5	455
6	443
7	432

NET WGT  
490 LB  
222.3 Kg

55631  
XV373  
NOG  
081815

INSPECTION  
&  
FINAL TEST  
N534!



LISTED 769G

Assembled in Mexico

X3 - X2 - X1 - -  
- H3 - H2 - H1

Note: X0 Terminal at the bottom

ENCLOSURE TYPE 2 (IP30). RAINPROOF TYPE 3R ENCLOSURE (IP32) WHEN PROVIDED SHIELD 9T18Y4317G05

SUITABLE FOR NONSINUSOIDAL CURRENT LOAD WITH K-FACTOR NOT TO EXCEED 4

BEFORE HANDLING, INSTALLING AND OPERATING, SEE INSTRUCTION 475A667AAP001

Outline: 303B401AAP073

COPPER CONDUCTOR

PRIMARY: 10 KV BIL

SECONDARY: 10 KV BIL

IN ACCORDANCE WITH NEC SECTION 450-9, ALLOW AT LEAST SIX INCHES  
CLEARANCE FOR VENTILATION. CHECK ADDITIONAL NEC AND LOCAL CODES.

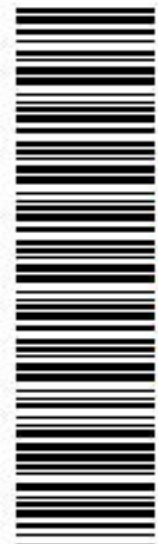

\*2M000000\*



\*3M000000\*

X3 - X2 - X1 - -  
- H3 - H2 - H1  
X3 - X2 - X1 - -  
- H3 - H2 - H1  
X0