



# K Factor Transformer



\*1M000000\*

Catalog Number TYPE QL

## 9T83B3452G13

30.0 KVA 60 HZ 3 PH 3.4 % IMP

40 C AMB. 115 C RISE 220 C SYSTEM IS-19C

Note: Design is based on 45.00KVA & 150C Rise 5.4% Imp.

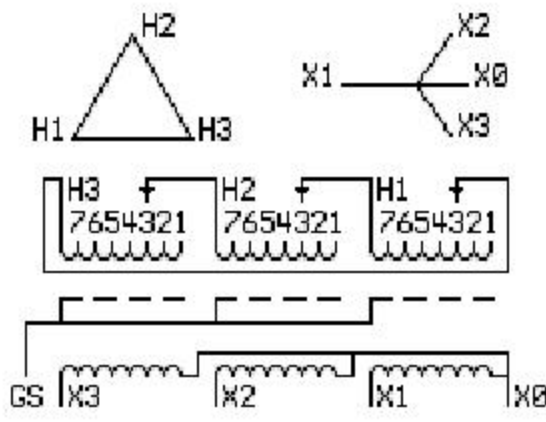

JUMPER CONNECTION TAP	VOLTS
1	502
2	491
3	480
4	470
5	465
6	446
7	435

NET WGT  
430 LB  
195.0 Kg  
9T83B5873G0  
16045  
EE73  
NOG  
111411

INSPECTION & FINAL TEST  
N147!

PRIMARY (H) 480 VOLTS (LINE-LINE)  
SECONDARY (X) 208 VOLTS (LINE-LINE)  
120 VOLTS (LINE-NEUTRAL)

### COIL TAP ARRANGEMENT

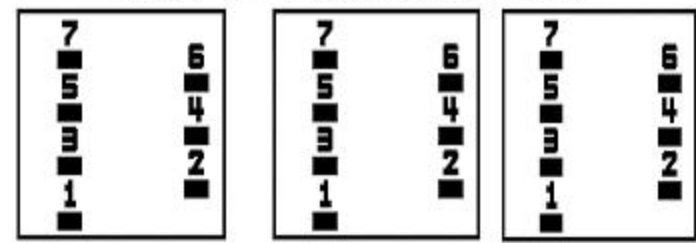

LISTED 769G

ELECTROSTATIC GROUND SHIELD IN EACH PHASE

ENCLOSURE TYPE 2 (IP30). RAINPROOF TYPE 3R ENCLOSURE (IP32) WHEN PROVIDED SHIELD 9T18Y4317G05

SUITABLE FOR NONSINUSOIDAL CURRENT LOAD WITH K-FACTOR NOT TO EXCEED 30  
BEFORE HANDLING, INSTALLING AND OPERATING, SEE INSTRUCTION 475A667AAP001 Outline: 303B401AAP073  
ALUMINUM CONDUCTOR PRIMARY: 10 KV BIL SECONDARY: 10 KV BIL

IN ACCORDANCE WITH NEC SECTION 450-9, ALLOW AT LEAST SIX INCHES CLEARANCE FOR VENTILATION. CHECK ADDITIONAL NEC AND LOCAL CODES.

Assembled in Mexico

X3 - X2 - X1 - -  
- H3 - H2 - H1

Note: X0 Terminal at the bottom



\*2M000000\*

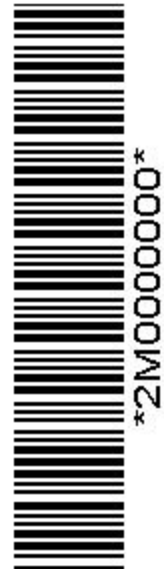

\*2M000000\*

X3 - X2 - X1 - -  
- H3 - H2 - H1  
X3 - X2 - X1 - -  
- H3 - H2 - H1  
X0