



Transformer



M0000000

Catalog Number
9T83B4002G29

Type QL

27.0 KVA 60 HZ 3 PH 5.5 % IMP

40 C AMB. 150 C RISE 220 C SYSTEM IS-19C

PRIMARY (H) 230 VOLTS (LINE-LINE)
SECONDARY (X) 230 VOLTS (LINE-LINE)
133 VOLTS (LINE-NEUTRAL)

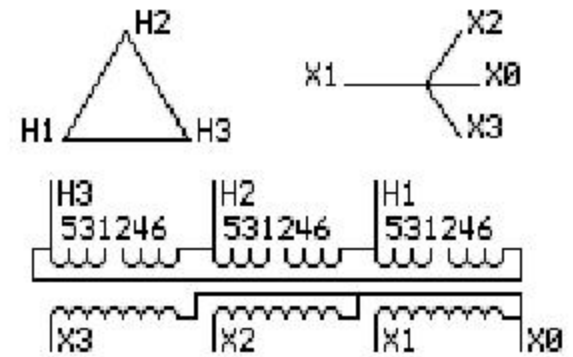

COIL TAP ARRANGEMENT

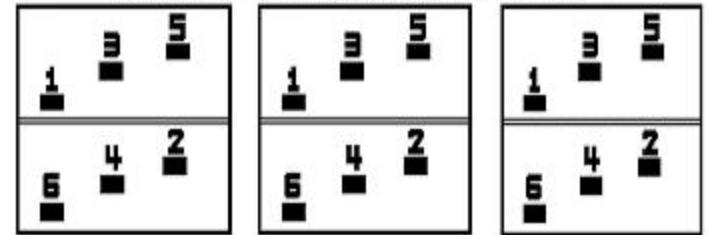

JUMPER CONNECTION

TAP	VOLTS
1-2	242
3-4	230
5-6	218

NET WGT
334 LB
151.5 Kg
9T83B4002G29
25239
W372
NOG
013013

INSPECTION & FINAL TEST N305!



LISTED 769G

Assembled in Mexico

ENCLOSURE TYPE 2 (IP30). RAINPROOF TYPE 3R ENCLOSURE (IP32) WHEN PROVIDED SHIELD 9T18Y4317G05

BEFORE HANDLING, INSTALLING AND OPERATING, SEE INSTRUCTION 475A667AAP001 Outline: 303B401AAP072
ALUMINUM CONDUCTOR PRIMARY: 10 KV BIL SECONDARY: 10 KV BIL

IN ACCORDANCE WITH NEC SECTION 450-9, ALLOW AT LEAST SIX INCHES CLEARANCE FOR VENTILATION. CHECK ADDITIONAL NEC AND LOCAL CODES.

X3 - X2 - X1 - -
- H3 - H2 - H1

Note: X0 Terminal at the bottom

X3 - X2 - X1 - -
- H3 - H2 - H1
X3 - X2 - X1 - -
- H3 - H2 - H1
X0



M0000000



M0000000