



# Transformer



\*1M000000\*

Catalog Number

Type QL

9Q3A045AAAF00A2T00

9T83B5573

45.0 KVA 60 HZ 3 PH 6.6 % IMP

40 C AMB. 150 C RISE 220 C SYSTEM IS-19C

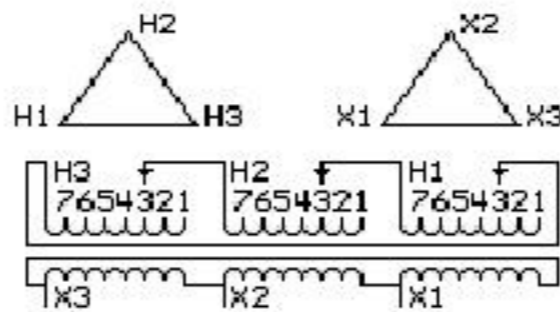

JUMPER CONNECTION	
TAP	VOLTS
1	504
2	492
3	480
4	469
5	457
6	445
7	431

NET WGT  
415 LB  
188.2 Kg

53470  
XV373  
NOG  
071515

INSPECTION  
&  
FINAL TEST  
N529!

PRIMARY (H) 480 VOLTS (LINE-LINE)  
SECONDARY (X) 230 VOLTS (LINE-LINE)

### COIL TAP ARRANGEMENT

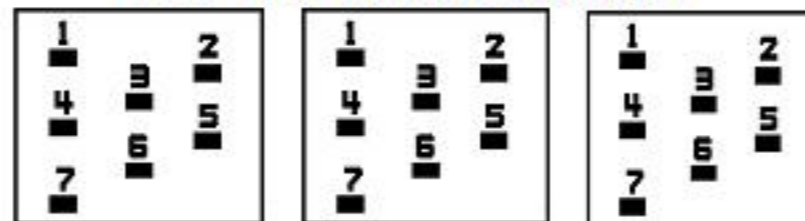

ENCLOSURE TYPE 2 (IP30). RAINPROOF TYPE 3R ENCLOSURE (IP32) WHEN PROVIDED SHIELD 9T18Y4317G05

Assembled in Mexico

BEFORE HANDLING, INSTALLING AND OPERATING, SEE INSTRUCTION 475A667AAP001  
ALUMINUM CONDUCTOR PRIMARY: 10 KV BIL SECONDARY: 10 KV BIL

Outline: 303B401AAP073

IN ACCORDANCE WITH NEC SECTION 450-9, ALLOW AT LEAST SIX INCHES  
CLEARANCE FOR VENTILATION. CHECK ADDITIONAL NEC AND LOCAL CODES.

X3 - X2 - X1 - -  
- H3 - H2 - H1

Note: Standard

X1 - -  
X2 - - H2 - H1  
X3 - - H3 - H2 - H1



\*2M000000\*



\*3M000000\*