



Transformer



1M000000

Catalog Number

Type QL

9T83B5601

15.0 KVA 60 HZ 3 PH 6.8 % IMP

40 C AMB. 150 C RISE 220 C SYSTEM IS-19C

PRIMARY (X) 220 VOLTS (LINE-LINE)
SECONDARY (H) 440 VOLTS (LINE-LINE)
254 VOLTS (LINE-NEUTRAL)

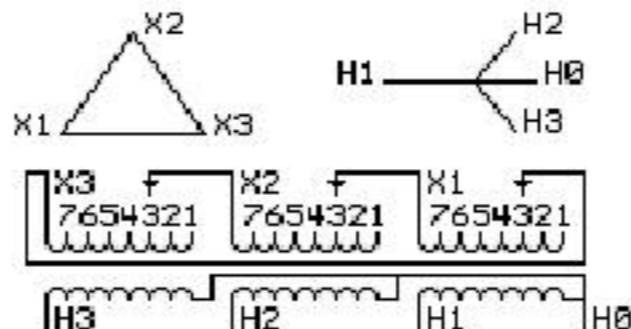

JUMPER CONNECTION	
TAP	VOLTS
1	231
2	226
3	220
4	215
5	210
6	204
7	199

NET WGT
240 LB
108.9 Kg

54517
XV371
NOG
071615

INSPECTION
&
FINAL TEST
N529!

COIL TAP ARRANGEMENT

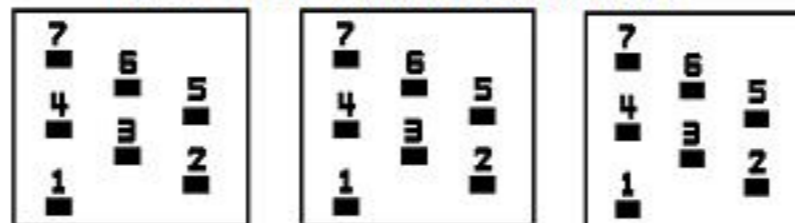

LISTED 769G

ENCLOSURE TYPE 2 (IP30). RAINPROOF TYPE 3R ENCLOSURE (IP32) WHEN PROVIDED SHIELD 9T18Y4317G11

Assembled in Mexico

BEFORE HANDLING, INSTALLING AND OPERATING, SEE INSTRUCTION 475A667AAP001
ALUMINUM CONDUCTOR PRIMARY: 10 KV BIL SECONDARY: 10 KV BIL

Outline: 303B401AAP071

IN ACCORDANCE WITH NEC SECTION 450-9, ALLOW AT LEAST SIX INCHES
CLEARANCE FOR VENTILATION. CHECK ADDITIONAL NEC AND LOCAL CODES.

H3 - H2 - H1 - -
- X3 - X2 - X1

Note:

H3 - H2 - H1 -
- X3 - X2 - X1
H3 - H2 - H1 -
- X3 - X2 - X1

H0



2M000000



3M000000