



Transformer



1M000000

No. Catalogue **9T83K4006G27** Type **QL**

63.0 KVA 60 HZ 3 PH 4.8 % IMP

40 C AMB. Élev. Temp 150 Class d'isol. 220 C IS-19C

PRIMARY (H) 575 VOLTS (LINE-LINE)
SECONDARY (X) 230 VOLTS (LINE-LINE)
133 VOLTS (LINE-NEUTRAL)

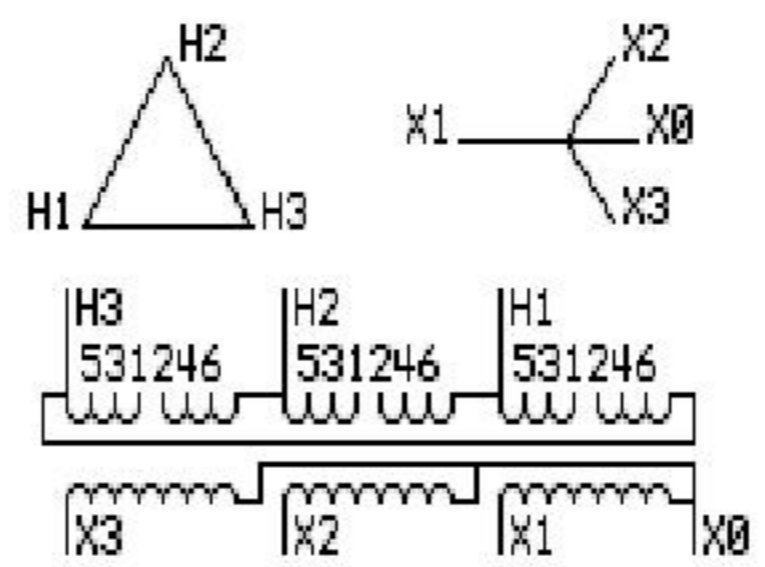

COIL TAP ARRANGEMENT

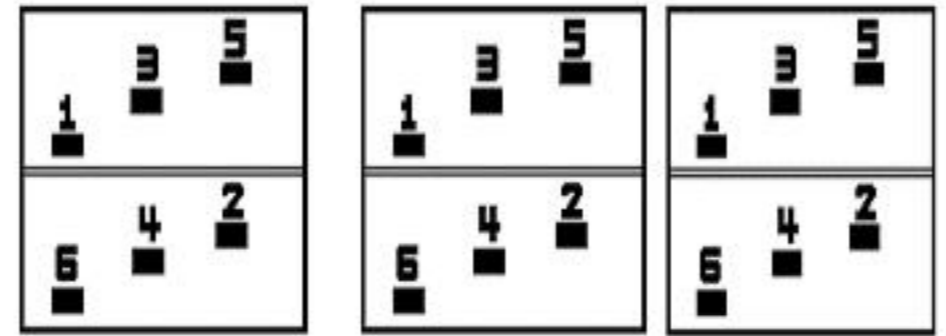

JUMPER CONNECTION	
TAP	VOLTS
1-2	605
3-4	575
5-6	546

POIDS NET
620 LB
281.2 Kg

55803
XU374
NOG
072915

INSPECTION &
ESSAIS
FINAUX
N531!



Assembled in Mexico

BOÎTIER TYPE 2(IP30) À L'ÉPREUVE DES ÉGOUTTEMENTS. BOÎTIER TYPE 3R (IP32). À L'ÉPREUVE
DES INTEMPÉRIES LORSQUE FOURNI AVEC ÉCRAN
VOIR INSTRUCTION 475A667AAP001 AVANT LA MANIPULATION, L'INSTALLATION OU L'OPÉRATION
ALUMINUM CONDUCTOR PRIMARY: 10 KV BIL SECONDARY: 10 KV BIL

9T18Y4317G06

Outline: 303B401CAP074

LAISSER UNE ESPACE DE 6 POUCES POUR ASSURER UNE VENTILATION ADÉQUATE.
VÉRIFIER LES CONSIGNES DU CODE ÉLECTRIQUE CANADIEN OU AUTRES CODES.

X3 - X2 - X1 - -
- H3 - H2 - H1

Note: X0 Terminal at the bottom

X1 - - H1
X2 - - H2
X3 - - H3
X1 - - H1
X2 - - H2
X3 - - H3



2M000000

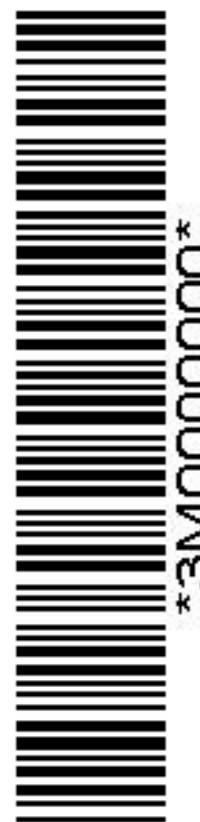

3M000000