



Transformer



1M000000

Catalog Number

TYPE QL

9T83W3464G13

75.0 KVA 60 HZ 3 PH 3.7 % IMP

40 C AMB. 115 C RISE 220 C SYSTEM IS-19C

Note: Design is based on 112.5KVA & 150C Rise 6.4% Imp.

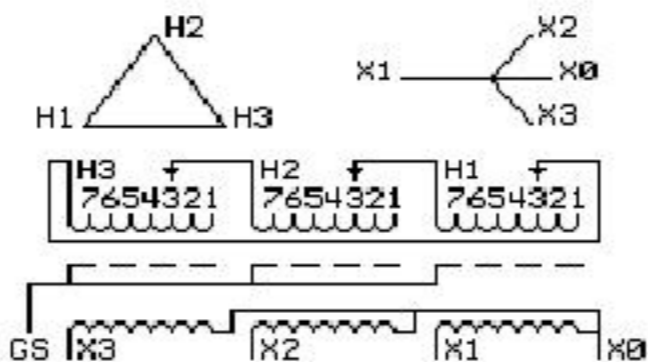

JUMPER CONNECTION	
TAP	VOLTS
1	504
2	490
3	480
4	466
5	456
6	442
7	432

NET WGT
765 LB
347.0 Kg
9T40G00C7
55092
XV375
NOG
072115

INSPECTION
&
FINAL TEST
N530!

PRIMARY (H) 480 VOLTS (LINE-LINE)
SECONDARY (X) 208 VOLTS (LINE-LINE)
 120 VOLTS (LINE-NEUTRAL)

COIL TAP ARRANGEMENT

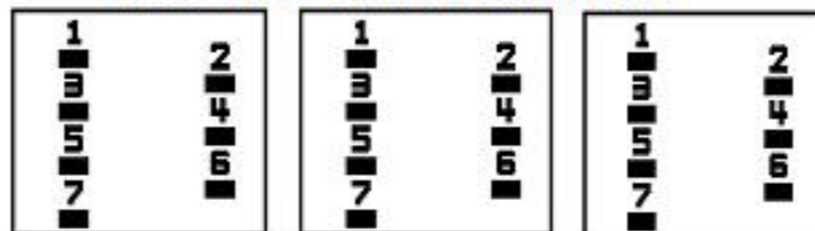

ELECTROSTATIC GROUND SHIELD IN EACH PHASE

ENCLOSURE TYPE 2 (IP30). RAINPROOF TYPE 3R ENCLOSURE (IP32) WHEN PROVIDED SHIELD 9T18W4317G06

SUITABLE FOR NONSINUSOIDAL CURRENT LOAD WITH K-FACTOR NOT TO EXCEED 4

BEFORE HANDLING, INSTALLING AND OPERATING, SEE INSTRUCTION 475A667AAP001

Outline: 303B401MWP075

ALUMINUM CONDUCTOR PRIMARY: 10 KV BIL SECONDARY: 10 KV BIL

IN ACCORDANCE WITH NEC SECTION 450-9, ALLOW AT LEAST SIX INCHES CLEARANCE FOR VENTILATION. CHECK ADDITIONAL NEC AND LOCAL CODES.

Assembled in Mexico

X3 - X2 - X1 - -
- H3 - H2 - H1

Note: X0 Terminal at the bottom

X3 - X2 - X1 -
- H3 - H2 - H1
X3 - X2 - X1 -
- H3 - H2 - H1
X0



2M000000

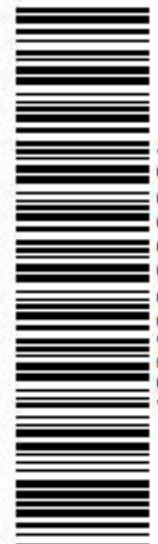

3M000000