



Transformer



1M000000

Catalog Number

TYPE QL

9T83W9872G83

30.0 KVA 60 HZ 3 PH 3.2 % IMP

40 C AMB. 80 C RISE 220 C SYSTEM IS-19C

Note: Design is based on 45.00KVA & 150C Rise 5.5% Imp.

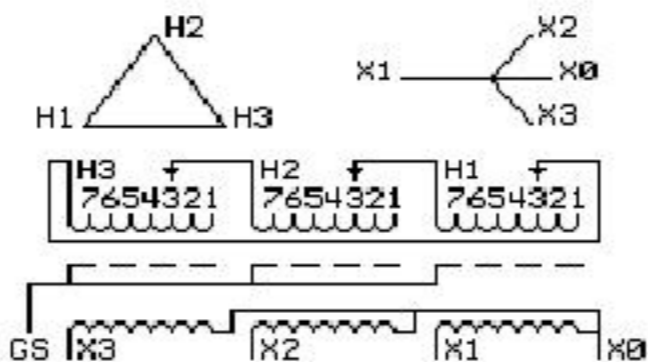

JUMPER CONNECTION	
TAP	VOLTS
1	503
2	492
3	480
4	469
5	455
6	443
7	432

NET WGT
490 LB
222.3 Kg
9T40G00C7
55631
XV373
NOG
081815

INSPECTION
&
FINAL TEST
N534!

PRIMARY (H) 480 VOLTS (LINE-LINE)
SECONDARY (X) 208 VOLTS (LINE-LINE)
120 VOLTS (LINE-NEUTRAL)

COIL TAP ARRANGEMENT

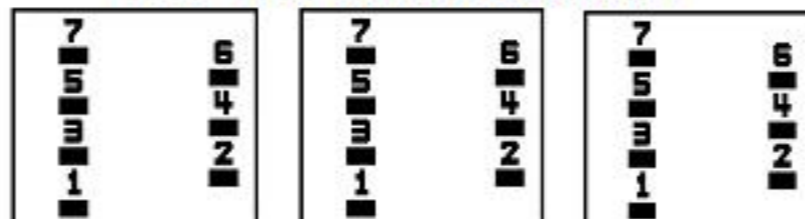

ELECTROSTATIC GROUND SHIELD IN EACH PHASE

ENCLOSURE TYPE 2 (IP30). RAINPROOF TYPE 3R ENCLOSURE (IP32) WHEN PROVIDED SHIELD 9T18W4317G05

Assembled in Mexico

BEFORE HANDLING, INSTALLING AND OPERATING, SEE INSTRUCTION 475A667AAP001
COPPER CONDUCTOR PRIMARY: 10 KV BIL SECONDARY: 10 KV BIL

Outline: 303B401MWP073

IN ACCORDANCE WITH NEC SECTION 450-9, ALLOW AT LEAST SIX INCHES
CLEARANCE FOR VENTILATION. CHECK ADDITIONAL NEC AND LOCAL CODES.

X3 - X2 - X1 - -
- H3 - H2 - H1

Note: X0 Terminal at the bottom

X3 - X2 - X1 -
- H3 - H2 - H1
X3 - X2 - X1 -
- H3 - H2 - H1
X0



2M000000

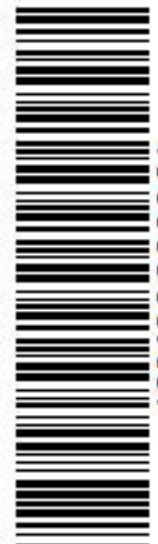

3M000000