



Transformer



1M000000

Catalog Number

TYPE QL

9T83W9874G90

75.0 KVA 60 HZ 3 PH 2.8 % IMP

40 C AMB. 80 C RISE 220 C SYSTEM IS-19C

Note: Design is based on 75.00KVA & 80C Rise 2.8% Imp.

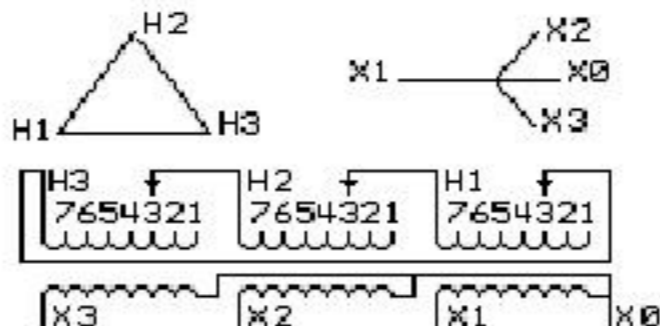

JUMPER CONNECTION	
TAP	VOLTS
1	505
2	490
3	480
4	470
5	455
6	445
7	430

NET WGT
 950 LB
 430.9 Kg
 9T40G00C7
 42975
 XV375
 NOG
 080315

INSPECTION
 &
 FINAL TEST
 N532!

PRIMARY (H) 480 VOLTS (LINE-LINE)
 SECONDARY (X) 208 VOLTS (LINE-LINE)
 120 VOLTS (LINE-NEUTRAL)

COIL TAP ARRANGEMENT

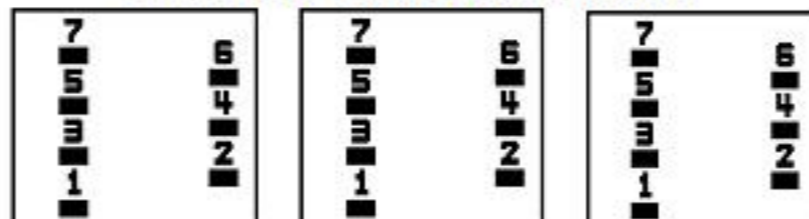

ENCLOSURE TYPE 2 (IP30). RAINPROOF TYPE 3R ENCLOSURE (IP32) WHEN PROVIDED SHIELD 9T18W4317G06

Assembled in Mexico

BEFORE HANDLING, INSTALLING AND OPERATING, SEE INSTRUCTION 475A667AAP001
 COPPER CONDUCTOR PRIMARY: 10 KV BIL SECONDARY: 10 KV BIL

Outline: 303B401MWP075

IN ACCORDANCE WITH NEC SECTION 450-9, ALLOW AT LEAST SIX INCHES
 CLEARANCE FOR VENTILATION. CHECK ADDITIONAL NEC AND LOCAL CODES.

X3 - X2 - X1 - -
 - H3 - H2 - H1

Note: X0 Terminal at the bottom



2M000000



3M000000

X3 - X2 - X1 - -
 - H3 - H2 - H1
 X3 - X2 - X1 - -
 - H3 - H2 - H1

X0