

CH12500H3C380TEZ-GM High-Efficiency Conduction-Cooled Rectifier

3 ϕ , 3-Wire 400/480V_{AC} Input; Default Output: 380V_{DC} (\pm 190V) @ 12,500W, 12V_{DC} @ 1.8A

RoHS Compliant



CH12500H3M380TEZ Shown with Optional Heatsink Kit

Applications

- Supercomputers
- 380Vdc data centers
- Telecom central offices
- Industrial systems

Targeted countries

Australia, Canada, European Union, India, Japan, New Zealand, South Korea, Taiwan, USA.

Description

The CH12500H3C380TEZ-GM is a high efficiency, true 3-phase, 3-wire (Delta) AC input, 380Vdc HVDC output, conduction cooled rectifier power supply. The true 3-phase input eliminates any neutral connection, and ensures tight phase current balancing. The rectifier achieves very high efficiency, >96%, reducing the cooling demands and providing beneficial OpEx savings. The rectifier meets world-wide safety, environmental, and regulatory requirements. The physical package is designed to allow very flexible positioning into system cabinets or racks. The rectifier can be mounted in both horizontal and vertical orientations, and its thin profile allows for minimal width when mounted vertically along cabinet's sides, or maximum stacking density when mounted horizontally in equipment racks. The width allows two rectifiers to be mounted side by side in standard 19 inch racks.

Features

- Efficiency 96.0% peak typical
- Compact form factor with 24W/in³ density
- Nominal Dimensions 60.3 x 203.2 x 711.2 mm (2.4 x 8.0 x 28.0 in)
- AC Input 3-wire, 3 Φ -400/480V_{AC}, 12,500W Rated Output
- Power factor correction (meets EN/IEC 61000-3-2 and EN 60555-2 requirements)
- High Resistance Mid-Point Ground (HRMG) \pm 190V_{DC} Output with Internal HRMG Fault detector circuit
- RS-485 Communication Protocol
- Output voltage programmable from 360-400V_{DC}
- Output overvoltage and overload protection
- AC Input overvoltage and undervoltage protection
- Over-temperature warning and protection
- Redundant, parallel operation with droop load sharing
- Redundant +12V_{DC} @ 1.8A Aux power
- Remote ON/OFF
- Integrated heatplate
- Hot insertion/removal (hot plug)
- Redundant DC output Interlock
- Three front panel LED indicators
- EN/IEC/UL/CSA C22.2 60950-1 2nd edition +A1
- CE mark[§]
- Meets FCC part 15 subpart B, EN55022 Class B standards
- Meets EN61000 immunity and transient standards
- Shock & vibration: Meets IPC 9592 Class II standards

* UL is a registered trademark of Underwriters Laboratories, Inc.

† CSA is a registered trademark of Canadian Standards Association.

‡ VDE is a trademark of Verband Deutscher Elektrotechniker e.V.

§ This product is intended for integration into end-user equipment. All CE marking procedures of end-user equipment should be followed. (The CE mark is placed on selected products.)

** ISO is a registered trademark of the International Organization of Standards

CH12500H3C380TEZ-GM High-Efficiency Conduction-Cooled Rectifier

3 ϕ , 3-Wire 400/480Vac Input; Default Output: 380V_{DC} (\pm 190V) @ 12,500W, 12Vdc @ 1.8A

Change History

V3.2 – December 19, 2018

p.4: Added Operating Case Temperature (Tref1, Tref2): 55, 58°C

p.12-13: Thermal Management section added

Absolute Maximum Ratings

Stresses in excess of the absolute maximum ratings can cause permanent damage to the device. These are absolute stress ratings only; functional operation of the device is not implied at these or any other conditions in excess of those given in the operations sections of the data sheet. Exposure to absolute maximum ratings for extended periods can adversely affect the device reliability.

Parameter	Symbol	Min	Max	Unit
Input Voltage: Continuous	V _{IN}	0	528	V _{AC}
Storage Temperature	T _{stg}	-40	85	°C
I/O Isolation voltage to Frame (100% factory Hi-Pot tested)			2121	V _{AC}

Electrical Specifications

Unless otherwise indicated, specifications apply over all operating input voltage, V_o=380V_{DC}, resistive load, and temperature conditions. To meet measurement accuracy a warm up time of 1hr may be required.

INPUT					
Parameter	Symbol	Min	Typ	Max	Unit
Operating Voltage Range (3 ϕ delta with safety frame ground)	V _{IN}	360	400/480	509	V _{AC}
Frequency	F _{IN}	47		63	Hz
Input current phase unbalance [load > 50% of FL]				2	%
Inrush Transient (per Φ at 480V _{RMS} , 25°C, excluding X-Capacitor charging)	I _{IN}		75	80	A _{pk}
Leakage Current (per Φ , 530V _{AC} , 60Hz)	I _{IN}			5 ¹	%
Power Factor (50 – 100% load)	PF	0.98	0.995		
Total Harmonic Distortion (50 – 100% load)	THD			5 ²	%
Efficiency (480V _{AC} @ 25°C)	η		90% 94% 96% 95%		%
Holdup time (V _{in} = 360V _{rms} , V _{out} \geq 320V _{DC} , 75% constant power load)	T	20	24		ms
Isolation (per EN60950)	V	3000 2000			V _{ac} V _{ac}

¹Leakage current shall not exceed 5% of the nominal input current per phase under testing. Appropriate marking requirements of UL 1950, CSA 950, and IEC/EN 60950 should be applied.

²Total harmonic distortion <6.5% when T_{ref} <5°C.

CH12500H3C380TEZ-GM High-Efficiency Conduction-Cooled Rectifier

3 Φ , 3-Wire 400/480Vac Input; Default Output: 380V_{DC} (\pm 190V) @ 12,500W, 12Vdc @ 1.8A

Electrical Specifications (continued)

380V _{DC} MAIN OUTPUT					
Parameter	Symbol	Min	Typ	Max	Unit
Output Power (360 – 432V _{AC} – 3 Φ , T _{INLET} = 2–50°C) (432 – 509V _{AC} – 3 Φ , T _{INLET} = 2–50°C)	W _{OUT}			10,417 12,500	W _{DC} W _{DC}
Output Voltage Factory Setpoint (480 Vac in, no load, 25°C)	V _{OUT}		385		V _{DC}
Output Voltage Programming Range (no load) Resolution		365	0.5	400	V _{DC} V _{DC}
Output Regulation (T _{INLET} = 2–45°C, LOAD > 2.5A) Load (programmed droop) Line, temperature & aging		-0.5	0.303	+0.5	V/A %
Output Current (V _{AC} =480, T _{INLET} = 45°C) V _{OUT} = 360V _{DC} (all 12,500W) V _{OUT} = 380V _{DC} V _{OUT} = 400V _{DC}	I _{OUT}	1		34.7 33 31.3	A _{DC}
Output Ripple (20MHz bandwidth, load > 1A) RMS (5Hz to 20MHz) Peak-to-Peak (5Hz to 20MHz)	V _{OUT}			90 800	mV _{rms} mV _{P-P}
Turn-On (monotonic from 30–100% of V _{nom}) Delay Rise Time Output Overshoot	T V _{OUT}		5 90		s ms %
Load Step Response Δ I [V _{IN} = 400–480V _{AC} , 25°C, load step 50% \leftrightarrow 100%, di/dt = 1A/ μ s] Δ V Settling Time to normal regulation	I _{OUT} V _{OUT} T	-4		50 4 1	%FL % ms
Overload Protection Current Limit (constant-current regulation) (V _{IN} = 432–509 Vac) (V _{IN} = 360–432 Vac) Fast Power Limit ³ (V _{IN} = 480 Vac) Slow Power Limit ³ (V _{IN} = 480 Vac) Undervoltage Shutdown ⁴ (after a 2–10 second delay) Severe Undervoltage Shutdown ³ (after a 0.5–10 second delay) Short-circuit protection Startup delay	I _{OUT} W _{OUT} V _{OUT}		37.4 31.5 13,500 12,500		A _{DC} W _{DC} V _{DC}
	No damage				
	Upon startup, overload shutdown is delayed for 20s to allow the insertion and startup of multiple modules within a system.				
Overvoltage Shutdown 200ms delayed shutdown (default) Immediate shutdown Programmable range Latched shutdown Restart delay	V _{OUT}	410 > 440 380	420	430 420	V _{DC}
	After 3 restart attempts within a 30 sec window, unit latches OFF				
		3.5	4	5	sec
Over-Temperature Power Reduction ³ Inception Recovery Typical Control Range Rate of Change	T _{INTERNAL} V _{OUT} W _{OUT}		90 (rising) 80 (falling) 320		°C V _{DC} W/sec
Over-Temperature Warning (OTW) LED indication - see Table 5)	T _{COMPONENT}		>90		°C
Over-Temperature Shutdown Restart	T _{COMPONENT}		100 (rising) 70 (falling)		°C
Restart/Reset conditions	Loss of input > 100ms or Output OFF followed by ON command				

³In Power Limit/Reduction mode, the output-voltage setpoint is lowered until the target output power is achieved.

⁴with one soft-start attempt after 10 seconds

12V _{DC} Auxiliary output ⁵					
Parameter	Symbol	Min	Typ	Max	Unit
Output Voltage Setpoint	V _{OUT}		12		V _{DC}
Overall Regulation		-10		+10	%
Output Current		0		1.8	A
Over-voltage Clamp			15	16.5	V _{DC}
Over-current Limit		105		135	%FL

⁵12V_{DC} auxiliary output will recover after over-current limit shutdown only if the load is less than 0.8A and output external capacitance is 500 μ F max. With high load and output capacitance, the input power must be recycled to get 12V_{DC} auxiliary output recovery.

CH12500H3C380TEZ-GM High-Efficiency Conduction-Cooled Rectifier

3 ϕ , 3-Wire 400/480Vac Input; Default Output: 380V_{DC} (\pm 190V) @ 12,500W, 12Vdc @ 1.8A

General Specifications

Parameter	Min	Typ	Max	Units	Notes
Unpacked Weight			13 (28)	Kgs (Lbs)	

Environmental Specifications

Parameter	Min	Typ	Max	Units	Notes
Operating Case Temperature (T _{ref1} , T _{ref2})			55, 58	°C	see Thermal Management Section
Operating Ambient Air Temperature	2		50	°C	
Operating Altitude			5000/16.4k	m / ft	
Non-operating Altitude			9000/30k	m / ft	
Shock and Vibration Operational	Meets IPC 9592 Class II, Section 5 and GR-63_CORE, Level 3 requirements				
Earthquake Rating	4			Zone	Design meets GR-63_CORE requirements ⁶

⁶When installed in a Zone 4 rated cabinet.

EMC [Surges and sags applied one ϕ at a time and all 3 ϕ 's simultaneously; phase angles 0°, 90°, 270°]

Parameter	Function	Standard	Level	Criteria	Test
AC input	Conducted emissions ⁷	EN55022, FCC part 15 EN61000-3-2 Telcordia GR1089-CORE	A		0.15 – 30MHz 0 – 2 KHz
	Radiated emissions ⁷	EN55022/CISPR22, FCC part 15 Subpart B, ICES-003, KN22, CNS 13438	B – 3dB margin		30 – 10000MHz
	Input Harmonics	EN61000-3-2	A		
AC Input Immunity	Line sags and interruptions	EN61000-4-11	Class 3	A	-30% (from 400Vac) for 10ms
		Output will stay above 320V _{DC} @ 75% load		A	25% sag from nominal (400Vac) for 0.5 sec 1 cycle interruption
	Lightning surge	EN61000-4-5, Level 4, 1.2/50 μ s – error free		A	4kV L-E 2kV L-L
		ANSI C62.41-2002 100kHz ring wave 1.2/50 μ s-8/20 μ s 5/50ns EFT burst	3, Category B 3, Category B	B, Table 2 B, Table 3 B, Table 6	6kV/0.5kA 6kV, 3kA 2kV, severity II
	Fast transients	EN61000-4-4	3	A	5/50ns, 2kV (common mode)
Enclosure immunity	Conducted RF fields	EN61000-4-6	3	A	130dB μ V, 0.15-80MHz, 80% AM
	Radiated RF fields	EN61000-4-3	3	A	10V/m, 80-1000MHz, 80% AM
	Power Frequency Magnetic Fields	EN61000-4-8		A	30A/m
	ESD	EN61000-4-2	4	A	8kV contact, 15kV air

⁷Tested with GE shelf, external AC input filter, and shielded DC output cables

Criteria Performance

- A No performance degradation
- B Temporary loss of function or degradation not requiring manual intervention
- C Temporary loss of function or degradation that may require manual intervention
- D Loss of function with possible permanent damage

CH12500H3C380TEZ-GM High-Efficiency Conduction-Cooled Rectifier

3 ϕ , 3-Wire 400/480Vac Input; Default Output: 380V_{DC} (\pm 190V) @ 12,500W, 12Vdc @ 1.8A

Feature Descriptions

Hot swap: The rectifier is equipped with an interlock switch which operates in a redundant scheme with the Interlock short connector pin to ensure output voltage is not present on the output connector while removing or inserting the rectifier into the shelf.

Power limiting: There are three distinct mechanisms which trigger power limiting, in which the output voltage is lowered below the programmed value only as much as necessary to achieve the target output power. The purpose of power limiting is to protect the rectifier while giving the larger system time to reduce the load and avoid the disruption of a rectifier shutdown.

The first two mechanisms described below are for overload--above the rectifier rating--while the third occurs below the rectifier rating to prevent overheating. In each case if the load is reduced, the output voltage is raised until it returns to its normal programmed value, ending power limiting. The Over-Power Warning signal described in the next section is asserted for the first two limits below.

1. **Fast Power Limit** reduces output power as quickly as possible to the threshold value, essentially clamping output power.
2. **Slow Power Limit** is triggered by a training-average power calculation, to allow short overloads that are below the fast power limit while preventing extended operation above the rectifier rating. Depending on the severity of the overload & prior load, this limit acts after approximately 2-3 seconds, reducing output power to the rated value over a few more seconds. When in Slow Power limit, the rectifier has a one minute on-time followed by a two minute off-time. This cycle repeats until output current is reduced below the slow power limit threshold.
3. **Over-Temperature Power Reduction** to below the rectifier power rating occurs when the rectifier internal temperature approaches its operating limit. Output voltage is lowered gradually until the internal temperature falls below the inception threshold. The output voltage is regulated at this level until the internal temperature then falls below the "recovery" threshold. In recovery, the output voltage is gradually raised back to the programmed value, unless the "inception" threshold is exceeded again. If the OT power reduction fails to arrest the temperature rise, e.g. for a total loss of cooling, an over-temperature shutdown is triggered.

Control and Status

The Rectifier provides two means for monitor/control, analog and the GE RS-485 protocol.

Analog Control Signals

Rectifier Enable: Controls the main 380V_{DC} output. This pin must be pulled low to LGND to turn **ON** the power supply. The power supply will turn **OFF** if either **Rectifier Enable** or **Interlock** are released.

Interlock: The rectifier operates a redundant interlock scheme using a handle-actuated switch and an interlock pin. When opened, the handle-actuated switch shuts down the 400V bus, 12V aux, keeping the internal bias / communication on. The interlock pin is a short signal pin that shuts down the rectifier completely upon extraction. The interlock pin must be connected to SEC_RTN on the system side. The interlock features work in conjunction to ensure that no arcing or connector contact damage occurs to the connector during the hot insertion/extraction process.

Slot Identification: Up to 10 different units are selectable by connecting a resistor between SLOT_ID and SEC_RTN. Internally this pin is pulled up to 3.3V (\pm 3%) by a 10 kOhm (\pm 1%) resistor. The full tolerance range of the chosen resistor should fall between the minimum and maximum values of R_s listed below to ensure the correct slot number is identified.

Slot_ID	Min V _s	Max V _s	Min R _s (k Ω)	Max R _s (k Ω)	Std 1% (k Ω)
Invalid	3.20	3.40	open (no resistor)		none
1	2.89	3.10	92.2	103	100
2	2.56	2.79	39.9	44.9	43
3	2.23	2.46	23.0	25.7	24
4	1.90	2.13	14.7	16.5	15
5	1.57	1.80	9.66	11.1	10
6	1.24	1.47	6.34	7.50	6.8
7	0.905	1.135	3.98	4.96	4.7
8	0.575	0.805	2.21	3.07	2.7
9	0.230	0.475	0.782	1.61	1
10	0.000	0.130	0.000	0.394	0

Analog Status Signals

Module Present: This signal is used as an OUTPUT signal by the power supply to notify the system controller that a power supply is physically present in the slot. This signal pin is pulled down to LGND by the power supply.

Over-Power Warning (OPW): This signal is HI during normal operation but asserted LO during operation at output power greater than the rectifier rating. This enables load power to be reduced before the Slow Power Limit acts.

If the overload is less than the rectifier Fast Power Limit, OPW is asserted after some delay to allow for short overloads without disruption. OPW is triggered by a training-average power calculation, which shortens the delay for higher loads during and/or before the overload. For example, a repeating 2 seconds of 13.1 kW load followed by 0.8 second of 6.65 kW will NOT trigger OPW, but lengthening the overload pulse to 2.3 seconds WILL trigger OPW intermittently after a few cycles.

If the overload is greater than the Fast Power Limit, OPW is asserted immediately and power is reduced to the fast threshold without warning.

CH12500H3C380TEZ-GM High-Efficiency Conduction-Cooled Rectifier

3 ϕ , 3-Wire 400/480Vac Input; Default Output: 380V_{DC} (\pm 190V) @ 12,500W, 12Vdc @ 1.8A

GE RS-485 protocol

GE will provide separate application notes on the RS-485 based protocol physical, data, and link layers for users to interface to the rectifier. Contact your local GE representative for details.

Application Layer: The controller interacts with the system devices using the READ, WRITE, and READ RESPONSE packets. Each packet carries a unique body that details the variables and values of interest in the system device. A READ packet transmits the variable name to the system device, which then returns a value to the controller with the READ RESPONSE packet. The WRITE packet transmits a variable name and new value to a system device, which records it. The WRITE packet is also used to cause specific actions to occur within the device. The variable names and commands that are found in the packet bodies define the Galaxy Power System application. The tables following this section will detail the specific packet body contents. First described are the basic data types used widely in the application. Generic variables that all devices must support are then described followed by the unique variables associated with specific devices.

Table 1 - Basic Data Types

Data Types	Data Type Definition
null	no value
uint8_t	8-bit unsigned integer
uint16_t	16-bit unsigned integer
int16_t	16-bit signed integer
uint32_t	32-bit unsigned integer
int32_t	32-bit signed integer

Note: All multi-byte integer data types are BIG ENDIAN format (MSB, LSB)
Signed numbers are in two's complement format.

Table 2 - Device Group Number Definitions

Variable Name	Group	Description
MASTER_ADDR	00h	Plant controller
BROADCAST	FFh	Broadcast address to all devices
RECTIFIER_ADDR	E8h	High voltage rectifier

Table 3 - Variable Allocation

Variable Range	Description
00h to 0Ah	Common variables (0Ah read is not common, just write)
0Bh to 9Fh	Group specific variables, common within a given group
0Ah to AFh	Upgrade related commands
0Bh to DFh	Group specific variables
0Eh to FFh	Device specific commands typically for lab and debugging. May not be common within a group

Scaling: Analog quantities are scaled (multiplied) by the following factors, then truncated to an integer:

- DC voltage and current 64
- AC voltage 100
- AC current 200
- Temperature in °C 1
- Watts 1

CH12500H3C380TEZ-GM High-Efficiency Conduction-Cooled Rectifier

3 ϕ , 3-Wire 400/480Vac Input; Default Output: 380V_{DC} (\pm 190V) @ 12,500W, 12Vdc @ 1.8A

Table 4 – RS-485 Variable List

Variable Name	Num	Len	Data Type	Description
DUMMY_RW	00h	00h	null	Used to exercise the protocol for test purposes.
SERIAL_NUMBER_RW	01h	12h	uint8_t[18]	Serial number as an array of 18 ASCII characters. (e.g. LBGEP16KZ00000000)
GROUP_ADDRESS_RW	02h	01h	uint8_t	Rectifier group address E8h (multi-cast address)
COMCODE_RW	03h	0Bh	uint8_t[11]	GE internal part number up to 11 ASCII characters: (e.g. 150047061)
PROTOCOL_CONTROL_W	04h	01h	uint8_t	01h – forces devices to drop the link
STATION_TYPE_R	05h	14h	uint8_t[20]	GE product code, up to 20 ASCII characters (e.g. CH12500H3C380TEZ-GM)
SERIES_RW	06h	07h	uint8_t[7]	GE series identifier, up to 7 ASCII characters (e.g. 1:0)
APPLICATION_VERSION_R	07h			Software version: 70h returns PFC version, 73h returns DCDC version Format: major,minor,month,day, year, hours, minutes Note: If no argument then DCDC version is returned
Argument:		01h	uint8_t	
Response:		07h	uint8_t[7]	
reserved	08h			Reserved
TIMEOUT_SCALE_RW	09h	01h	uint8_t	No-activity link timeout in seconds. Default: 10
LAMP_TEST_W	0Ah	00h	null	Lamp Test command
I_R	0Ah	02h	uint16_t	Total output current of rectifier
T_INTERNAL_R	0Bh	01h	uint8_t	Most critical temperature
STATUS_R	0Ch	02h	uint16_t	<u>Device status</u> 0001h: 1 = ORing FET failure detected 0002h: 1 = AC out of range 0004h: 1 = Vout unbalance warning 0008h: 1 = Over temperature shutdown ----- 0010h: 1 = Rectifier failure detected 0020h: 1 = low input-voltage range (< 432 Vac; power limited) 0040h: Reserved 0080h: Reserved ----- 0100h: 1 = interlock is open 0200h: 1 = Standby from controller requested 0400h: 1 = Over voltage shutdown (requires restart) 0800h: 1 = On and producing power ----- 1000h: Reserved 2000h: Reserved 4000h: Reserved 8000h: 1 = in current limit or power limit
ORFET_FAIL_STAT				
ACF_STAT				
VOUT_UNBALANCE				
TA_STAT				
RFA_STAT				
AC_LOW_LINE_STAT				

INTERLOCK_STAT				
TRH_STAT				
HVSD_STAT				
ON_STAT				

ID_CHANGED_STAT				

CL_STAT				
VSET_RW	0Eh	02h	uint16_t	Power up default voltage set-point
CMD_W	0Fh	02h	uint16_t	<u>Device control</u> 0001h: Place rectifier into Standby 0002h: Release rectifier from Standby 0004h: Reserved 0008h: Reserved ----- 0010h: Reserved 0020h: Restart after over voltage or over current 0040h: Lamp test 0080h: Reserved ----- 0100h: Request fault LED ON 0200h: Request fault LED OFF 0400h: Not used 0800h: Not Used ----- 1000h: Not Used 2000h: Not Used 4000h: Not Used 8000h: Reset energy counter
STANDBY_CMD				
ON_CMD				

RESTART_CMD				
LAMPTEST_CMD				

FAULT_LED_ON				
FAULT_LED_OFF				

RESET_ENERGY_CMD				
CAPACITY_R	11h	02h	uint16_t	Nominal current capacity of rectifier (Idc x 64)
VCMD_RW	13h	02h	uint16_t	Present output voltage setting
VOP_R	20h	02h	uint16_t	Output voltage measurement
VACIN_RMS_R	29h	06h	uint16_t uint16_t uint16_t	Line-to-line AC RMS voltage measurements Vab Vbc Vca

CH12500H3C380TEZ-GM High-Efficiency Conduction-Cooled Rectifier

3φ, 3-Wire 400/480Vac Input; Default Output: 380V_{DC} (±190V) @ 12,500W, 12V_{dc} @ 1.8A

IACIN_RMS_R	2Ah	06h	uint16_t uint16_t uint16_t	AC RMS phase current measurements Phase A Phase B Phase C
AC_POWER_R	37h	02h	uint16_t	AC input power in Watts
ON_TIME_R	39h	04h	uint32_t	Hours on and producing power
BLOCK_READ_R	73h	0Bh	Uint16_t uint16_t Uuint32_t Uuint16_t Int8_t	Block read Status word Vout measurement Accumulated energy in J Average Output Power in Watts Temperature in C

Table 5: Alarm and LED state summary

Condition	Power Supply LED State		
	AC OK Green	Fault Red	DC OK Green
OK	1	0	1
Over-Temperature Warning (OTW) 5°C before shutdown)	1	Blinks	1
Thermal Shutdown	1	1	0
Blown AC Fuse in Unit	Blinks	1	0
AC Present but not within limits	Blinks	0	0
AC Lost (indicated for 0.5-1 min)	Yellow	0	0
Boost Stage Failure	1	1	0
Over Voltage Latched Shutdown	1	1	0
Over Current	1	0	Blinks
Non-catastrophic Internal Failure	1	1	1
Standby (remote)	1	0	0
Output Unbalance	1	0	Blinks Yel / Grn

Table 6: Signal Definitions

Pin	Function	Label	Type	Description
2A	Interlock	INTERLOCK	Input	Short pin that must be connected to SEC_RTN externally to enable the output. This signal provides the last-to-make and first-to-break function to prevent arcing during hot plug and hot disengagement.
2B	Slot identification	SLOT_ID	Input	Set to one of 10 levels by an external resistor to SEC_RTN.
2C	Secondary return	SEC_RTN	Reference	Filtered connection to Vout-.
(Signals above are referenced to SEC_RTN; signals below are referenced to LGND)				
5B	Over-Power Warning	OPW	Output	Open-drain FET; normally open
5D, 6D	Standby power	12V_AUX	Output	12V @ 1.8A provided for external use; return is LGND. This output is always ON and OR'ed for paralleling.
6B	RS485 A signal	RS485_A	I/O	RS485 "+" or non-inverting signal line.
6C	RS485 B signal	RS485_B	I/O	RS485 "-" or inverting signal line.
7A	Rectifier Enable	ENABLE	Input	When shorted to LGND, turns ON the main output
7B	Module Present	MOD_PRES	Output	Short pin connected to LGND, notifies the system that this module is present,
7C, 7D	Logic Ground	LGND	Reference	Isolated from the main output & SEC_RTN.

CH12500H3C380TEZ-GM High-Efficiency Conduction-Cooled Rectifier

3φ, 3-Wire 400/480Vac Input; Default Output: 380V_{DC} (±190V) @ 12,500W, 12V_{DC} @ 1.8A

Connector

Installed in rectifier: TE 4-6450832-7 (pictured below)

- Example mate: 1 ea. TE 1-1892903-9 housing + 8 ea. TE 1600903-1 power receptacles + 7 ea. TE 1600902-1 four-position signal inserts

PART NUMBER	ROWS	POWER														SIGNAL							
		P1	P2	P3	P4	P5	P6	P7	P8	P9	P10	P11	P12	P13	P14	P15	1	2	3	4	5	6	7
4-6450832-7	D															-	-	J	J	J	J	J	J
	C	TM	TM	TM	TM	-	-	-	TM	TM	-	-	-	TM	TM	-	-	-	K	K	K	K	K
	B															-	-	G	G	G	G	G	G
	A															-	-	H	H	H	H	H	H

15P + 28S

- NO CONTACTS LOADED

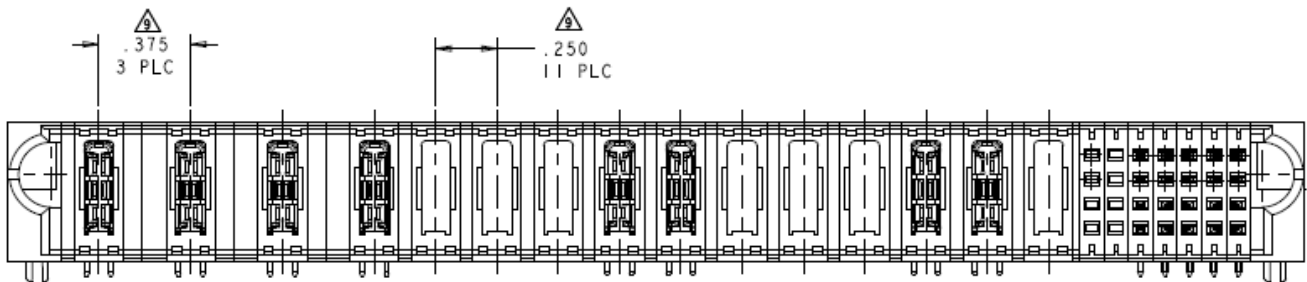

Facing rear of module

AC INPUT				DC OUTPUT											SIGNALS							
P1	P2	P3	P4	P5	P6	P7	P8	P9	P10	P11	P12	P13	P14	P15	1	2	3	4	5	6	7	
L1	L2	L3	Frame Gnd	Empty	Empty	Empty	Vout +	Vout +	Empty	Empty	Empty	Vout -	Vout -	Empty	Empty	RESERVED	Empty	Empty	12V_AUX	12V_AUX	LGND	D
															Empty	SEC_RTN	Empty	Empty	RESERVED (RACK_ID)	RS485_B	LGND	C
															Empty	SLOT_ID	Empty	Empty	OPW	RS485_A	MOD_PRES	B
															Empty	INTERLOCK	Empty	Empty	RESERVED (DCOK)		ENABLE	A

PWB

- = Short Pin
- = System side mating connector must have its Frame GRD pin the longest to ensure that it is mating first.

Connected Internally:

- P8 & P9
- P13 & P14
- D5 & D6
- C7 & D7

CH12500H3C380TEZ-GM High-Efficiency Conduction-Cooled Rectifier

3 ϕ , 3-Wire 400/480Vac Input; Default Output: 380V_{DC} (\pm 190V) @ 12,500W, 12Vdc @ 1.8A

Cable Assembly

For convenient connection without a shelf (see photo under "Accessories").

Connectors:

AC Installed: Molex 42818-0412 4-circuit single-row 10mm-pitch Mini-Fit Sr.TM housing + crimp terminals Molex 42817-0032 (ground) & 3 ea. Molex 42817-0012:

- Example mate: Molex 42816-0412 Receptacle Housing + 4 ea. Molex 42815-0012 - female crimp terminals, 12-10 AWG

DC Installed: 4 ea. TE 640907-2 female Fast-on

Signal installed: Molex 43025-1400 Micro-Fit 3.0TM housing + 12 ea. Molex 43030-0002 female crimp terminals

- Example mate: Molex 43045-1413 Vertical Header, Dual Row, 14 circuits

Pin	Function	Name	Rectifier
1	RS485 signal B (inverting)	RS485_B	6C
2	Logic Ground (signal return)	LGND	7D
3	12V+	12V_AUX	6D
4	Module present	MOD_PRES	7B
5	Enable	ENABLE	7A
6	rsvd blank		
7	Secondary Return	SEC_RTN	2C
8	RS485 signal A (non-inverting)	RS485_A	6B
9	Logic Ground (signal return)	LGND	7C
10	12V+	12V_AUX	5D
11	Over Power Warning	OPW	5B
12	rsvd blank		
13	Slot ID	SLOT_ID	2B
14	Interlock	INTERLOCK	2A

INTERLOCK (pin 14) must be connected to SEC_RTN (pin 7) to enable the rectifier.

Rectifier signals not available from harness:

- DC_OK (5A)
- RACK_ID (5C)

CH12500H3C380TEZ-GM High-Efficiency Conduction-Cooled Rectifier
 3φ, 3-Wire 400/480Vac Input; Default Output: 380V_{DC} (±190V) @ 12,500W, 12V_{dc} @ 1.8A

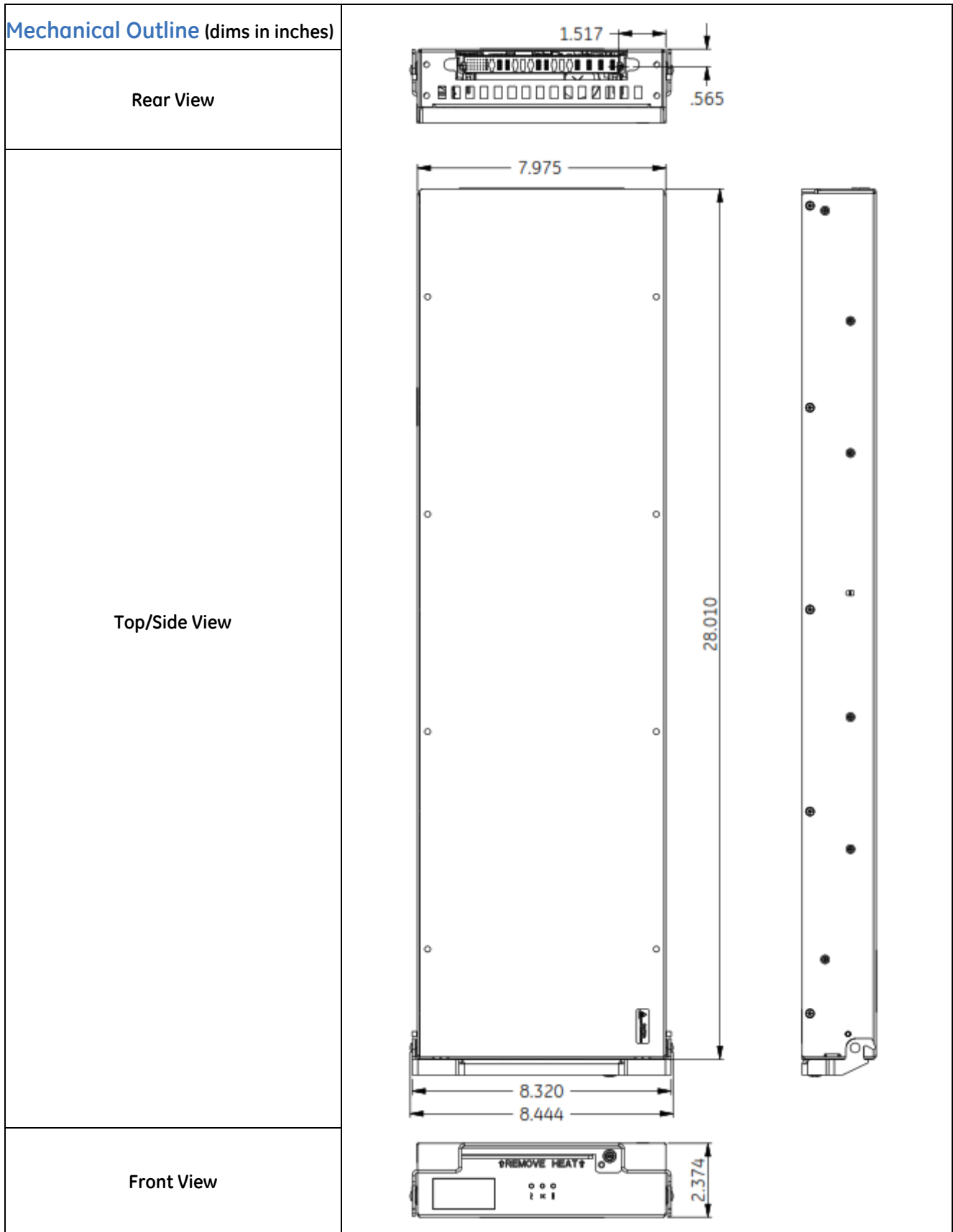

CH12500H3C380TEZ-GM High-Efficiency Conduction-Cooled Rectifier

3φ, 3-Wire 400/480Vac Input; Default Output: 380V_{DC} (±190V) @ 12,500W, 12V_{dc} @ 1.8A

Thermal Management

The CH12500H3C380TEZ-GM rectifier is built with an integrated heat spreader plate that should be coupled to an external cold plate, heatsink or other cooling mechanism. Eight (8) mounting holes are provided to aid in mounting the cooling device to the rectifier, as shown below (all dimensions in inches):

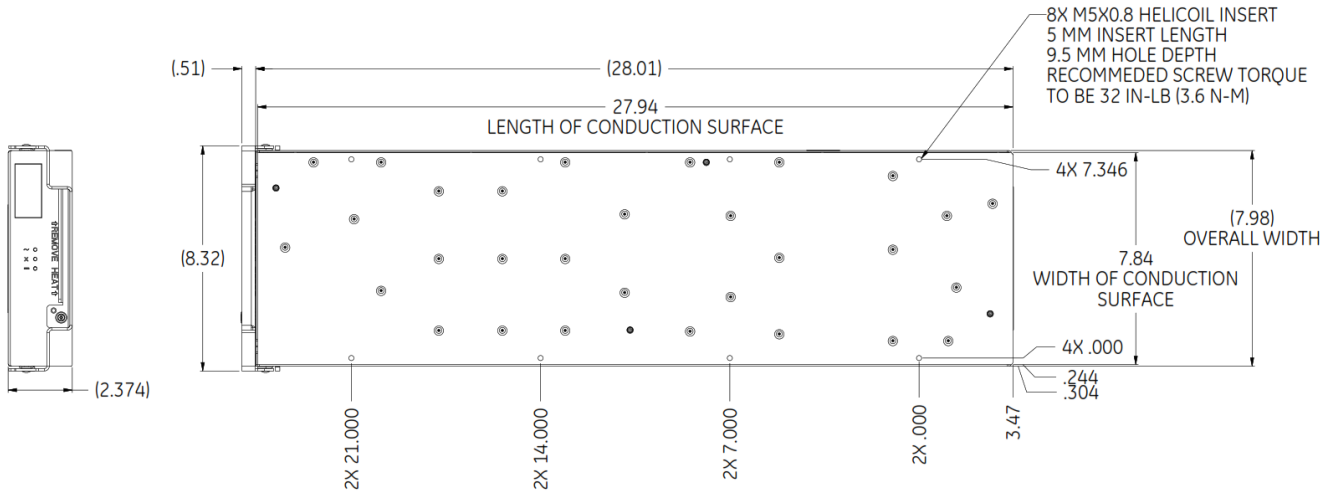

THERMAL INTERFACE INFORMATION

The rectifier cooling surface is indicated by the “↑REMOVE HEAT↑” text located on the front panel. The cooling device mating surface should be sufficiently flat to insure good thermal coupling. Full coverage of thermal grease (Tgrease 300X, 4600140917P) should be used in the interface between the rectifier heat spreader plate and the cooling device.

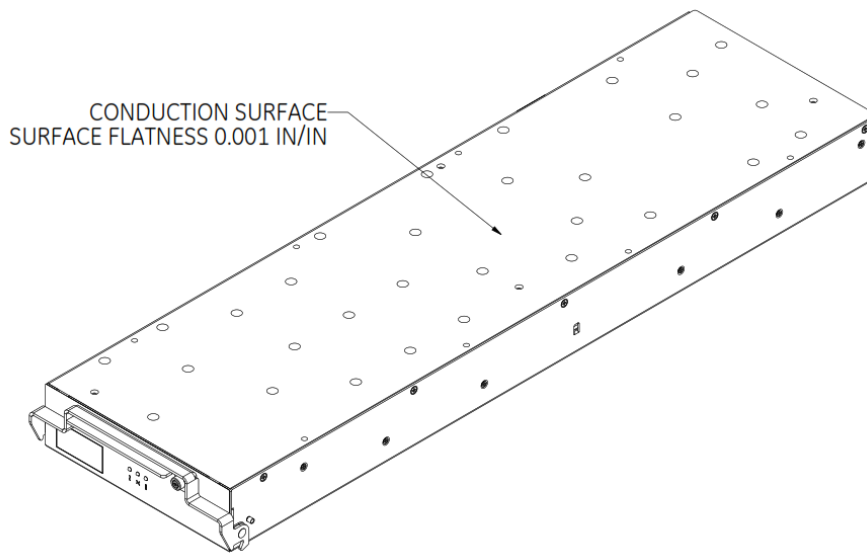

CH12500H3C380TEZ-GM High-Efficiency Conduction-Cooled Rectifier

3 ϕ , 3-Wire 400/480Vac Input; Default Output: 380V_{DC} (\pm 190V) @ 12,500W, 12Vdc @ 1.8A

Two reference temperature locations (hot spots) have been identified and should be monitored during cooling system validation. To insure maximum power output of the rectifier, adequate cooling must be provided to keep the reference temperatures below the following maximum limits. Lowering operating ambient temperature may also be used when cooling device capacity is limited. Failure to maintain reference temperature location below the prescribed limits will result limited power or shutdown due to thermal protection.

Reference temperature location maximums:

T_{ref1} = 55°C max

T_{ref2} = 58°C max

The reference temperature locations are shown below (all dimensions in inches):

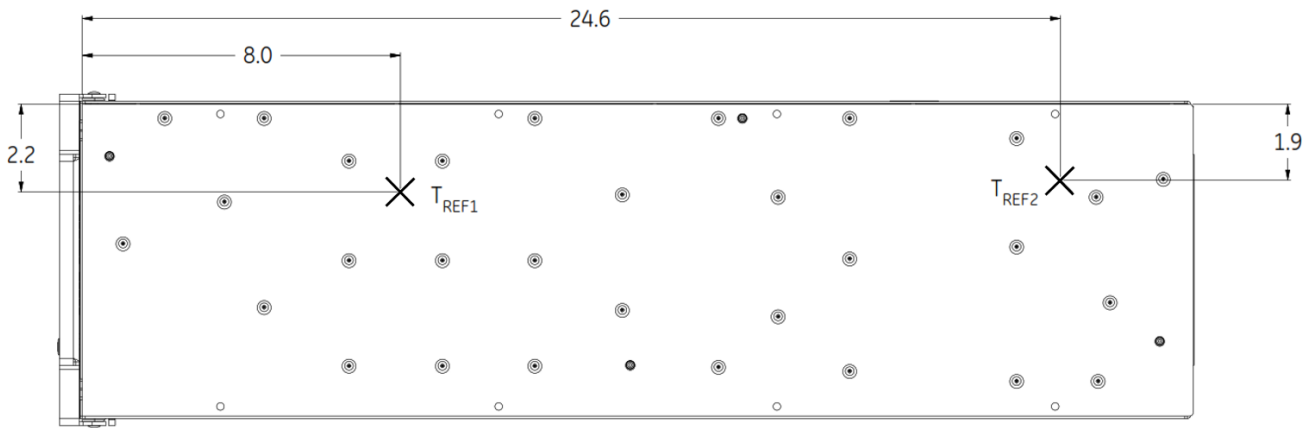

REFERENCE TEMPERATURE LOCATIONS

CH12500H3C380TEZ-GM High-Efficiency Conduction-Cooled Rectifier

3φ, 3-Wire 400/480Vac Input; Default Output: 380V_{DC} (±190V) @ 12,500W, 12Vdc @ 1.8A

Accessories

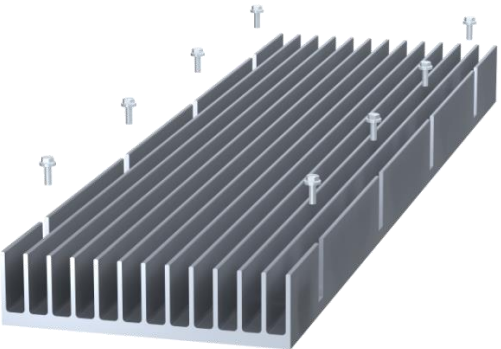
Item	Description	Comcode
	Single-unit cable assembly that mates with rectifier Blind-Mate connector. (sold as a component; equipment containing this harness requires safety certification)	8600164177P
	CH12500 Heatsink assembly (heatsink, mounting hardware and thermal grease)	1600125038A
Thermal Grease	Tgrease 300X 30cc syringe	4600140917P

Ordering Information

Please contact your GE Sales Representative for pricing, availability and optional features.

Item	Description	Comcode
CH12500H3C380TEZ-GM	12.5kW 400/480Vac-to-380VDC Conduction-Cooled Rectifier	1600096898A

Contact Us

For more information, call us at

USA/Canada:

+1 877 546 3243, or +1 972 244 9288

Asia-Pacific:

+86.021.54279977*808

Europe, Middle-East and Africa:

+49.89.878067-280

www.gecriticalpower.com



GE Critical Power reserves the right to make changes to the product(s) or information contained herein without notice, and no liability is assumed as a result of their use or application. No rights under any patent accompany the sale of any such product(s) or information.