

## CLP0112 Open Frame Power Supply

90 - 265Vac input; 12Vdc output; 150W Output Power

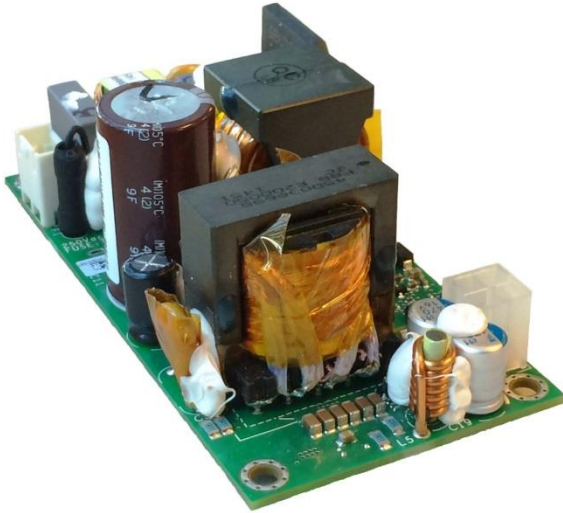

### Applications

- Telecommunications equipment
- Embedded Computing
- Storage Systems
- Industrial equipment

### Description

In a small 2 x 4 inch footprint, the 12Vdc single-output CLP0112 open frame power supply delivers greater than 90 percent typical power efficiency and full load output at 75°C. With its small size, the CLP series is specifically designed to handle power challenges associated with tight space and low airflow. The CLP series utilizes a unique design approach at this power level, leveraging zero voltage switching techniques in conjunction with quasi-resonant power factor correction (PFC) circuits. Protection features include overcurrent (OCP), overvoltage (OVP), and overtemperature (OTP).

### Features

- Compact size 50.8 mm x 101.6 mm x 36.1 mm (2 in x 4 in x 1.4 in) with density of 13.4W/in<sup>3</sup>
- Universal AC Input Range (90 – 265VAC)
- Output voltage of 12V (adjustable -2.5/+5%)
- Maximum output current of 12.5A@ 12Vout (150W)
- High efficiency
- Full load capability at 75°C and 1m/s (200LFM) airflow with derating at higher temperatures or lower airflows
- When used inside sealed enclosure, can deliver 130W @ 55C outside ambient temperature
- Output overcurrent protection (non-latching)
- Overtemperature protection
- Output overvoltage protection
- Up to 11ms of holdup time
- Active power factor corrected input
- Conducted EMI - meets CISPR22 (EN55032) and FCC Class B requirements
- Meets IEC61000-4-5, Level 4 (2kv/4kv)
- Compliant to RoHS Directive 2011/65/EU and amended Directive (EU) 2015/863
- Compliant to REACH Directive (EC) No 1907/2006
- 1mil Conformal coated Z02A version passed Salt/Fog test and Mixed Flow Gas test
- Fuse in Neutral line in Z03A version for Japan market
- UL and cUL approved to UL/CSA62368-1, TUV (EN62368-1), CE Mark (for LVD) and CB Report available
- ISO\*\* 9001 and ISO 14001 certified manufacturing facilities

\* UL is a registered trademark of Underwriters Laboratories, Inc.

† CSA is a registered trademark of Canadian Standards Association.

‡ VDE is a trademark of Verband Deutscher Elektrotechniker e.V.

\*\* ISO is a registered trademark of the International Organization of Standards

# CLP0112 Open Frame Power Supply

## 90 - 265Vac input; 12Vdc output; 150W Output Power

### Absolute Maximum Ratings

Stresses in excess of the absolute maximum ratings can cause permanent damage to the device. These are absolute stress ratings only, functional operation of the device is not implied at these or any other conditions in excess of those given in the operations sections of the data sheet. Exposure to absolute maximum ratings for extended periods can adversely affect the device reliability.

| Parameter  | Device | Min | Max  | Unit |
|--|--------|-----|------|------|
| Input Voltage - Continuous   | All    | 90  | 265  | Vac  |
| For up to 10 seconds max.  | All    | 90  | 275  | Vac  |
| Operating Ambient Temperature<br>(see Thermal Considerations section)                                    | All    | -40 | 85   | °C   |
| (in sealed enclosure applications with thermally conductive pad to enclosure, P <sub>o,max</sub> = 130W) | All    | -40 | 55   | °C   |
| Storage Temperature  | All    | -40 | 85   | °C   |
| Humidity (non-condensing)  | All    | 5   | 95   | %    |
| Altitude   | All    |     | 5000 | m    |
| Isolation Voltage – Input to output  | All    |     | 3000 | Vac  |
| Input to safety ground   | All    |     | 1500 | Vac  |
| Outputs to safety ground   | All    |     | 50   | Vac  |

† Ambient temperature outside the sealed enclosure containing the power supply.

### Electrical Specifications

| Parameter  | Device | Min  | Typ     | Max  | Unit                 |
|--|--------|------|---------|------|----------------------|
| Operating Input Voltage  | All    | 90   | 115/230 | 265  | Vac                  |
| Input Source Frequency   | All    | 47   | 50/60   | 63   | Hz                   |
| Input Current (V <sub>IN</sub> = 90Vac)  | All    |      |         | 3    | A <sub>RMS</sub>     |
| Input Power Factor (115VAC or 230VAC in at full load)  | All    | 0.95 |         |      |                      |
| Inrush Transient Current (V <sub>IN</sub> = 265Vac, T <sub>amb</sub> = 25°C)   | All    |      |         | 100  | A Peak               |
| Leakage Current to earth ground (V <sub>IN</sub> = 265Vac)   | All    |      |         | 2    | mA                   |
| Output Voltage Setpoint  | All    |      | 12      |      | Vdc                  |
| Output Voltage Tolerance (due to set point, temperature variations, load and line regulation)  | All    | -3   |         | 3    | %                    |
| Output Voltage Adjustment Range  | All    | 11.7 |         | 12.6 | Vdc                  |
| Output Load Regulation   | All    |      |         | 1    | %Vout                |
| Output Line Regulation   | All    |      |         | 0.5  | %Vout                |
| Output Ripple and Noise – measured with 0.1µF ceramic capacitor in parallel with 10µF tantalum capacitor, at 25°C <sup>1</sup><br>Peak-to-peak (20MHz Bandwidth) | All    |      |         | 180  | mV p-p               |
| Dynamic Load Response – 50% to 75% load transient, 0.1A/µs slew rate.  | All    |      |         |      |                      |
| Output voltage deviation   | All    |      |         | 5%   | %                    |
| Settling Time  | All    |      |         | 500  | µs                   |
| Output Current   | All    | 0    |         | 12.5 | A <sub>dc</sub>      |
| Output Current Limit Inception   | All    | 110  |         | 145  | % I <sub>o,max</sub> |
| Maximum Output Capacitance   | All    |      |         | 5000 | µF                   |
| Efficiency at 25°C:  |        |      |         |      |                      |
| V <sub>IN</sub> = 230Vac, 20% load   | All    |      | 89.3    |      | %                    |
| 50% load   | All    |      | 92.9    |      | %                    |
| 100% load  | All    |      | 92.7    |      | %                    |
| V <sub>IN</sub> = 115Vac, 20% load   | All    |      | 87.7    |      | %                    |
| 50% load   | All    |      | 90.9    |      | %                    |
| 100% load  | All    |      | 90.5    |      | %                    |
| Holdup Time <sup>2</sup> – V <sub>IN</sub> = 115Vac or 230Vac, 100% load   | All    | 11   |         |      | ms                   |

<sup>1</sup> Below -25°C, ripple may exceed the specified level. Specification will be met after warm up period of 15s.

<sup>2</sup> Holdup time may be lower at cold temperatures

## CLP0112 Open Frame Power Supply

90 - 265Vac input; 12Vdc output; 150W Output Power

## General Specifications

| Parameter  | Device | Symbol | Typ.      | Unit                   |
|--|--------|--------|-----------|------------------------|
| Calculated Reliability based on Telcordia SR-332 Issue 2: Method 1 Case 3 (V <sub>IN</sub> =230Vac, I <sub>o</sub> = 12.5A, T <sub>A</sub> = 40°C, airflow 200LFM, 90% confidence) | All    | FIT    | 201.6     | 10 <sup>9</sup> /Hours |
|  |        | MTBF   | 4,960,060 | Hours                  |
| Weight   | All    |        | 184       | g                      |
|  |        |        | 6.5       | oz.                    |

## Feature Specifications

| Parameter  | Device | Min  | Typ | Max  | Unit |
|--|--------|------|-----|------|------|
| Output Voltage Rise Time (from 10 to 90% of final value)                       | All    |      | 4.2 |      | ms   |
| Delay from Input being applied to all outputs being in regulation <sup>3</sup> | All    |      |     | 1000 | ms   |
| Output Overvoltage Protection (for main output currents above 0.1A)            | All    | 13.8 |     | 17   | Vdc  |
| Input Undervoltage lockout <sup>4</sup>  |        |      |     |      |      |
| Turn-on Threshold (100% load)  | All    |      | 83  | 90   | Vac  |
| Turn-off Threshold (100% load)   | All    |      | 72  | 88   | Vac  |

## Environmental Specifications

| Parameter                             | Device | Specification                                     |
|---------------------------------------|--------|---|
| Conducted Emissions                   | All    | CISPR32 (EN55032) Class B with 3dB margin         |
| Radiated Emissions <sup>5</sup>       | All    | CISPR32 (EN55032) to comply with system enclosure |
| Input Harmonics                       | All    | EN61000-3-2                                       |
| ESD                                   | All    | IEC 61000-4-2, Level 3                            |
| Radiated Immunity <sup>6</sup>        | All    | IEC 61000-4-3, Level 2                            |
| Electrical Fast Transient Common Mode | All    | IEC 61000-4-4, Level 3                            |
| Surge Immunity                        | All    | IEC 61000-4-5, Level 4                            |
| Conducted RF Immunity                 | All    | IEC 61000-4-6, Level 3                            |
| Voltage Dips                          | All    | EN61000 4.11, Level 3, Class B, C                 |
| Shock and Vibration                   | All    | IPC-9592B   |

<sup>3</sup> Met when temperature is above -25°C and restart duration is ≤ 20s.

<sup>4</sup> Undervoltage lockout threshold may vary with output load current level – decreasing as load goes lower

<sup>5</sup> Shall be met when tested in a suitable enclosure

<sup>6</sup> Shall be met when tested in a suitable enclosure

# CLP0112 Open Frame Power Supply

90 - 265Vac input; 12Vdc output; 150W Output Power

## Characteristic Curves

The following figures provide typical characteristics for the CLP0112 power supply

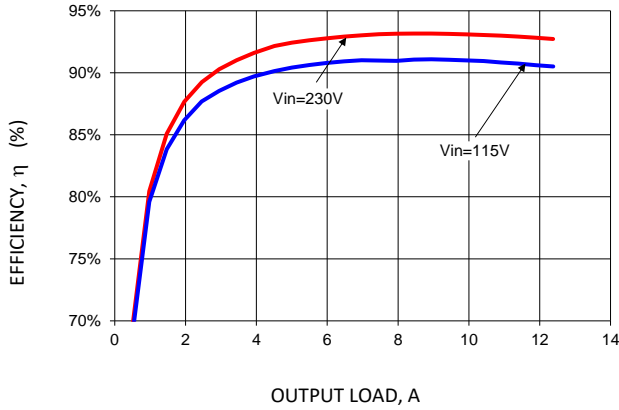

Figure 1. Power Supply Efficiency versus Output Current.

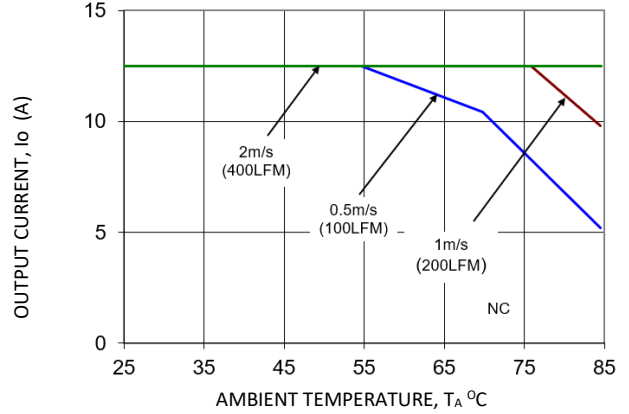

Figure 2. Derating Output Current versus Ambient Temperature and Airflow. Data shown for 115VAC in, at 230VAC in derating is the same or better. For derating at other input voltages, consult the GE Technical representative.

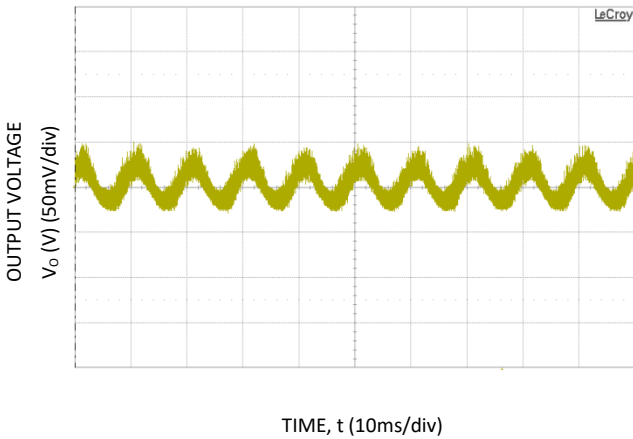

Figure 3. Typical output ripple and noise (VIN = 230Vac, 100% load).

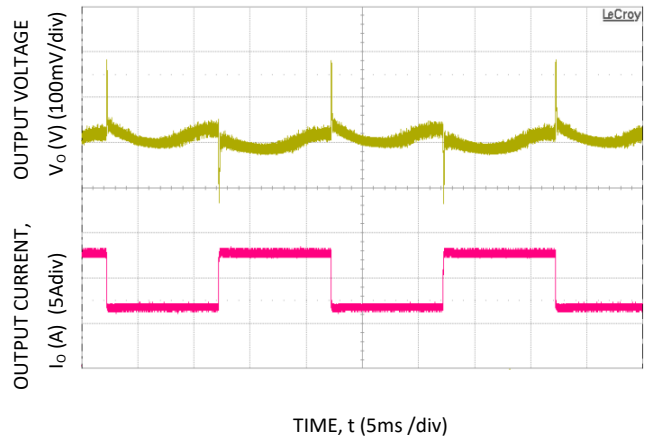

Figure 4. Transient Response to Dynamic Load Change from 50% to 100% at Vin = 230Vac.

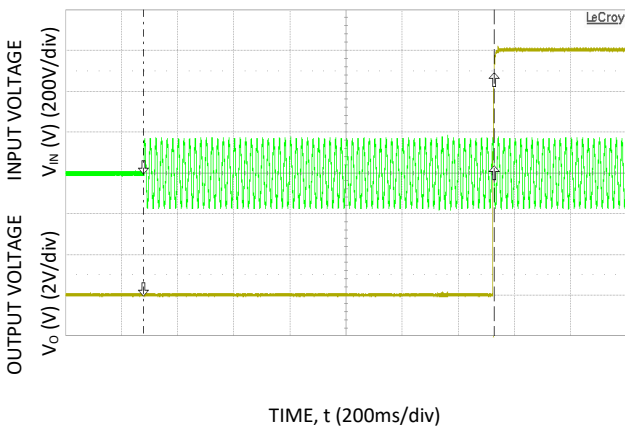

Figure 5. Typical Start-up (VIN = 115Vac).

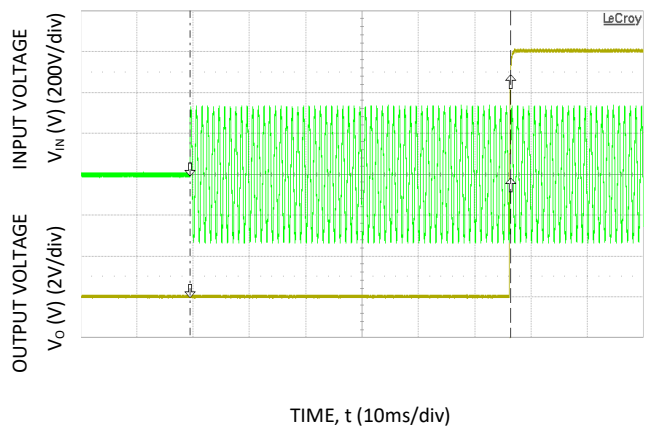
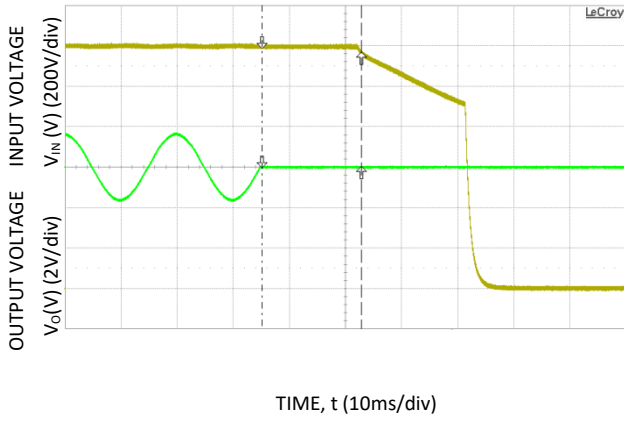

Figure 6. Typical Start-up (VIN = 230Vac)

**CLP0112 Open Frame Power Supply**  
 90 - 265Vac input; 12Vdc output; 150W Output Power

**Characteristic Curves (cont.)**

The following figures provide typical characteristics for the CLP0112 power supply



**Figure 7. Typical Hold-up waveforms ( $V_{IN} = 115V$ , 100% load).**

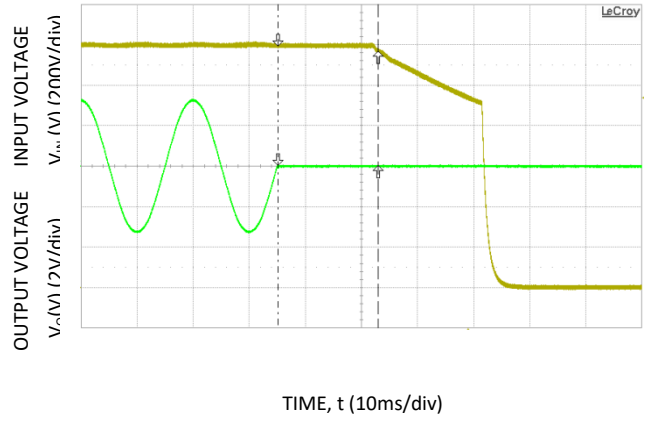

**Figure 8. Typical Hold-up waveforms ( $V_{IN} = 230V$ , 100% load).**

## CLP0112 Open Frame Power Supply

90 - 265Vac input; 12Vdc output; 150W Output Power

### Safety Considerations

The CLP0112 power supply is intended for inclusion in other The CLP0112 power supply is intended for inclusion in other equipment and the installer must ensure that it is in compliance with all the requirements of the end application. This product is only for inclusion by professional installers within other equipment and must not be operated as a stand-alone product. The power supply meets Class 1, IEC62368-1, EN62368-1, with the following deviations: Nemko UL(Recognized Component) C-UL (Canadian Approval by UL).

### Feature Descriptions

#### Overcurrent Protection

To provide protection in a fault condition (output overload), the power supply is equipped with internal current-limiting circuitry and can endure current limiting continuously. At the point of current-limit inception, the unit enters hiccup mode. The power supply operates normally once the output current is brought back into its specified range.

#### Overvoltage Protection

Overvoltage protection is a feature of the CLP0112 power supply that protects both the load and the power supply from an output overvoltage condition. When an overvoltage occurs, the power supply shuts down and latches off. It is then necessary to recycle the input to restart the power supply when this protection is activated.

#### Overtemperature Protection

The CLP0112 also features overtemperature protection in order to provide additional protection in a fault condition. The power supply is equipped with a thermal shutdown circuit which detects excessive internal temperatures and shuts the unit down. Once the power supply goes into overtemperature shutdown, it will cool before attempting to restart. The overtemperature protection circuit will typically activate when the unit is operated at 150W output with an ambient temperature of 80°C and 1m/s (200LFM) airflow. Please note that at ambient temperatures of 75°C or higher and very low airflow conditions, the unit may need to have input voltage recycled before it turns back on from an OTP fault.

#### Input Undervoltage Lockout

At input voltages below the input undervoltage lockout limit, power supply operation is disabled. The power supply will begin to operate at an input voltage above the undervoltage lockout turn-on threshold. Note that the undervoltage lockout limits are load dependent and the power supply turns ON and can operate at much lower input voltage levels when at light or no load.

### Output Voltage Adjustment

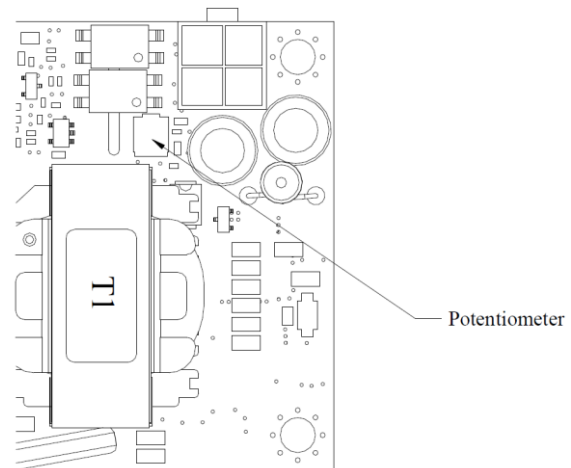

**Fig. 9. Diagram showing location of the potentiometer used to adjust the power supply output voltage.**

The output voltage can be adjusted between 11.7V and 12.6V using a potentiometer on the power supply. See Fig. 9 for a diagram showing location of the potentiometer.

### Unique features in Z02A version

Z02A version has conformal coating (1mil thickness), and has passed environmental tests such as: salt fog test and mixed flow gas testing based on the following standards:

Mixed flow gas test Standard:  
Telcordia GR-3108-CORE per R16-18[111], Outdoor Level, 14-Day (Mixed Flowing Gas)

Salt fog test standard:  
IEC 60068-2-52

### Unique features in Z03A version

Z03A version has a fuse on Neutral wire in addition to the fuse on the Live Wire. Besides the extra fuse, the orientation of the output connector in Z03A is different from that in Z01A/Z02A. Please refer to mechanical outline.

# CLP0112 Open Frame Power Supply

90 - 265Vac input; 12Vdc output; 150W Output Power

## Thermal Considerations

The power supply can be operated in a variety of thermal environments; however sufficient cooling should be provided to ensure reliable operation.

Considerations include ambient temperature, airflow, power supply dissipation and the need for increased reliability. A reduction in the operating temperature of the power supply will result in increased reliability. The thermal data presented here is based on measurements taken in a wind tunnel.

## Heat Transfer via Convection

Increased airflow through the power supply enhances the heat transfer via convection. Figure 10 shows the preferred airflow direction. Contact your GE technical representative for derating information in other airflow directions.

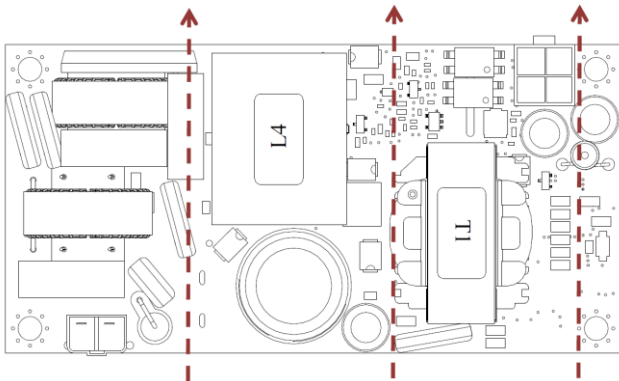

Fig. 10. Preferred airflow direction for cooling.

## Operation in a Sealed Enclosure

The CLP0112 power supply can also be operated in a sealed enclosure provided proper means for removing heat from the power supply are used. Figure 11 shows an arrangement where a thermally conductive pad is used to transfer heat from the bottom of the power supply into the enclosure. Under such conditions, the power supply is capable of reduced power operation as shown in Table 1. Note that the Ambient Temperature shown in Table 1 is that outside the sealed enclosure, the CLP0112 may see higher ambient temperatures.

Table 1. Output Power Capability when the CLP0112 is operated in a sealed enclosure with thermal pad for conduction cooling.

| Ambient Temperature (°C) | Max. Output Power (W) |
|--------------------------|-----------------------|
| 25                       | 150                   |
| 40                       | 150                   |
| 55                       | 130                   |

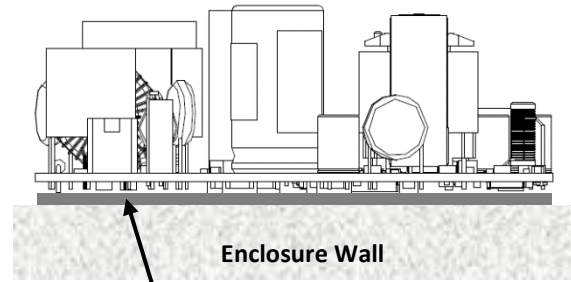

Thermally Conductive Pad

Fig. 11. Example arrangement of the CLP0112 for sealed enclosure applications.

Thermal conductivity should be 3.0 W/m-K for thermal pad application and 1kV+ isolation, example:

**Thermal gap pad:**

[http://www.bergquistcompany.com/pdfs/dataSheets/PDS\\_GP\\_HC3\\_0714%20v7.pdf](http://www.bergquistcompany.com/pdfs/dataSheets/PDS_GP_HC3_0714%20v7.pdf)

**Thermal gap pad:**

<https://www.lairdtech.com/products/tpatty-502>

## Assembling

- Please use metal screw to mount the unit and make sure 4 mounting holes connected to Earth well.
- In Applications where the power supply is enclosed, special attention to clearances between the supply and the enclosure should be a min. 3.5mm on all sides for improved safety. **For additional protection, a layer of Kapton tape (3 mil thickness), covering the whole surface under the supply is recommended.** If a cover is used a 3 mil Kapton Tape covering the whole cover is also recommended. Please contact your local ABB FAE if further information is need.

# CLP0112 Open Frame Power Supply

90 - 265Vac input; 12Vdc output; 150W Output Power

## Mechanical Outline

Dimensions are in millimeters.  
 Tolerances: x.x mm ± 0.5mm [unless otherwise indicated]  
 x.xx mm ± 0.25mm

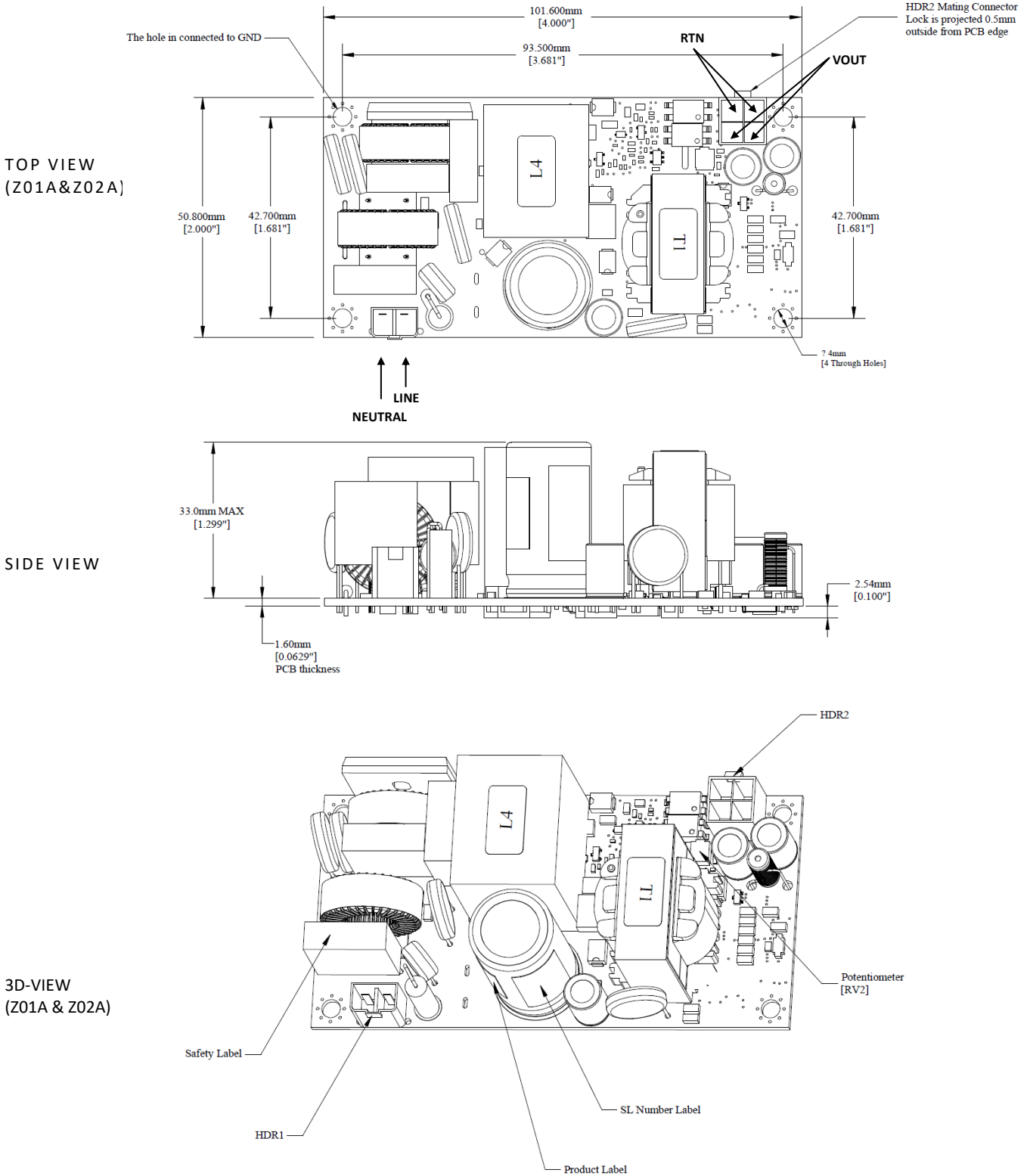



# CLP0112 Open Frame Power Supply

90 - 265Vac input; 12Vdc output; 150W Output Power

TOP VIEW  
(Z03A)

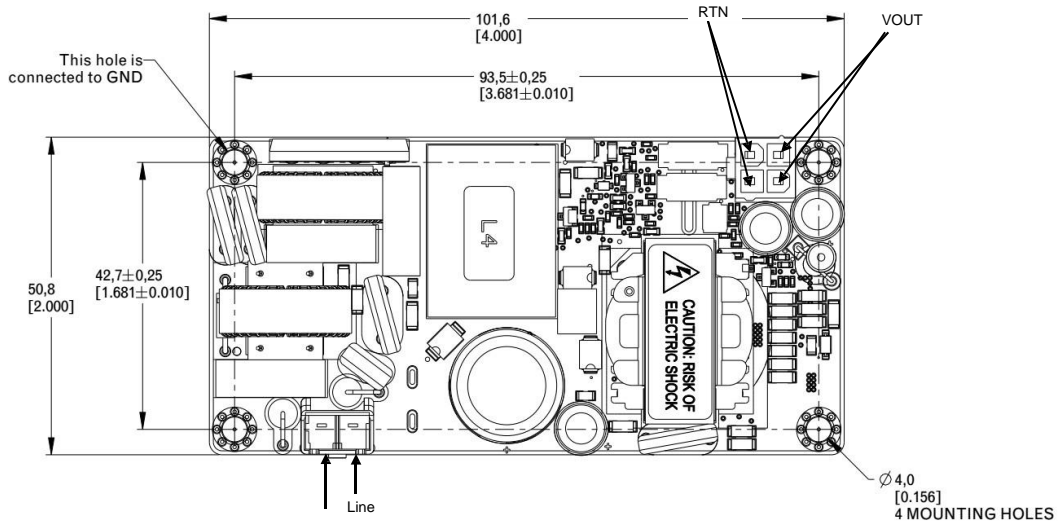

**CLP0112 Open Frame Power Supply**  
 90 - 265Vac input; 12Vdc output; 150W Output Power

**Connector Information**

| Connector                  | Connector on Power Supply           | Mating Connector                    |
|----------------------------|-------------------------------------|-------------------------------------|
| AC Input Connector (HDR1)  | 5-1376382 from TE or equivalent     | 1376388-1 from Tyco or equivalent   |
| DC Output Connector (HDR2) | 39-28-8040 from Molex or equivalent | 39-01-3048 from Molex or equivalent |

**Pinout Information**

| AC Input Connector (HDR1) |         | DC Output Connector (HDR2) |     |
|---------------------------|---------|----------------------------|-----|
| Pin 1                     | Line    | Pin 1                      | VO  |
| Pin 2                     | Neutral | Pin 2                      | VO  |
|                           |         | Pin 3                      | RTN |
|                           |         | Pin 4                      | RTN |

## CLP0112 Open Frame Power Supply

90 - 265Vac input; 12Vdc output; 150W Output Power

### Ordering Information

Please contact your GE Sales Representative for pricing, availability and optional features.

**Table 2. Device Codes**

| Device Code   | Input Voltage Range | Output Voltage | Output Current | Temperature Range | Comcode          |
|---|---------------------|----------------|----------------|-------------------|------------------|
| CLP0112FPXXXZ01A  | 90 – 265Vac         | 12.0Vdc        | 12.5A          | -40 to 85°C       | 150039432        |
| CLP0112FPXXXZ02A<br>(conformal coated)                            | 90 – 265Vac         | 12.0Vdc        | 12.5A          | -40 to 85°C       | CLP0112FPXXXZ02A |
| CLP0112FPXXXZ03A<br>(Dual Fuse Version.<br>Added fuse in Neutral) | 90 – 265Vac         | 12.0Vdc        | 12.5A          | -40 to 85°C       | CLP0112FPXXXZ03A |

## Contact Us

For more information, call us at

USA/Canada:

**+1 877 546 3243**, or +1 972 244 9288

Asia-Pacific:

**+86-21-53899666**

Europe, Middle-East and Africa:

**+49.89.878067-280**

[Go.ABB/Industrial](http://Go.ABB/Industrial)



GE Critical Power reserves the right to make changes to the product(s) or information contained herein without notice, and no liability is assumed as a result of their use or application. No rights under any patent accompany the sale of any such product(s) or information.