

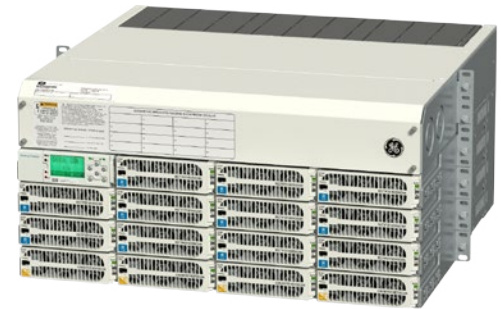

Infinity B Power System

Dual Voltage, Universal Bulk Power System



Overview

The GE Infinity B DC energy system is a universal bulk power plant that supports dual voltage (+24V/-48V) operation through the use of a comprehensive range of advanced rectifiers and DC-DC converters. Primary voltage is supported by rectifiers and battery reserve, while secondary voltage is supported by DC-DC converter modules. Primary voltage can be -48V or +24V. The bulk output panel is capable of connecting two 750 MCM and two 4/0 cables per polarity. Output can be routed top or bottom.

The Infinity B Power System has primary voltage capacity for +24V power up to 1,600A and -48V power up to 1,200A; secondary voltage capacity is up to 600A based on input capacity.

Shelf / Bay Options

Infinity B systems may be equipped in a 7 ft 23" relay rack; a half height rack for mounting on battery stands; or mounting rails for field install applications. The compact size is as little as 6U (10.5") tall and 20.2" deep. Universal shelves are 1U tall with four slots that accept any Infinity series rectifier or converter.

Infinity Rectifier and Converter Family

The Infinity Series offers DC rectifiers and converters for both +24V to -48V and -48V to +24V applications. For easy module selection, the rectifiers and converters are color coded to quickly identify voltage, module type and input voltage type (AC or DC).

Galaxy Pulsar* Plus Controller

The Galaxy Pulsar Plus is used throughout many of the GE DC Power products including Infinity, CP, and SPS with the only differentiator being the form factor which is scaled to meet the nature of the application. The controller utilizes standard network management protocols allowing for advanced network supervision with SNMP communications to deliver extensive monitoring and control features with both local and remote access.

Advantages

- Dual Voltage power system with ultimate flexibility
- -48V up to 1,200A (65KW) or +24V up to 1,600A (44KW)
- Secondary voltage up to 600A
- High availability wireless telecom applications
- Telecom service providers
- Efficiency approaching 97%

Infinity Rectifiers and Converters

- Compact – 1RU form factor providing high power density (24 W/in³)
- Dual Voltage compatibility – the unique connector pin designation allows the rectifier to be used in a “universal” power shelf, alongside rectifiers or DC-DC converters with different output voltages.
- Plug and Play – installation of the rectifier in a shelf connected to a compatible system controller initializes all set up parameters automatically. No adjustments are needed.
- Extended service life – parallel operation with automatic load sharing ensures that parallel units are not unduly stressed even when a unit fails or is removed.
- Monitoring / control – the built in microprocessor controls and monitors all critical rectifier functions and communicates with the system controller using the built in Galaxy Protocol serial interface.
- Fail safe performance – hot insertion capabilities allow for converter replacement without system shutdown; soft start and inrush current protection prevent nuisance tripping of upstream breakers.



Applications

- Telecommunications Networks
- Digital Subscriber Line (DSL)
- Indoor/Outdoor Wireless
- Routers/Switches
- Fiber in the Loop
- Transmission
- Data Networks
- Distributed Antenna Systems
- Off-Grid/On-Grid Renewable Energy Sites

Key Features

- Extended temperature range
- Redundant fan cooling
- Front panel LED indicators
- 1U height, hi power density
- 220/110V AC input
- Digital load sharing
- Hot pluggable
- RoHS compliant
- Direct solar input (no inverter required)

Specifications

| INPUT | NE100AC24ATEZ NE100ECO24ATEZ | NE050AC48ATEZ NE050ECO48ATEZ | NE075AC48ATEZ | NE030DC48A | NE040DC48A | NE075DC24A |
|---------------------------|--|--|--|----------------------------|-----------------------------|------------------------------|
| Voltage Range | 95-275Vac | 95-275Vac | 95-305Vac | 21-30Vdc | 21-30Vdc | 42-60Vdc |
| Input Current | 15-12A @ 100-120Vac 15-12A @ 200-240Vac | 15-12A @ 100-120Vac 15-12A @ 200-240Vac | 15-12A @ 100-120Vac 22-15.5A @ 200-277Vac | 63A @ 27Vdc 81A @ 21Vdc | 94A @ 27Vdc 108A @ 21Vdc | 41A @ 54.5Vdc 54A @ 42Vdc |
| Input Frequency | 45 – 66Hz | 45 – 66Hz | 45 - 66Hz | - | - | - |
| Power Factor | 0.98 at>50% load | 0.98 at>50% load | 0.98 at>50% load | - | - | - |
| Efficiency | > 95% (Peak 95.6%) | > 96% (Peak 96.9%) | > 96% (Peak 96.9%) | - | - | - |
| Total Harmonic Distortion | <5% @loads over 50% | <5% @loads over 50% | <5% @loads over 50% | - | - | - |

Specifications (Cont.)

| OUTPUT | NE100AC24ATEZ NE100ECO24ATEZ | NE050AC48ATEZ NE050ECO48ATEZ | NE075AC48ATEZ | NE030DC48A | NE040DC48A | NE075DC24A |
|---|---------------------------------|---------------------------------|--------------------------|-------------------|-------------------|-------------------|
| Voltage Adjust Range | 21-29Vdc | 42-58Vdc | 42-58Vdc | 46-57Vdc | 46-57Vdc | 23-28Vdc |
| Voltage Nominal | 27.25V | 54.5V | 54.5V | 52.0V | 52.0V | 27.2V |
| Regulation (with controller) | ±0.5% | ±0.5% | ±0.5% | ±0.5% | ±0.5% | ±0.5% |
| Ripple | 100mVrms | 100mVrms | 100mVrms | 100mVrms | 100mVrms | 100mVrms |
| Output Current | | | | | | |
| - High-Line | 114A @24V | 57A @48V | 82A@48V | 30A @52.0V | 40A @52.0V | 75A @27.2V |
| - Low-Line | 100A @27.25V 44A @27.25V | 50A @54.5V 22A @54.5V | 75A @54.5V 22A @54.5V | - - | - - | - - |
| Heat Dissipation @ max out ¹ | 174W / 594 BTU/hr | 158W / 539 BTU/hr | 249W / 850 BTU/hr | 154W / 525 BTU/hr | 205W / 700 BTU/hr | 202W / 689 BTU/hr |

¹ Special room cooling may be required.

ENVIRONMENTAL

| | |
|-----------------------|---|
| Operating Temperature | -40°C to +75°C (-40°F to 167°F) Full capacity up to 55°C; output derates 2%/°C from 55°C to 75°C |
| Storage Temperature | -40°C to +85°C (-40°F to 185°F) |
| Humidity | < 95% non-condensing |
| Altitude | 4000M (for altitudes above 2000M, peak operating temperature de-rates 0.656° C /100M; 4000M peak temperature rating is 62°C |

MECHANICAL

| | |
|------------------|---------------|
| Length (inch/mm) | 13.85 / 351.8 |
| Width (inch/mm) | 5.23 / 133 |
| Height (inch/mm) | 1.63 / 42 |
| Weight (lb/Kg) | 5.05 / 2.2 |

SAFETY AND STANDARDS COMPLIANCE

| | |
|--------------|---|
| NEBs Level 3 | Evaluated by independent NRTL test lab to Telcordia GR63-CORE and GR1089-CORE [Level 3] |
| Safety | CE mark to Low Voltage Directive 2006/95/EC and EMC Directive 2004/108/E (Rectifiers only) UL 60950-1, 2nd Ed. Recognized CSA C22.2 No. 60950-1-07, 2nd Ed. + A1:2001 (MOD) |
| RoHS | Compliant to RoHS EU Directive 2002/95/EC; RoHS 6/6 models with Z suffix (RoHS 5/6 all other models) |
| EMC | European Directive 2004/108/EC; EN55022, Class A; EN55024; FCC, Class A; GR1089-CORE |
| ESD | EN61000-4-2, Level 4 |

OUTLINE DRAWINGS

Pulsar Plus Controller

The Pulsar Plus family of controllers provides system monitoring and control features for Infinity, CP, and other power systems. These controllers monitor and control system components including rectifiers, converters, and distribution modules via a multi-drop RS485 digital communications bus. System status, parameters, settings, and alarm thresholds can be viewed and configured from the controller's front panel display. Assignment and configuration of alarm inputs and output relays can be



performed from a laptop computer connected to a local RS-232 or Ethernet port, or by remote access is through a network connection to the World Wide Web (internet) or your enterprise network (intranet). An optional modem is also available.

This controller utilizes standard network management protocols allowing for advanced network supervision. GE Galaxy Manager™ software is the centralized visibility and control component of a comprehensive power management system designed to meet engineering, operations and maintenance needs. The Galaxy Manager client-server architecture enables remote access to system controllers across the power network, featuring ECO Priority advanced monitoring features which provides detailed energy source analysis to help better customize your renewable energy resources.

Applications

- Telecommunications Networks
- Digital Subscriber Line (DSL)
- Indoor/Outdoor Wireless
- Routers/Switches
- Fiber in the Loop
- Transmission
- Data Networks
- PBX
- Off-Grid/On-Grid Renewable Energy Sites

Specifications

| GENERAL | |
|-----------------------------|---|
| Operating Voltage | ±24 Vdc, ±48 Vdc (Range: ±18 to ±60 Vdc) |
| Input Power | Less than 7W |
| Operating Temperature Range | -40°C to +75°C (-40°F to 167°F) |
| Operating Relative Humidity | 0 - 95% (non-condensing) |
| Storage Temperature Range | -40°C to +85°C (-40°F to 185°F) |
| Physical Specifications | Sizes vary by packaging option |
| Display | 8-line by 40-character with alarm context sensitive backlit LCD |

| SAFETY AND STANDARDS COMPLIANCE | |
|---------------------------------|--|
| NEBs | Evaluated by independent NRTL test lab to Telcordia GR63-CORE and GR1089-CORE [Level 3] |
| Safety | CSA C22.2 No. 60950-1-07, 2nd Ed. + A1:2001 (MOD) Certified for Canada and U.S.; UL60950-1 2nd Ed. |
| RoHS | Compliant to RoHS EU Directive 2002/95/EC RoHS 5/6 |
| EMC | European Directive 2004/108/EC; EN55022, Class A, EN55024; FCC, Class A; GR1089-CORE |

| AGENCY CERTIFICATIONS | |
|-----------------------|---|
| NEBs Level 3 | Evaluated by independent NRTL test lab to Telcordia GR63-CORE and GR1089-CORE [Level 3] |
| EMC | European Directive 2004/108/EC; EN55022, (CISPR22) Class A, EN55024 (CISPR24) |
| Safety | Underwriters Laboratories (UL) Listed per Subject Letter 1801: Power Distribution Center for Communications Equipment, and cUL Certified (CSA 22.2 950): Safety of Information Technology Equipment |

Key Features

Remote Access and Features

- Integrated 10/100Base-T Ethernet Network
 - TCP/IP
 - SNMP V2c for management
 - SMTP for email
 - Telnet for command line interface
 - DHCP for plug-n-play
 - FTP for rapid backup and upgrades
 - HTTP for standard web pages and browsers
 - Compatible with Galaxy Manager and other management packages
 - Shielded RJ-45 interface referenced to chassis ground
- Password protected security levels: User, Super-User, Administrator for all access
- Ground-referenced RS232 system port
- ANSI T1.317 command-line interface
- Modem access support
 - Remote via external modem
 - Callback security
- EasyView2, Windows-based GUI software for local terminal or Modem access
- ECO Priority controls and features
 - Advanced generator controls to help minimize fuel consumption for off grid applications
 - ECO Energy Management allowing for non-ECO sources outputs to be minimized while ECO resources are available
- Source and load trend logging

Standard System Features

- Monitor and control of more than 60 connected devices
 - Robust RS485 system bus
- Standard and user defined alarms
 - Alarm test
 - Assignable alarm severity: Critical, Major, Minor, Warning, and record-only
 - 10 alarm relays (7 user assigned)
- Rectifier management features
 - Automatic rectifier restart
 - Active Rectifier Management ARM (energy efficiency)
 - Remote rectifier (on/off)
 - Reserve Operation
 - Automatic rectifier sequence control
 - N + X redundancy check
- Multiple Low Voltage Load and Low Voltage Battery Disconnect thresholds
- Configuration, statistics, and history
 - All stored in non-volatile memory
 - Remote/local backup and restore of configuration data
- Industry standard defaults
 - Customer specific configurations available
- Remote/ local software upgrade
- Basic, busy hour, and trend statistics
- Detailed event history
- User defined events and derived channels

Standard Battery Management Features

- Float/boost mode control
 - Manual boost
 - Manual timed boost locally, T1.317, and remotely initiated
 - Auto boost terminated by time or current
- Battery discharge testing
 - Manual (local/remote)
 - Periodic
 - Plant Battery Test (PBT) input driven
 - Configurable threshold or 20% algorithm
 - Graphical discharge data
 - Rectifiers on-line during test
- Slope thermal compensation
 - High temperature
 - Low temperature
 - Step temperature
 - STC Enable/Disable, low temperature Enable/Disable
 - Configurable mV/°C slopes
- State of charge indication
- High temperature disconnect setting
- Reserve-time prediction
- Recharge current limit
- Emergency Power-Off input

Integrated Monitoring Inputs/Outputs

- System plant voltage (accuracy $\pm 0.04V$, resolution 0.01V)
- One system shunt (accuracy $\pm 0.5\%$ full scale, resolution 1A)
 - Battery or load
 - Mounted in the return side of DC bus
- Up to 15 binary inputs
 - Six inputs close/open to battery
 - 9 input close/open to return
 - User assignable
- Up to 7 Form-C output alarms (60VDC @ .5A)
 - User assignable
- 1-Wire™ bus devices
 - Up to 16 temperature probes (QS873)
 - Up to 6 mid-string monitors (ES771)

Galaxy Manager Compatible

- Centralized web server and database with multiple user access to live or managed data with drill down to problem details
- Monitor and control of more than 40 connected devices
- Management information from polling or alarms received from alarm traps from multiple sites are available on one screen via the inter/intranet
- Trend user selected data over time
- Automatic or manual report generation
- Standard engineering tools like reserve time calculators and cable voltage drop analyzer

Galaxy Millennium* II Controller



Galaxy Millennium II is our flagship controller designed to meet the needs of the most advanced power systems. Building on the Galaxy Millennium platform, the Galaxy Millennium II delivers state-of-the-art performance by combining sophisticated control, monitoring, and remote network access previously on three separate circuit packs into a single integrated unit. The

controller has been designed to simplify plant administrative and surveillance routines as well as reduce operating, provisioning, and personnel expenses.

Configuration of the Galaxy Millennium II can be performed via menu based front panel display, a local terminal or remote modem using EasyView2, or through a local or remote network connection utilizing standard web browsers or network protocols. In addition to its standard integrated monitoring capabilities, this controller offers extensive external monitoring using bay interface cards (BICs), distribution control cards, and remote peripheral monitoring modules (RPMs) designed for various

inputs and transducers. Additional external relay contacts are also available.

The Galaxy Millennium II, with integrated network access, allows for advanced network supervision using standard network management protocols and available network management software. The GE Energy Galaxy Manager network management software can be used to meet power system engineering, operations and maintenance needs. Via the World Wide Web, users gain access to live data and information logged into Galaxy Manager's centralized server from each monitored system controller across the power network.

Applications

- Infinity NE-M
- CPS6000-M2
- GPS 4848/100
- Galaxy Vector controller upgrades
- GPS 4812/24
- GPS 2424
- Stand-alone monitoring applications
- Galaxy Millennium upgrades & replacements

Key Features

Remote Access and Features

- Integrated 10/100Base-T Ethernet Network capability
 - TCP/IP
 - SNMP Version 2c for remote management
 - SMTP for email
 - Telnet for remote command line interface
 - TL-1
 - DHCP for network plug-n-play
 - FTP for rapid backup and upgrades
 - HTTP for standard and custom web pages for standard browsers
 - Compatible with Galaxy Manager and other standard network management packages
 - Standard shielded RJ-45 interface referenced to chassis ground
- Optional Dataswitch
 - Connections to 3 standard RS-232 devices for pass-through and alarm management
 - BSN extension to provide 3 additional RS-232 serial connections
- Configurable RS-232/485 port for remote via TL1/X.25
- EasyView2, Windows-based software, for configuration and reporting through local terminal or Modem connections
- Multiple password-protected security levels: User, Super-User, Administrator for all access

Standard System Features

- Monitoring and control of up to 85 RS485 serial connected devices
 - Maximum of 85 serial switchmode rectifiers
 - Maximum of 32 bay interface cards (BICs)
 - Maximum of 16 serial converters
- Standard and custom User Defined system alarms
 - Alarm cut-off
 - Alarm test
 - Multiple-level alarm severity: Critical, Major, Minor, Warning, and record-only
- Standard rectifier management features
 - Automatic rectifier restart
 - Reserve engine transfer
 - Adaptive Rectifier Management (ARM)/Energy Efficiency
 - Remote rectifier (on/off) control
 - Automatic rectifier sequence control
 - N + X redundancy check
- Low Voltage Load and Low Voltage Battery Disconnect Options (3)
- Various levels of configuration, statistics, and history
 - All stored in non-volatile memory
 - Remote and local backup and restore of configuration data
- Remote and local software upgrade
- Basic, busy hour, and trend statistics kept
- Detailed history kept
- Maintenance reminders
- Inventory management
- User defined events and derived channels
- Hardware DIP switch access control

Standard Battery Management Features

- Float/boost mode control
 - Manual front panel boost
 - Manual timed boost locally, T1.317, and remotely initiated
 - External timed boost
 - Battery thermal protect module (BTP)
 - Auto boost terminated by time or current
- Battery discharge testing
 - Manual
 - Periodic
 - Plant Battery Test (PBT) input driven
- Slope thermal compensation
 - High temperature compensation
 - Low temperature compensation
 - Step temperature
 - STC Enable/Disable, low temperature Enable/Disable
 - mV/°C adjustments
- High temperature disconnect/step setting
- Sophisticated reserve-time prediction
 - User configurable system reserve low alarm during normal operation
 - User configurable reserve time low alarm
- Recharge current limit
- Integrated "At Rate Calculator" for estimation purposes
- Battery discharge trace data
- Emergency Power-Off Input
- Lithium battery fail input

Features

Integrated Outputs

- Traditional office alarm interface with 19 Form-C alarm outputs (60VDC @.3A)
 - Standard default assignments: Power Critical-Audio, Power Critical-Visual, Power Critical-External, Power Major-Audio, Power Major-Visual, Power Major-External, Power Minor-Audio, Power Minor-Visual, Power Minor-External, Major Fuse (MJF), Minor Fuse (MNF), Battery On Discharge (BD), AC Fail (ACF), Rectifier Fail, High Voltage (HV), Very Low Voltage (VLV), Controller Fail, User Relay 1, User Relay 2
 - 16 Form-Cs are user assignable
- 1 1/3A Auxiliary Battery Supply (ABS) Output

Remote Peripheral Monitoring & Control

- Modular monitor and control growth options for up to 95 monitoring modules optimized for DC voltage and shunt monitoring, binary input detection, temperature monitoring, external transducer monitoring
- Additional Form-C relay output control available
- Devices managed and powered by the controller via one twisted-pair cable over distances of 300m or more
- Daisy-chain connections from module to module reduce installation costs and cable congestion
- Modules can be located near monitored source
- Various panels for rack-mounting available

Enhanced Battery Management Features

- Battery discharge test options including periodic and manual tests (local/ remote) with configurable thresholds or 20% discharge algorithm
- State of charge indication
- Rectifiers on-line during test (minimize risk to service)
- Discharge data stored in non-volatile memory. Graphical data available

- Accurate battery reserve time calculations that factor in battery specific parameters, plant voltage, load, temperature, number of battery strings and number of cells per string
- Thermal compensation (STC) and recharge current limit to maximize battery life

Extensive Plant and Monitoring Statistics

- Real-time data and historical statistics help analyze critical performance parameters
- Statistics for planning preventive or corrective maintenance before serious problems occur

Derived Channels

- 32 derived channels enable arithmetic and Boolean operations to be performed on measured values to allow customer specific parameters such as output power to be calculated and managed

Rectifier Management

- Energy Efficiency, provides ability to automatically shutdown selected rectifiers during low plant loads maintaining maximum battery plant efficiency without sacrificing reliability
- Provides Reserve Operation feature for maintaining designated number of rectifiers on during Engine runs as well as proper sequencing for generators
- Provides ability to transfer rectifiers (TR1-TR4) on in certain sequences for return of AC

Galaxy Manager Compatible

- Centralized web server and database with multiple user access to live or managed data with drill down to problem details
- Monitor and control of more than 40 connected devices
- Management information from polling or alarms received from alarm traps from multiple sites are available on one screen via the inter/intranet
- Trend user selected data over time
- Automatic or manual report generation
- Standard engineering tools like reserve time calculators and cable voltage drop analyzer

Specification

| GENERAL | |
|-----------------------------|---|
| Operating Voltage | ± 24Vdc, ± 48Vdc (Range: ± 18 to ± 60Vdc) |
| Input Power | 36W (depending on options) |
| Operating Temperature Range | -40°C to +75°C (-40 to 167°F) |
| Storage Temperature Range | -40°C to +85°C (-40 to 185°F) |
| Operating Relative Humidity | 0 - 95% (non-condensing) |
| Physical Specifications | 9.24" H x 20.76" W x 2.14" D |
| Display | 8-line by 40-character backlit LCD |

| AGENCY CERTIFICATIONS | |
|-----------------------|---|
| NEBs | Evaluated by independent NRTL test lab to Telcordia GR63-CORE and GR1089-CORE [Level 3] |
| EMC (Emissions) | FCC and EN 55022, Class B; FCC, Class B; GR1089-CORE |
| Safety | UL Listed Component as Part of GPS Power System |

Infinity B System

AC Input

| RECTIFIER (A) | MODEL NUMBER OF RECTIFIER | RATED INPUT VOLTAGE | NUMBERS OF RECTIFIERS PER AC FEED | NOMINAL AC CURRENT (A) | MINIMUM CIRCUIT BREAKER VALUE RECOMMENDED(A)* | 75 C MINIMUM RECOMMENDED WIRE GAUGE (AWG)* |
|---------------|---------------------------|---------------------|-----------------------------------|------------------------|---|--|
| 100A | NE100AC24ATEZ | 200 | 1 | 14.5 | 20 | 14 |
| | | 200 | 2 | 29.0 | 40 | 10 |
| 50A | NE050AC48ATEZ | 200 | 1 | 14.4 | 20 | 14 |
| | | 200 | 2 | 28.8 | 40 | 10 |
| 75A | NE075AC48ATEZ | 200 | 1 | 21.8 | 30 | 12 |
| | | 200 | 2 | 43.6 | 60 | 8 |

Specifications

| INPUT | MIN | TYP | MAX |
|--|-----------------|------------------|------------------|
| Voltage Range - High-Line - Low-Line | 175Vac 85Vac | 220Vac 110Vac | 305Vac 140Vac |
| Frequency | 45Hz | 60Hz | 66Hz |
| Power Factor | 98% | 99.5% | |
| Total Harmonic Distortion | | | 5% |

| PRIMARY INPUT | | |
|-----------------------|--|--|
| Nominal Voltage | 24Vdc | -48Vdc |
| Output Current | 1,600A Single Voltage 1,200A Dual Voltage | 1,200A Single Voltage 900A Dual Voltage |
| Vo Setpoint (factory) | 27.2Vdc±1% | -54.5Vdc±1% |
| Vo Range | +21Vdc to +29Vdc | -42Vdc to -58Vdc |
| Regulation | ±0.5% | |

| SECONDARY OUTPUT ¹ | | |
|-------------------------------|------------------|------------------|
| Nominal Voltage | -48Vdc | 24Vdc |
| Output Current | 160A | 300A |
| Vo Setpoint (factory) | -54.5Vdc±1% | 27.2Vdc±1% |
| Vo Range | -42Vdc to -58Vdc | +21Vdc to +29Vdc |
| Regulation | ±0.5% | |

¹ These are secondary output levels when using only one shelf of converters. Please contact your technical consultant for additional configurations.

Specifications (Cont.)

| MECHANICAL | |
|------------------|---------------------|
| Height (in. /mm) | 10.5 inches / 266mm |
| Width (in. /mm) | 23 inches / 584mm |
| Depth (in. /mm) | 20.2 inches / 514mm |
| Weight (lb / Kg) | 56lbs / 25.4kg |

| ENVIRONMENTAL | |
|-----------------------|---|
| Operating Temperature | -40°C to +75°C (-40°F to 167°F) |
| Storage Temperature | -40°C to +85°C (-40°F to 185 °F) |
| Relative Humidity | 95% max, non-condensing |
| Altitude | 4000M (for altitudes above 2000M, peak operating temperature de-rates 0.656° C /100M; 4000M peak temperature rating is 62° C) |

| SAFETY AND STANDARDS COMPLIANCE | |
|---------------------------------|--|
| NEBs | Evaluated by independent NRTL test lab to Telcordia GR63-CORE and GR1089-CORE [Level 3] |
| Safety | CSA C22.2 No. 60950-1-07, 2nd Ed. + A1:2001 (MOD) Certified for Canada and U.S.; UL60950-1 2nd Ed. |
| RoHS | Compliant to RoHS EU Directive 2002/95/EC RoHS 5/6 |
| EMC | European Directive 2004/108/EC; EN55022, Class A; EN55024; FCC, Class A; GR1089-CORE |

| AGENCY CERTIFICATIONS | |
|-----------------------|--|
| CSA | CSA C22.2 No 60950-1-07, 2nd Ed. + A1:2001 (MOD) and UL 60950-1 2nd Ed |
| EMI/EMC | European Directive 2004/108/EC; EN55022 (CISPR22) Class A; EN55024 (CISPR24) |
| NEBS LEVEL 3 | GR1089-CORE Special equipment room cooling may be needed - heat dissipation exceeds values of GR-63 Table 4-5 |

OUTLINE DRAWINGS

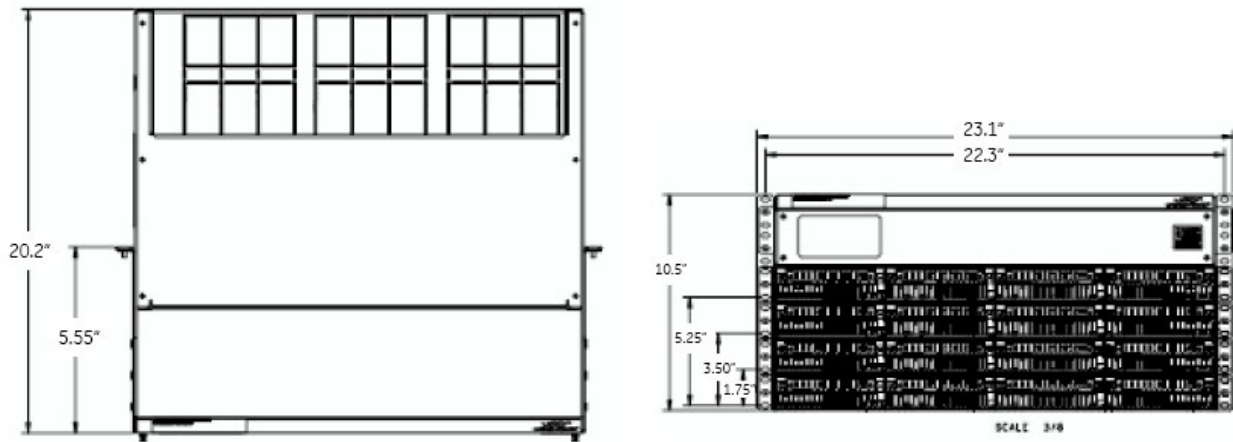

Shelf Specifications

| MECHANICAL | |
|-----------------------------|---|
| Height | 4RU main cabinet plus 1RU per power shelf – Base system 5RU (8.75 inches / 222mm) |
| Width (with mounting ears) | 23 inches (584mm) |
| Depth | 18 inches (457mm), 21 inches (533mm) for systems equipped with AC5 input |
| Weight (without rectifiers) | Approximately 42lbs (19kg) – Base system with 1 rectifier shelf |

| ENVIRONMENTAL | |
|---------------|--|
| NEBs | Evaluated by independent NRTL test lab to Telcordia GR63-CORE and GR1089-CORE [Level 3] |
| Safety | CSA C22.2 No. 60950-1-07, 2nd Ed. + A1:2001 (MOD) Certified for Canada and U.S.; UL60950-1 2nd Ed. |
| RoHS | Compliant to RoHS EU Directive 2002/95/EC RoHS 5/6 |
| EMC | European Directive 2004/108/EC; EN55022, Class A; EN55024; FCC, Class A; GR1089-CORE |

| AGENCY CERTIFICATIONS | |
|-----------------------|--|
| UL | CSA C22.2 No 60950-1-07, 2nd Ed. + A1:2001 (MOD) and UL 60950-1 2ndEd |
| EMI/EMC | European Directive 2004/108/EC; EN55022 (CISPR22) Class A; EN55024 (CISPR24) |
| NEBS LEVEL 3 | GR1089-CORE |

Additional Information

Product Documentation

| | |
|-------------|---|
| H5692448 | Ordering Guide A copy of the appropriate installation manuals below ship with each system. |
| CC848815325 | H5692448 Installation Guide |
| CC848815341 | Advanced Features User Guide for the Pulsar Plus Controller, 167-792-183 |

Ordering Information – Infinity B

The Infinity B is a universal bulk power plant that can be configured as a +24V or -48V single voltage power system or as a “dual voltage” power system that supports rectifiers and converters. The primary voltage is supported by +24V or -48V rectifiers and battery reserve, while secondary voltage is supported by dc/dc converters. The primary voltage can be up to 1,600A for +24V power or 1,200A for -48V power; secondary voltage capacity is up to 600A based on input capacity.

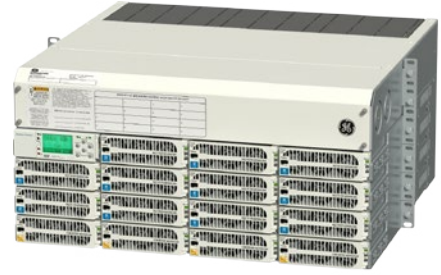





Infinity B systems may be equipped in a 7 ft 23” relay rack; a half rack for mounting on battery stands; or mounting rails for field install applications. The compact size is as little as 6U (10.5”) tall and 20.2” deep. Universal shelves are 1U tall with four slots that accept any Infinity series rectifier or converter.

Key Features

- Infinity Series Rectifiers for +24V and -48V applications
- Dual Voltage power system with ultimate flexibility
- -48V up to 1,200A (65KW) or +24V up to 1,600A (44KW)
- Secondary voltage up to 600A
- High availability wireless telecom applications
- Telecom service providers
- Efficiency approaching 97%

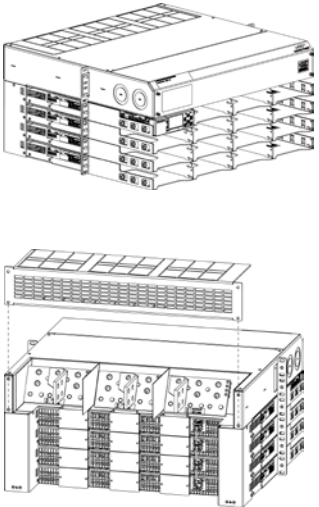
Step 1: Select the Base Power System

Universal Bulk Output

| OUTPUT | ORDERING CODE | MODEL | FRAME | PHOTO |
|---|---------------|--|-------------------------------------|---|
|  24V, 1,600A | 150038896 | Infinity B System with 4 power shelves, each shelf is equipped with 4 universal rectifier/converter slots. Equipped with input / output connection panel that includes bulk output connections for -48V, RTN, and +24V as well as AC input terminal panel. Suitable for frame or cabinet mounting (not included) | No Frame System Width 23” 6RU |  |
|  24V, 1,200A 48V, 160A | | Shipped with: - Two output expansion busbars; expands one connection into 2 back to back connections capable of connecting two 750kCMIL cables. - AC terminal jumpers for connecting 2 rectifiers to a single AC feed. | | |
|  48V, 1,200A | | Note: This system replaces CC109160124. In CC109160124, the NE075 rectifier and NE040 converter output will automatically de-rate to 50A and 30A respectively. | | |
|  48V, 900A 24V, 300A | | | | |

Step 2: Select Mounting Frame

Systems above are configured WITHOUT a mounting frame to facilitate use in cabinets or existing frames. The following frame options are available for the system.

| ORDERING CODE | DESCRIPTION |
|---------------|---|
| CC848828938 | 7ft high, Zone 4 relay rack for mounting 23" wide equipment |
| 850025065 | 6ft high, Zone 4 relay rack for mounting 23" wide equipment |
| 848751132 | 42" high, Zone 4 relay rack for mounting 23" wide equipment |

Step 3: Select Alarm Cables

Alarm Cables

| ORDERING CODE | MODEL | PHOTO |
|---------------|--|--|
| CC848865980 | 15ft Auxiliary input alarm cable for Pulsar Plus Controller |  |
| CC848817651 | 50ft Auxiliary input alarm cable for Pulsar Plus Controller | |
| CC848817668 | 150ft Auxiliary input alarm cable for Pulsar Plus Controller | |
| CC109157442 | 15ft alarm cable for Pulsar Plus Controller | |
| CC848817635 | 50ft alarm cable for Pulsar Plus Controller | |
| CC848817643 | 150ft alarm cable for Pulsar Plus Controller | |





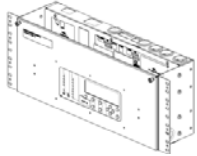





Step 4: Select Controller Options

System Controller







| ORDERING CODE | MODEL | PHOTO |
|---------------|---|---|
| 150042935 | Standard Infinity Pulsar Plus Slot Controller NE843A_S |  |
| CC109132024 | Millennium II Controller in a rack mount configuration (for switch mode rectifiers only) |  |
| CC109169280 | Galaxy Millennium SC Equipped with onboard M2 controller and BSL3_MSC Insulation displacement Alarm Block. (Up to (2) BJC1 or BJC2 circuit cards per system) J2011002 L1 | |

Step 5: Select Rectifiers and Converters

Rectifiers

| OUTPUT | ORDERING CODE | MODEL | PHOTO |
|---|---------------|---|--|
|  100A | CC109160834 | 95 - 145Vac input, 24V, 44A output (max. 50A@24V) 175 - 275Vac input, 24V, 100A output (max. 114A @24V) 145 - 175 linear output increase from 44A to 100A NE100AC24ATEZ |  |
|  100A | 150025075 | 95 - 145Vac input, 24V, 44A output (max. 50A@24V) 175 - 275Vac input, 24V, 100A output (max. 114A @24V) 145 - 175 linear output increase from 44A to 100A 100 - 310 VDC input from Solar resource with full power above 250VDC NE100ECO24ATEZ |  |
|  50A | CC109158878 | 95 - 145Vac input, 48V, 22A output (max. 25A @48V) 175 - 275Vac input, 48V, 50A output (max. 57A @48V) 145 - 175 linear output increase from 22A to 50A NE050AC48ATEZ |  |
|  50A | 150025074 | 95 - 145Vac input, 48V, 22A output (max. 25A @48V) 175 - 275Vac input, 48V, 50A output (max. 57A @48V) 145 - 175 linear output increase from 22A to 50A 100 - 310 VDC input from Solar resource with full power above 250VDC. NE050ECO48ATEZ |  |
|  75A | CC109163473 | 95 - 145Vac input, 48V, 22A output (max. 25A@48V) 175 - 305Vac input, 48V, 75A output (max. 82A@48V) 145 - 175 linear output increase from 22A to 75A NE075AC48ATEZ |  |

Converters

| OUTPUT | ORDERING CODE | MODEL | PHOTO |
|--|---------------|--|---|
|  30A | CC109112471 | 21-30Vdc input, 48V, 30A output NE030DC48A |  |
|  40A | 150023619 | 21-30Vdc input, 48V, 40A output NE04DDC4BAZ |  |
|  75A | CC109142881 | 42-60Vdc input, 24V, 75A output NE075DC24A |  |

Miscellaneous

| ORDERING CODE | MODEL |
|---------------|--|
| CC109170668 | Infinity Rectifier/Converter slot filler (full chassis) |
| CC848798702 | Blank panel for use in empty rectifier / converter positions |

Step 6: Select Remote Peripheral Monitoring Options (Millennium 2 Controller only)

Modules

| ORDERING CODE | DESCRIPTION | # INPUTS | # TEMP | PHOTO |
|---------------|---|----------|--------|---|
| 108469461 | J85501G1L21 RPM Shunt Monitoring (221F) | 6 | 1 |  |
| 108469479 | J85501G1L22 RPM Voltage 0-200VDC (221D) | 6 | 1 | |
| 108469495 | J85501G1L23 RPM Transducers (221J) | 6 | 1 | |
| 108298431 | J85501G1L24 RPM Voltage 0-3VDC (221A) | 6 | 1 | |
| 108298498 | J85501G1L25 RPM Voltage 0-16VDC (221B) | 6 | 1 | |
| 108469503 | J85501G1L26 RPM Voltage 0-70VDC (221C) | 6 | 1 | |
| 108298449 | J85501G1L27 RPM Binary (222A) | 6 | 1 | |
| 108483538 | J85501G1L28 RPM Temperature (223T) | 0 | 7 | |
| 108298456 | J85501G1L9 RPM Control Relay (214A) | 3 | 0 | |

Supporting Materials

| ORDERING CODE | DESCRIPTION | PHOTO |
|---------------|---|--|
| 407377704 | Connecting Cable for RPMs (Order by foot) |  |
| 848535332 | Blue panel for mounting 6 modules above a GPS cabinet | |
| 848412367 | White panel for mounting 6 modules in a 23-inch frame inside GPS bay | |
| 847307410 | 12' Cable to be used with Temperature Probes | |
| 847917879 | 1/2" Diameter Ring Terminal Temperature Probe (Cable Required) | |
| 848528881 | 5/16" Diameter Ring Terminal Temperature Probe (Cable Required) | |
| 405298308 | Termination Resistor (1 per bus) | |
| 405298308 | Ferrite Bead (1 per bus) | |
| 403607955 | Monitor Channel cable KS13385 22AWG stranded pair, R&Bk (order by the foot) | |
| 108984477 | 23" grey panel, 6 RPM mounting panel for Lorain plants | |

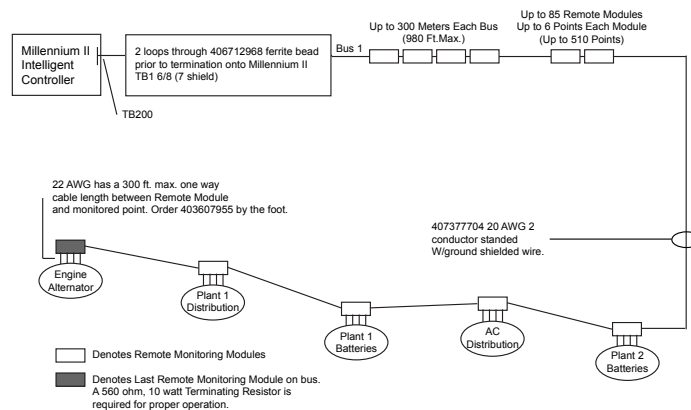





Millennium Remote Monitoring

Step 7: Select Optional AC Monitoring Equipment (Millennium 2 Controller only)

Configured Panels

| ORDERING CODE | DESCRIPTION | PHOTO |
|---------------|--|---|
| CC408646005 | 3P/3W 208/240V Line to Line, 10x12x14 box provides current, voltage, and power |  |
| CC408646046 | 3P/3W 480V Line to Line, 10x12x14 box provides current, voltage, and power | |
| CC408646054 | 3P/4W 208V Line to Neutral, 10x12x14 box provides current, voltage, and power | |

Transducers

| ORDERING CODE | DESCRIPTION | PHOTO |
|---------------|---|---|
| CC408645808 | 1-phase AC Current Transducer (Built-in CT; 150A max current; 350 kcmil max conductor size) |  |
| CC408645816 | 1-phase AC Voltage Transducer 120V |  |
| CC408645824 | 1-phase AC Voltage Transducer 208/240V | |
| CC408644537 | 3-phase AC Voltage Transducer 208/240V Line to Line |  |
| CC408645741 | 3-phase AC Voltage Transducer 208/240V Line to Neutral (120V) | |
| CC408645832 | 3-phase AC Voltage Transducer 480V Line to Line | |
| CC408645840 | 3-phase AC Current Transducer |  |

Current Transformers (Required for Configured Panels and Current Transducers)

| ORDERING CODE | DESCRIPTION | PHOTO |
|---------------|--|---|
| CC408645857 | Current Transformer, 200A primary, 5A secondary, 4 in inside diameter |  |
| 408524862 | Current Transformer, 400A primary, 5A secondary, 4 in inside diameter | |
| CC408645865 | Current Transformer, 600A primary, 5A secondary, 6 in inside diameter | |
| CC408645873 | Current Transformer, 800A primary, 5A secondary, 6 in inside diameter | |
| CC408645881 | Current Transformer, 1000A primary, 5A secondary, 8 in inside diameter | |
| CC408645898 | Current Transformer, 1200A primary, 5A secondary, 8 in inside diameter | |

Step 7: Select Optional AC Monitoring Equipment (Millennium 2 Controller only) (Cont.)

Miscellaneous

| ORDERING CODE | DESCRIPTION |
|---------------|--|
| CC408645907 | Barrier terminal block to extend the CT secondary leads beyond their 12 ft factory length. Use 12 AWG THHN wire in conduit. |
| CC408645915 | Bud Industries Wall Box (12H x 10W x 8D) w/captive screw cover & internal mounting panel. For mounting transducers |

Step 8: Select Distribution Components

Terminal Lugs for Battery and Large Breakers (3/8" bolt on 1" centers)

| ORDERING CODE | STR WIRE GA (CLASS B) | FLEX WIRE GA (CLASS I) | WP-91412 LIST | PHOTO |
|---------------|--------------------------|---------------------------|---------------|--|
| 406338665 | 2 | - | - |  |
| 405348228 | 1/0 | - | - | |
| 405347236 | 2/0 | 1/0 | - | |
| 406021725 | - | 2/0 | - | |
| 405348251 | 4/0 | - | - | |
| 405347923 | - | 4/0 | - | |
| 407890763 | 350 | - | - | |
| 407890748 | - | 350 | - | |
| 406335141 | 750 | - | - | |
| 407890730 | - | 750 | - | |

Step 9: Select Battery Monitoring

| ORDERING CODE | DESCRIPTION | PHOTO | |
|---------------|--|-------|-------------------------------------|
| CC109142980 | QS873A Thermal Probe (A) | | |
| 150026698 | QS873B Ambient Thermal Probe (A) | | |
| CC848817024 | 10 ft wire set | | (B: thermal probe to controller) |
| CC109157434 | 20 ft wire set | | (B: thermal probe to controller) |
| CC848822560 | 1 ft wire set | | (C: thermal probe to thermal probe) |
| 848719803 | 5 ft wire set | | (C: thermal probe to thermal probe) |
| CC848822321 | 10 ft wire set | | (C: thermal probe to thermal probe) |
| 850027334 | 20 ft wire set (C: thermal probe to thermal probe) | | |
| 108958422 | ES771A Battery Voltage Monitor Card | | |
| CC848791517 | 2-1/2 ft wire set | | (D: ES771A to thermal probe) |
| CC848797290 | 6 ft wire set | | (D: ES771A to thermal probe) |
| 848719829 | 10 ft wire set | | (D: ES771A to thermal probe) |
| CC848791500 | 4 ft wire set | | (G: ES771A to ES771A or controller) |
| 848652947 | 10 ft wire set | | (G: ES771A to ES771A or controller) |
| 555052-1 | In-Line Coupler (for extending item G above) | | |

Temperature/Voltage probes are needed for battery monitoring. They are connected to each battery or battery string to provide slope thermal compensation, temperature alarms and voltage imbalance alarms.

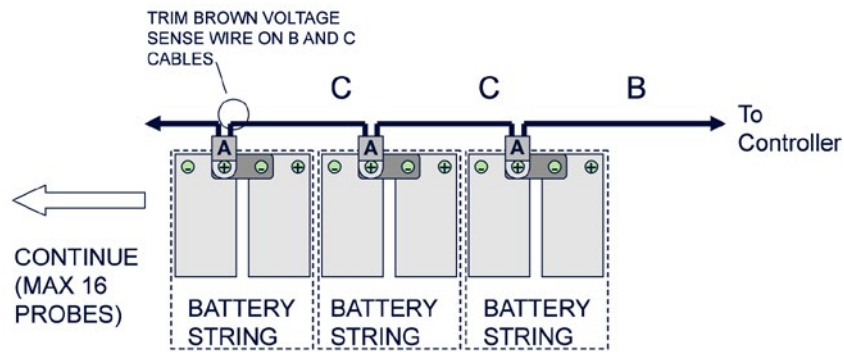

Temperature Measurement

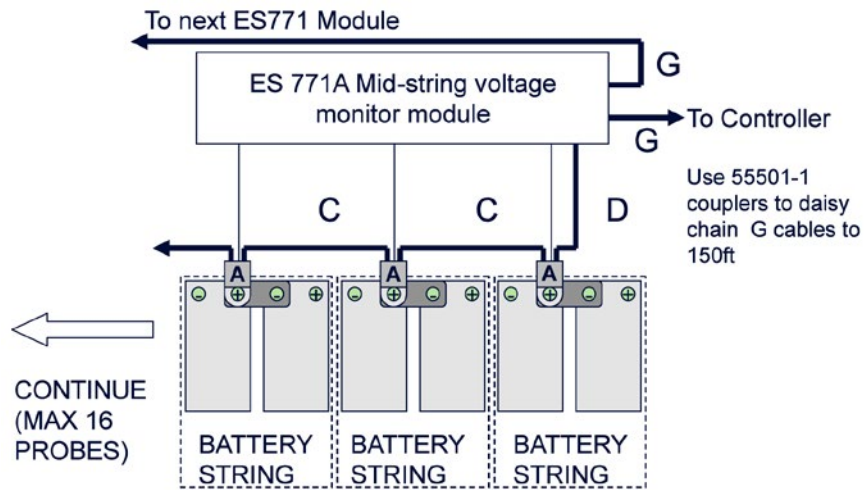

Temperature and Voltage Measurement

Reliability

- Distributed fault tolerance
- Proven field performance
- Controller continuity

Intelligence

- Industry leading controller features
- Ethernet interface for remote access
- Centralized network management

Investment Protection

- Module Compatibility
- Power Shelf Growth
- Secondary Voltage flexibility +24V / -48V
- Flexible Upgrade Options

On Time Delivery

- Standard building blocks
- 4 - 6 week availability
- 24/7 technical support

Management Visibility

Galaxy Manager* software is the centralized visibility and control component of a comprehensive power management system designed to meet engineering, operations and maintenance needs. The Galaxy Manager client-server architecture enables remote access to system controllers across the power network.

- Dashboard display with one-click access to management information database
- Trend analysis
- Scheduled or on demand reports
- Fault, configuration, asset, and performance management

Training

GE offers on-site and classroom training options based on certification curriculum. Technical training can be tailored to individual customer needs. Training enables customers and partners to more effectively manage and support the power infrastructure. We have built our training program on practical learning objectives that are relevant to specific technologies or infrastructure design objectives.

Service & Support

GE field service and support personnel are trusted advisors to our customers – always available to answer questions and help with any project, large or small. Our certified professional services team consists of experts in every aspect of power conversion with the resources and experience to handle large turnkey projects along with custom approaches to complex challenges. Proven systems engineering and installation best practices are designed to safely deliver results that exceed our customers' expectations.

Warranty

GE is committed to providing quality products and solutions. We have developed a comprehensive warranty that protects you and provides a simple way to get your products repaired or replaced as soon as possible.

For full warranty terms and conditions please go to www.gecriticalpower.com.

GE
Critical Power
601 Shiloh Road
Plano, TX 75074
+1 877 546 3243
www.gecriticalpower.com

*Registered trademark of the General Electric Company.
The GE brand, logo, and lumination are trademarks of the General Electric Company. © 2015 General Electric Company. Information provided is subject to change without notice. All values are design or typical values when measured under laboratory conditions.
CPB-NEB, Rev. 06/2015