



# Infinity S-Flex DIN Power System

## 48V DC Power System



### Overview

The Infinity S-FLEX DIN Rail DC power system is a modular power plant that supports -48V operation through the use of a comprehensive range of advanced rectifiers. The Infinity S-Flex Power System can support an output capacity up to 27kW and be equipped with one or two distribution heads.

### Shelf / Bay Options

Infinity S-Flex DIN Rail systems may be equipped in a 7ft 19" or 23" relay rack; a half height rack for mounting on battery stands; indoor or outdoor power cabinets; or mounting rails for field install applications. Each distribution module is 3U (133mm) tall and accommodates up to 26 load DIN breaker positions and up to 8 battery DIN breaker positions. A secondary distribution panel can be added to extend accommodate an additional 30 breaker positions. Universal shelves are 1U tall with three slots that accept any Infinity series rectifier. This allows the available slots to be filled with the mix of power modules desired. The only restriction is whether AC power or solar power is applied to each position. This gives the user the flexibility to provision the system with ECO sourced rectifiers now or in the future.

### Infinity Rectifier Family

The Infinity S-Flex DIN Rail system currently supports -48V rectifiers only. For easy module selection, the rectifiers are color coded to quickly identify voltage, module type and input voltage type (AC or Solar). Please see our other Infinity DC power system products for dual voltage applications.

### Galaxy Pulsar\* Family Controller

The Galaxy Pulsar family controller is used throughout many of the GE DC Power products including GPS, Infinity, CP, CPS and SPS with the only differentiator being the form factor which is scaled to meet the nature of the application. The controller utilizes standard network management protocols allowing for advanced network supervision with secure SNMP communications to deliver extensive monitoring and control features with both local and remote access.

### Advantages

- ECO Priority Source\* ready
- Multi-voltage power systems with ultimate flexibility
- -48V up to 27kW (500A)
- DIN rail distribution with optional critical load bus
- High availability wireless telecom applications
- Telecom service providers
- Efficiency approaching 97%

# Infinity Recifiers

- Compact – 1RU form factor providing high power density (24 W/in<sup>3</sup>)
- Plug and Play – installation of the rectifier in a shelf connected to a compatible system controller initializes all set up parameters automatically. No adjustments are needed.
- Extended service life – parallel operation with automatic load sharing ensures that parallel units are not unduly stressed even when a unit fails or is removed.
- Monitoring / control – the built in microprocessor controls and monitors all critical rectifier functions and communicates with the system controller using the built in Galaxy Protocol serial interface.
- Fail safe performance – hot insertion capabilities allow for converter replacement without system shutdown; soft start and inrush current protection prevent nuisance tripping of upstream breakers.



## Applications

- Telecommunications Networks
- Digital Subscriber Line (DSL)
- Indoor/Outdoor Wireless
- Routers/Switches
- Fiber in the Loop
- Transmission
- Off-Grid/On-Grid Renewable Energy Sites
- Data Networks
- Distributed Antenna Systems

## Key Features

- Extended temperature range
- Redundant fan cooling
- Front panel LED indicators
- 1U height, hi power density
- 220/110V AC input
- Digital load sharing
- Direct solar input (no inverter required)
- Hot pluggable
- RoHS compliant

## Specifications

INPUT	NE050AC48ATEZ / NE050ECO48ATEZ	NE075AC48ATEZ
Voltage Range	95-275Vac	95-305Vac
Input Current	15-12A @100-120Vac 15-12A @ 200-240Vac	15-12A @ 100-120Vac 22-18A @ 200-277Vac
Input Frequency	45 – 66Hz	45 - 66Hz
Power Factor	0.98 @ >50% load	0.98 at>50% load
Efficiency	> 96% (Peak 96.5%)	> 95% (Peak 95.7%)
Total Harmonic Distortion	< 5% @ loads over 50%	<5% @loads over 50%

OUTPUT	2725 WATTS	4085 WATTS
Voltage Adjust Range	42-58Vdc	42-58Vdc
Voltage Nominal	54.5V	54.5V
Regulation (with controller)	±0.5%	±0.5%
Ripple	100mVrms	100mVrms
Output Current		
- High-Line	57A @48V 50A @54.5V	85A @48V 75A @54.5V
- Low-Line	22A @54.5V	22A @54.5V
Heat Dissipation @ max out	158W / 539 BTU/hr	249W / 850 BTU/hr

## Specifications (Cont.)

ENVIRONMENTAL	
Operating Temperature	-40°C to +75°C (-40°F to 167°F) Full capacity up to 55°C; output derates 2%/°C from 55°C to 75°C
Storage Temperature	-40°C to +85°C (-40°F to 185°F)
Humidity	< 95% non-condensing
Altitude	4000M (for altitudes above 2000M, peak operating temperature de-rates 0.656° C /100M; 4000M peak temperature rating is 62° C)

MECHANICAL	
Length (in. /mm)	13.85 / 351.8
Width (in. /mm)	5.23 / 133
Height (in. /mm)	1.63 / 42
Weight (lb / Kg)	5.05 / 2.2

SAFETY AND STANDARDS COMPLIANCE	
NEBs Level 3	Evaluated by independent NRTL test lab to Telcordia GR63, Issue 3 & GR 1089, Issue 5
Safety	CE mark to Low Voltage Directive 2006/95/EC and EMC Directive 2004/108/E (Rectifiers only) UL 60950-1, 2nd Ed. Recognized CSA C22.2 No. 60950-1-03 Certified
RoHS	Compliant to RoHS EU Directive 2002/95/EC; RoHS 6/6 models with Z suffix (RoHS 5/6 all other models)
EMC	European Directive 2004/108/EC; EN55022, Class A; EN55024; FCC, Class A; GR1089-CORE, Issue 5
ESD	EN61000-4-2, Level 4

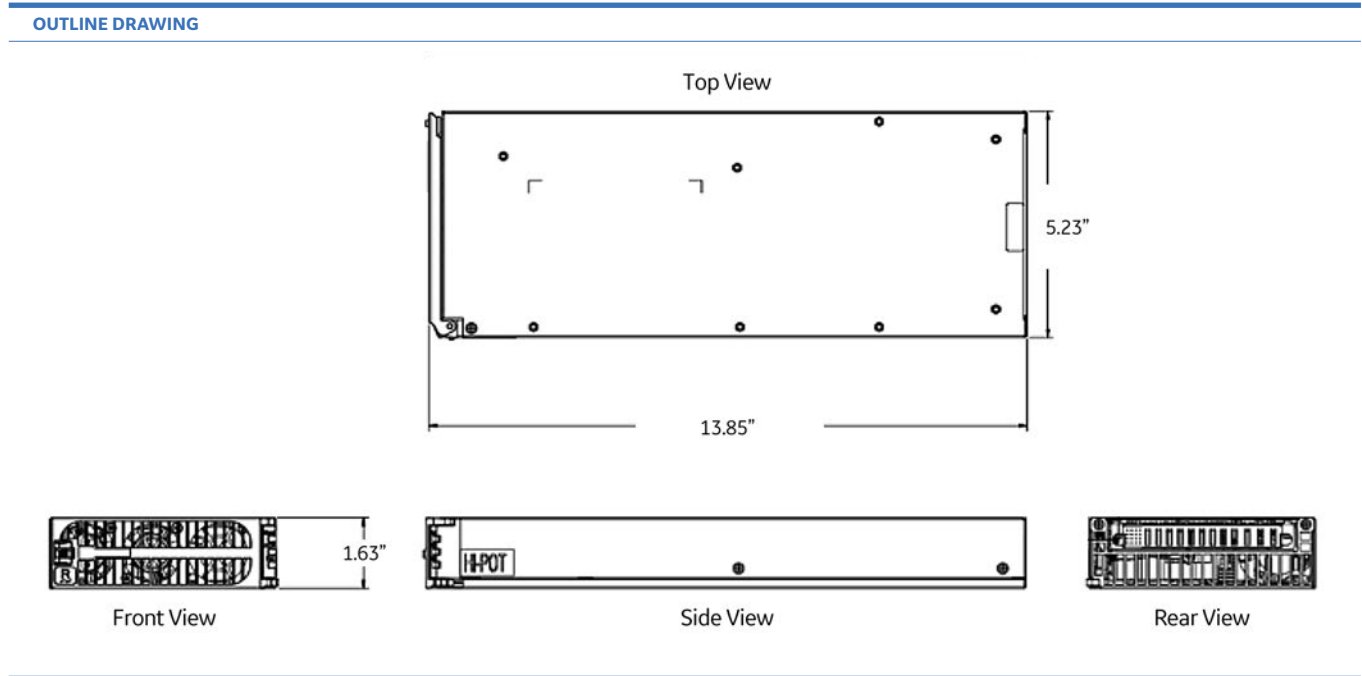

# Pulsar Plus Controller

The Pulsar Plus family of controllers provides system monitoring and control features for Infinity, CP, and other power systems. These controllers monitor and control system components including rectifiers, converters, and distribution modules via a multi-drop RS485 digital communications bus. System status, parameters, settings, and alarm thresholds can be viewed and configured from the controller's front panel display. Assignment and configuration of alarm inputs and output relays can be performed from a laptop computer connected to a local RS-232 or Ethernet port, or by remote access is through a secure network connection to the World Wide Web (internet) or your enterprise network (intranet). An optional modem is also available.



This controller utilizes standard network management protocols allowing for advanced network supervision. The GE Galaxy Manager\* software is the centralized visibility and control component of a comprehensive power management system designed to meet engineering, operations and maintenance needs. The Galaxy Manager client-server architecture enables remote access to system controllers across the power network, featuring ECO Priority advanced monitoring features which provides detailed energy source analysis to help better customize your renewable energy resources.

## Applications

- Telecommunications Networks
- Digital Subscriber Line (DSL)
- Indoor/Outdoor Wireless
- Routers/Switches
- Fiber in the Loop
- Transmission
- Off-Grid/On-Grid Renewable Energy Sites
- Data Networks
- PBX

## Key Features

### Remote Access and Features

- Integrated 10/100Base-T Ethernet Network
  - TCP/IP with IPV6 Capability
  - SNMP V3 for management
  - SMTP for email
  - Telnet for command line interface
  - DHCP for plug-n-play
  - FTPS for rapid backup and upgrades
  - HTTPS for standard web pages and browsers
  - Compatible with Galaxy Manager and other management packages
  - Shielded RJ-45 interface referenced to chassis ground
- Password protected security levels: User, Super-User, Administrator for all access
- Ground-referenced RS232 system port
- ANSI T1.317 command-line interface
- Modem access support
  - Remote via external modem
  - Callback security
- EasyView2, Windows-based GUI software for local terminal or Modem access

- ECO Priority controls and features
  - Advanced generator controls to help minimize fuel consumption for off grid applications
  - ECO Energy Management allowing for non-ECO sources outputs to be minimized while ECO resources are available
  - Source and load trend logging

### Standard System Features

- Monitor and control of more than 40 connected devices
  - Robust RS485 system bus
- Standard and user defined alarms
  - Alarm test
  - Assignable alarm severity: Critical, Major, Minor, Warning, and record-only
  - 10 alarm relays (7 user assigned)
- Rectifier management features
  - Automatic rectifier restart
  - Active Rectifier Management ARM (energy efficiency)
  - Remote rectifier (on/off)
  - Reserve Operation
  - Automatic rectifier sequence control
  - N + X redundancy check

- Multiple Low Voltage Load and Low Voltage Battery Disconnect thresholds
- Configuration, statistics, and history
  - All stored in non-volatile memory
  - Remote/local backup and restore of configuration data
- Industry standard defaults
  - Customer specific configurations available
- Remote/local software upgrade
- Basic, busy hour, and trend statistics
- Detailed event history
- User defined events and derived channels

### Standard Battery Management Features

- Float/boost mode control
  - Manual boost
  - Manual timed boost locally, T1.317, and remotely initiated
  - Auto boost terminated by time or current
- Battery discharge testing
  - Manual (local/remote)
  - Periodic
  - Plant Battery Test (PBT) input driven

### Key Features (Cont.)

- Configurable threshold or 20% algorithm
- Graphical discharge data
- Rectifiers on-line during test
- Slope thermal compensation
  - High temperature
  - Low temperature
  - Step temperature
  - STC Enable/Disable, low temperature Enable/Disable
  - Configurable mV/°C slopes
- State of charge indication
- High temperature disconnect setting
- Reserve-time prediction
- Recharge current limit
- Emergency Power-Off input

### Integrated Monitoring Inputs/Outputs

- System plant voltage (accuracy  $\pm 0.5\%$ , resolution 0.01V)
- One system shunt (accuracy  $\pm 0.5\%$  full scale, resolution 1A)
  - Battery or load
  - Mounted in the return side of DC bus
- Up to 15 binary inputs
  - 6 inputs close/open to battery
  - 9 input close/open to return
  - User assignable
- Up to 7 Form-C output alarms (60VDC @ .5A)
  - User assignable
- 1-Wire™ bus devices
  - Up to 16 temperature probes (QS873)
  - Up to 6 mid-string monitors (ES771)

### Galaxy Manager Compatible

- Centralized web server and database with multiple user access to live or managed data with drill down to problem details
- Monitor and control of more than 40 connected devices
- Management information from polling or alarms received from alarm traps from multiple sites are available on one screen via the inter/intranet
- Trend user selected data over time
- Automatic or manual report generation
- Standard engineering tools like reserve time calculators and cable voltage drop analyzer

## Specifications

GENERAL	
Operating Voltage	$\pm 24$ Vdc, $\pm 48$ Vdc (Range: $\pm 18$ to $\pm 60$ Vdc)
Input Power	Less than 7W
Operating Temperature Range	-40°C to +75°C (-40°F to 167°F)
Operating Relative Humidity	0 - 95% (non-condensing)
Storage Temperature Range	-40°C to +85°C (-40°F to 185°F)
Physical Specifications	Sizes vary by packaging option
Display	8-line by 40-character with alarm context sensitive backlit LCD

The diagram illustrates the LCD display's color-coded states for different battery conditions. Each state shows a voltage of -54.48V and a current of 100A. The states are: Green (No Alarms, Menu), Amber (Float, Menu), Yellow (CHARGE, Menu), and Red (CHARGE, Menu).

SAFETY AND STANDARDS COMPLIANCE	
NEBs	Evaluated by independent NRTL test lab to Telcordia GR63, Issue 3 and GR1089-CORE, Issue 5
Safety	CSA C22.2 No. 60950-1-03 Certified for Canada and U.S.; UL60950-1 1st Ed.
RoHS	Compliant to RoHS EU Directive 2002/95/EC RoHS 5/6
EMC	European Directive 2004/108/EC; EN55022, Class A, EN55024; FCC, Class A; GR1089-CORE, Issue 5

AGENCY CERTIFICATIONS	
NEBs Level 3	Evaluated by independent NRTL test lab to Telcordia GR63, Issue 3 and GR1089-CORE, Issue 5
EMC	European Directive 2004/108/EC; EN55022, (CISPR22) Class A, EN55024 (CISPR24)
Safety	Underwriters Laboratories (UL) Listed per Subject Letter 1801: Power Distribution Center for (CSA 22.2 950): Safety of Information Technology Equipment

# Pulsar Edge Controller

The SPS Pulsar Edge controller delivers large system intelligence in a small system form factor. This family of controllers functions as network interface cards (NIC) and as a full-featured battery plant controller. Its thin modular plug-in form factor minimizes shelf space consumption allowing maximum power module and distribution capabilities.



The controller is utilized in bulk power applications in data centers and enterprise applications. Ethernet connectivity with SNMP V3 facilitates secure remote network management. Access through its front-accessible RS232 or USB port and aided by the EasyView2 graphical interface enables full user interface locally. Optional 1U display version allows convenient access to all controller functions without requiring external cable connections. The display also features alarm context sensitive backlighting for at-a-glance system status.

As a battery plant controller, it provides a complete set of features to monitor and control rectifiers, batteries, and distribution. A flexible set of configurable inputs allow the Pulsar Edge controller to monitor a wide variety of system equipment and incorporate appropriate state information enabling a centralized point of management. The controller utilizes standard network management protocols allowing for advanced network supervision. GE Galaxy Manager\* software is the centralized visibility and control component of a comprehensive power management system designed to meet engineering, operations and maintenance needs. The Galaxy Manager client-server architecture enables remote access to system controllers across the power network.

## Applications

- Telecommunications Networks
- Digital Subscriber Line (DSL)
- Indoor/Outdoor Wireless
- Routers/Switches
- Fiber in the Loop
- Transmission
- Data Networks
- PBX

## Key Features

### Remote Access and Features

- Integrated 10/100Base-T Ethernet Network
  - TCP/IP with IPV6 Support
  - SNMP V3 for management
  - SMTP for email
  - Telnet for command line interface
  - DHCP for plug-n-play
  - FTPS for rapid backup and upgrades
  - HTTPS for standard web pages and browsers
  - Compatible with Galaxy Manager and other management packages
  - Shielded RJ-45 interface referenced to chassis ground
- Password protected security levels: User, Super-User, Administrator for all access
- Ground-referenced RS232 system port
- ANSI T1.317 command-line interface
- Modem access support
  - Remote via external modem
  - Callback security

- EasyView2, Windows-based GUI software for local terminal or Modem access
- Optional 1U display with alarm indicating backlight feature

### Standard System Features

- Monitor and control of more than 40 connected devices
  - Maximum of 32 rectifiers
  - Maximum of 6 distribution control cards
  - Robust RS485 system bus
- Standard and user defined alarms
  - Alarm test
  - Assignable alarm severity: Critical, Major, Minor, Warning, and record-only
- Rectifier management features
  - Automatic rectifier restart
  - Adaptive Rectifier Management (energy efficiency)
  - Remote rectifier (on/off)
  - Reserve Operation

- Automatic rectifier sequence control
- N + X redundancy check
- Multiple Low Voltage Load and Low Voltage Battery Disconnect thresholds (4)
- Configuration, statistics, and history
  - All stored in non-volatile memory
  - Remote/local backup and restore of configuration data
- Industry standard defaults
  - Customer specific configurations available
- Remote/ local software upgrade
- Basic, busy hour, and trend statistics
- Detailed event history
- User defined events and derived channels

## Key Features (Cont.)

### Standard Battery Management Features

- Float/boost mode control
  - Manual boost
  - Manual timed boost locally, T1.317, and remotely initiated
  - Auto boost terminated by time or current
- Battery discharge testing
  - Manual (local/remote)

- Periodic
- Plant Battery Test (PBT) input driven
- Configurable threshold or 20% algorithm
- Graphical discharge data
- Rectifiers on-line during test
- Slope thermal compensation
  - High temperature
  - Low temperature
  - Step temperature

- STC Enable/Disable, low temperature Enable/Disable
- Configurable mV/°C slopes
- State of charge indication
- High temperature disconnect setting
- Reserve-time prediction
- Recharge current limit
- Emergency Power-Off input

### Integrated Monitoring Inputs/Outputs

- System plant voltage (accuracy  $\pm 0.5\%$ , resolution 0.01V)
- One system shunt (accuracy  $\pm 1\%$  full scale, resolution 1A)
  - Battery or load
  - Mounted in the return side of DC bus
- Up to 15 binary inputs
  - 6 inputs close/open to battery
  - 9 input close/open to return (number is dependent upon number of output alarms)
  - User assignable
- Up to 6 user assignable Form-C output alarms (50VDC @.3A)
- 1-Wire™ bus devices
  - Up to 16 temperature probes (QS873)
  - Up to 6 mid-string monitors (ES771)

### Galaxy Manager Compatible

- Centralized web server and database with multiple user access to live or managed data with drill down to problem details
- Monitor and control of more than 40 connected devices
- Management information from polling or alarms received from alarm traps from multiple sites are available on one screen via the inter/intranet
- Trend user selected data over time
- Automatic or manual report generation
- Standard engineering tools like reserve time calculators and cable voltage drop analyzer

## Specifications

GENERAL	
Operating Voltage	$\pm 24$ Vdc, $\pm 48$ Vdc (Range: $\pm 18$ to $\pm 60$ Vdc)
Input Power	Less than 7W
Operating Temperature Range	-40°C to +70°C (-40°F to 167°F)
Operating Relative Humidity	0 - 95% (non-condensing)
Storage Temperature Range	-40°C to +85°C (-40°F to 185°F)
Physical Specifications	1.75 in. H, 0.75 in. W, 8.00 in. D; 0.5lb
Display	8-line by 40-character backlit LCD
EMC	FCC/EN55022 Class A, CISPR22 Level A

AGENCY CERTIFICATIONS	
Electrostatic Discharge	EN 61000-4-2 level 4
Radiated Emissions	FCC, Class A; EN 55022, Class A
Safety	UL listed Component as Part of CPL or SPS Power System

# Infinity S-Flex System

Infinity S-Flex can be configured as a -48V voltage power system. Infinity S-Flex is configurable from 150A with a single rectifier shelf and single distribution (22 Load / 8 Battery) up to 500A with four rectifier shelves and two distributions (52 Load / 8 Battery). The system includes optional low voltage battery disconnect, low voltage load disconnect, and low voltage load disconnect with critical load bus for load shedding to maintain critical loads.



## Applications

- Wireless Telecom Networks
- Central Office
- Indoor/Outdoor Wireless
- Remote Radio Sites
- Data Networks
- Off-Grid/On-Grid Renewable Energy Sites

## Key Features

- Redundant fan cooling
- Front panel LED indicators
- 1U height, hi power density
- 277/220/110 V AC input
- Digital load sharing
- Hot pluggable
- RoHS 6 compliant
- ECO Priority ready

## Specifications

INPUT	MIN	TYP	MAX
Voltage Range			
- High-Line	175Vac	220Vac	305Vac
- Low-Line	85Vac	110Vac	140Vac
Frequency	45Hz	60Hz	66Hz
Power Factor	98%	99.5%	
Total Harmonic Distortion	5%		

PRIMARY OUTPUT	
Nominal Voltage	-48Vdc
Output (Power/Current)	500A / 27kW
Vo Setpoint (Factory)	-54.5Vdc±1%
Vo Range	-42Vdc to -58Vdc
Regulation	±0.5%

MECHANICAL	
Height (in. /mm)	17.5 / 445 (Full system with 4 power shelves) 7 / 178 (Basic system with single distribution and one rectifier shelf)
Width (in. /mm)	19 / 484 (System Only) 23 / 584 (Mounted in Frame)
Depth (in. /mm)	16.75 / 425 (No AC Cover) 18.75 / 476 (With AC Cover)
Weight (lb / Kg)	78 / 35 (Base System with 4 power shelves) 190 / 86 (Base System in zone 4 7ft frame)



## Specifications (Cont.)

<b>ENVIRONMENTAL</b>	
Operating Temperature	-40°C to +75°C (-40°F to 167 °F)
Storage Temperature	-40°C to +85°C (-40°F to 185 °F)
Relative Humidity	95% max, non-condensing
Altitude	4000M (for altitudes above 2000M, peak operating temperature de-rates 0.656° C /100M; 4000M peak temperature rating is 62° C)

<b>SAFETY AND STANDARDS COMPLIANCE</b>	
NEBs	Evaluated by independent NRTL test lab to Telcordia GR63, Issue 3 and GR1089-CORE, Issue 5
Safety	CSA C22.2 No. 60950-1-03 Certified for Canada and U.S.; UL60950-1 1st Ed.
RoHS	Compliant to RoHS EU Directive 2002/95/EC RoHS 5/6
EMC	European Directive 2004/108/EC; EN55022, Class A; EN55024; FCC, Class A; GR1089-CORE, Issue 5

<b>AGENCY CERTIFICATIONS</b>	
CSA	CSA C22.2 No 60950-1-03 and UL 60950-1 1st Ed
EMI/EMC	European Directive 2004/108/EC; EN55022 (CISPR22) Class A; EN55024 (CISPR24)
NEBS LEVEL 3	GR1089-CORE, Issue 5

# Ordering Information – Infinity S-Flex Power System

## Ordering Guide

Infinity S-Flex may be configured as a -48V voltage power system. Infinity S-Flex is configurable from 150A with a single rectifier shelf and single distribution (22 Load / 8 Battery) up to 500A with four rectifier shelves and two distributions (52 Load / 8 Battery). The system includes optional low voltage battery disconnect, low voltage load disconnect, and low voltage load disconnect with critical load bus for load shedding to maintain critical loads.

Infinity S-Flex systems may be equipped in a 2133mm (7ft) framework, a half-height 1067mm (42") frame for mounting on battery stands, or supplied frameless for field install applications.

## Features

- Infinity Series Rectifiers for -48V applications
- Configurable DIN breaker panels with individual breaker alarming and separate battery breaker bus
- The initial distribution shelf is rated for 300A with an optional 200A distribution panel with 30, 13mm DIN breaker positions
- Optional programmable Low Voltage Battery and Load Disconnects
- Optional programmable Low Voltage Load Disconnect with critical load bus (Critical load bus only disconnects on LVBD)
- Temperature hardened harsh environments. (-40°C to +75°C)
- Compact size: Base System with 1 power shelves occupies 4 RU
- (7 in / 178mm) of 2133mm (19") wide rack space (425 – 502 mm / 16.75 – 19.75" depth)
- Frame options – Factory installed in 7ft or 42" tall, 19" wide frame or field installed in user supplied frame
- Battery connections, LVBD and LVLD options
- Plug-N-Play Pulsar Plus or Pulsar Edge controller with Web based interface for local and remote secure (LAN) access
- Distribution options include 5A-200A DIN style circuit breakers with alarm connections











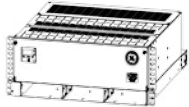

## Additional Information

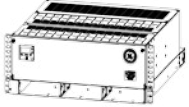
### Product Documentation

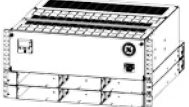
NES-Flex-Systems	Infinity S-Flex Configuration drawing
CC848836981	User Guide for the Galaxy Pulsar Edge System Controller
CC848815341	Advanced Features User Guide for the Pulsar Plus Controller, 167-792-183
850035894	Pulsar Edge Quick Start Guide
850037453	J2012001 3U DIN Distribution Shelf Quick Start Guide
850039275	Infinity J5694803 L213 - L218 19" Universal Power Shelf Quick Start Guide

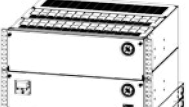

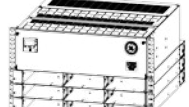

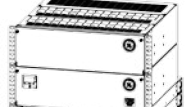

# Step 1: Select System

## -48V Standard Load System

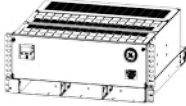
OUTPUT	DESCRIPTION	AC INPUT	LVD	FRAME	ORDERING CODE	MODEL	PHOTO
 <b>225A</b>	225A Infinity S Power system equipped with 3 universal positions, 20 distribution and 4 Two-Pole Battery positions. System is equipped with a Pulsar Edge controller	Ind Term Block	None		150042312	NES48-19-4U-AC5-PS3-DIN20B250	
		Ind Term Block	LVBD		150042314	NES48-19-4U-AC5-PS3-DIN20B250-LVBD	
 <b>225A</b>	225A Infinity S Power system equipped with 3 universal positions, 24 distribution and Bulk Battery output. System is equipped with a Pulsar Edge controller	Ind Term Block	LVBD		150043472	NES48-19-4U-AC4-PS3-DIN24B250-LVBD	
 <b>250A</b>	250A Infinity S Power system equipped with 6 universal positions, 20 distribution and 4 Two-Pole Battery positions. System is equipped with a Pulsar Edge controller	Ind Term Block	None		150042313	NES48-19-5U-AC5-PS6-DIN20B250	
 <b>250A</b>	250A Infinity S Power system equipped with 6 universal positions, 50 distribution positions and 4 Two-Pole Battery positions. System is equipped with a Pulsar Edge controller	Ind Term Block	None		150042317	NES48-19-8U-AC5-PS6-DIN50B250	
		Ind Term Block	LVBD		150042318	NES48-19-8U-AC5-PS6-DIN50B250-LVBD	
 <b>500A</b>	500A Infinity S Power system equipped with 9 universal positions, 20 distribution positions and 4 Two-Pole Battery positions. System is equipped with a Pulsar Edge controller	Ind Term Block	None		150042306	NES48-19-6U-AC5-PS9-DIN20B500	
		Ind Term Block	LVBD		150042307	NES48-19-6U-AC5-PS9-DIN20B500-LVBD	
 <b>500A</b>	500A Infinity S Power system equipped with 9 universal positions, 50 distribution positions and 4 Two-Pole Battery positions. System is equipped with a Pulsar Edge controller	Ind Term Block	None		150042309	NES48-19-9U-AC5-PS9-DIN50B500	
		Ind Term Block	LVBD		150042310	NES48-19-9U-AC5-PS9-DIN50B500-LVBD	

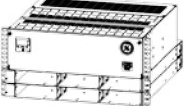
## Step 1: Select System (Cont.)

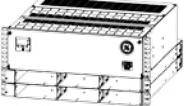
### -48V Critical Load Systems with Non-Critical load Disc.

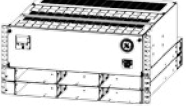
OUTPUT	DESCRIPTION	AC INPUT	LVD	FRAME	ORDERING CODE	MODEL	PHOTO
 225A	225A Infinity S Power system equipped with 3 universal positions, 8 Critical Loads, 12 Non-Critical and 4 Two-Pole Battery positions. System is equipped with a Pulsar Edge controller.	Ind Term Block	250A LVBD 250A Critical Load LVLD		150042315	NES48-19-4U-AC5-PS3-DIN20B250-LVBD-LVLD	
 250A	250A Infinity S Power system equipped with 6 universal positions, 8 Critical Loads, 12 Non-Critical and 4 Two-Pole Battery positions. System is equipped with a Pulsar Edge controller.	Ind Term Block	A LVBD 250A Critical Load LVLD		150042316	NES48-19-5U-AC5-PS6-DIN20B250-LVBD-LVLD	
 500A	320A Infinity S Power system equipped with 6 universal positions, 8 Critical Loads, 12 Non-Critical and 4 Two-Pole Battery positions. System is equipped with a Pulsar Edge controller.	Ind Term Block	500A LVBD 250A Critical Load LVLD		150042308	NES48-19-6U-AC5-PS9-DIN20B500-LVBD-LVLD	
 450A	320A Infinity S Power system equipped with 6 universal positions, 8 Critical Loads, 12 Non-Critical and 4 Two-Pole Battery positions. System is equipped with a Pulsar Plus controller. ECO Priority Ready	Ind Term Block	500A LVBD 250A Critical Load LVLD		150043208	NES48-19-5U-AC5-PS6-DIN20B500P-LVBD-LVLD	

### Supplemental Rectifier Shelf Kits - Used for Installing Additional Rectifier Shelves to an Infinity S System in the Field







ORDERING CODE	DESCRIPTION	
150041585	NES AC5 19in Single Voltage Supplemental Shelf Kit	Each kit includes: Rectifier shelf with mounting hardware, busbar interconnects with hardware and inter-shelf communication cable
150041586	NES AC6 19in Single Voltage Supplemental Shelf Kit	

Note: Adding these shelves does not increase the overall rating of the distribution.

### Supplemental Rectifier Options

ORDERING CODE	DESCRIPTION
CC848852186	19" Zone 4 Relay rack; Suitable to support 1,800Lbs of equipment and batteries
CC848850033	19" Battery Tray (17" Depth) Typically Batteries include: EnerSys (SBS C11), NorthStar (NSB90FT, NSB100FT) Two IR150 Batteries, 2 Strings IR40s (23" wide)
CC848849950	19" Battery Tray (22" Depth) Typically Batteries include: East Penn (12A100FT), EnerSys (12V125F), Gnb(M12V125F)

## Step 2: Select Rectifiers

OUTPUT	ORDERING CODE	MODEL	PHOTO
 <b>75A</b>	CC109163473	95 - 145Vac input , 48V, 22A output (max. 25A@48V) 175 - 275Vac input , 48V, 75A output (max. 85A@48V) 145 - 175 linear output increase from 22A to 75A  NE075AC48ATEZ	
 <b>50A</b>	CC109158878	95 - 145Vac input , 48V, 22A output (max. 25A @48V) 175 - 275Vac input , 48V, 50A output (max. 57A @48V) 145 - 175 linear output increase from 22A to 50A  NE050AC48ATEZ	
 <b>50A</b>	150025074	95 - 145Vac input , 48V, 22A output (max. 25A @48V) 175 - 275Vac input , 48V, 50A output (max. 57A @48V) 145 - 175 linear output increase from 22A to 50A 100 - 310 VDC input from Solar resource with full power above 250VDC  NE050AC48ATEZ	

## Step 3: Select Alarm Cables

### Alarm Cables

ORDERING CODE	MODEL	PHOTO
CC848865980	15ft Auxiliary input alarm cable for Pulsar Plus Controller	
CC848817651	50ft Auxiliary input alarm cable for Pulsar Plus Controller	
CC848817668	150ft Auxiliary input alarm cable for Pulsar Plus Controller	
CC109157442	15ft alarm cable for Pulsar Plus Controller	
CC848817635	50ft alarm cable for Pulsar Plus Controller	
CC848817643	150ft alarm cable for Pulsar Plus Controller	

## Step 4: Select Distribution Components

### DIN Style Load Circuit Breakers

ORDERING CODE	AMPERAGE	CB POSITIONS (POLES)	MIN WIRE GAUGE	PHOTO
450029223	5	1	10	
450029222	10	1	10	
450029220	15	1	10	
450029219	20	1	10	
450029218	25	1	10	
450029217	30	1	10	
450029214	35	1	8	
CC408654288	40	1	8	
450029213	50	1	6	
450028218	63	1	6	
450031081	100	2	2	
450031083	150	3	1/0	
450031084	200	4	2/0	

### DIN Battery Breakers

ORDERING CODE	CURRENT RATING	POLES
150040992	63A	1
150040991	100A	2
150040993	150A	3
150040994	200A	4

# Step 5: Select Battery Monitoring

ORDERING CODE	DESCRIPTION	PHOTO
CC109142980	QS873A Thermal Probe (A)	
150026698	QS873B Ambient Thermal Probe (A)	
CC848817024	10 ft wire set (B: thermal probe to controller)	
CC109157434	20 ft wire set (B: thermal probe to controller)	
CC848822560	1 ft wire set (C: thermal probe to thermal probe)	
848719803	5 ft wire set (C: thermal probe to thermal probe)	
CC848822321	10 ft wire set (C: thermal probe to thermal probe)	
850027334	20 ft wire set (C: thermal probe to thermal probe)	
108958422	ES771A Battery Voltage Monitor Card	
CC848791517	2-1/2 ft wire set (D: ES771A to thermal probe)	
CC848797290	6 ft wire set (D: ES771A to thermal probe)	
848719829	10 ft wire set (D: ES771A to thermal probe)	
CC848791500	4 ft wire set (G: ES771A to ES771A or controller)	
848652947	10 ft wire set (G: ES771A to ES771A or controller)	
555052-1	In-Line Coupler (for extending item G above)	

Temperature/Voltage probes are needed for battery monitoring. They are connected to each battery or battery string to provide slope thermal compensation, temperature alarms and voltage imbalance alarms.

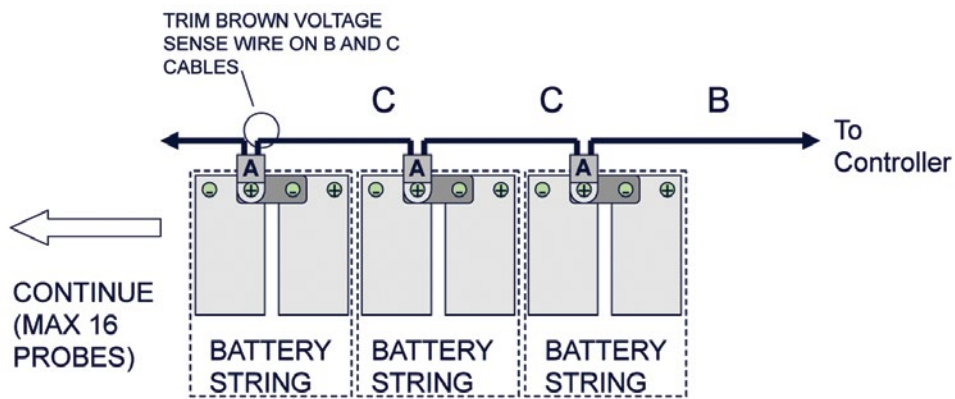

Temperature Measurement

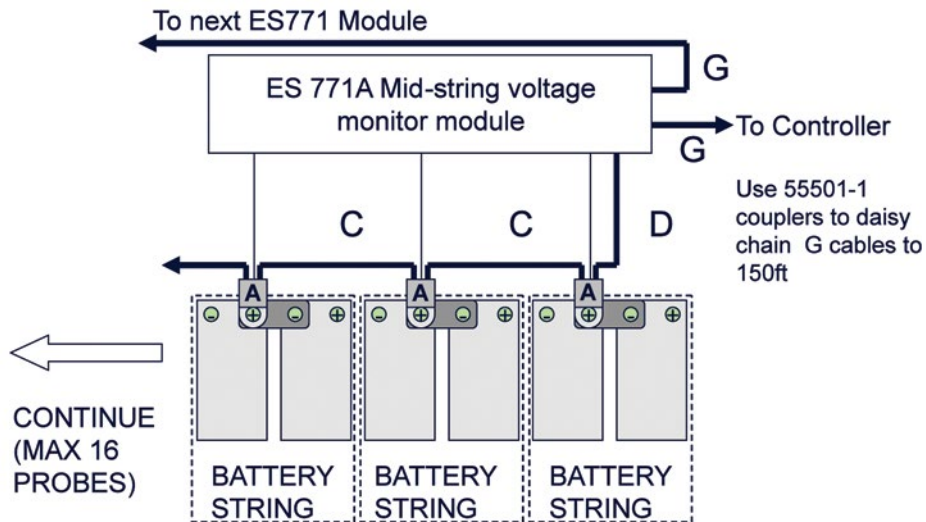

Temperature and Voltage Measurement

## Reliability

- Distributed fault tolerance
- Proven field performance
- Controller continuity

## Intelligence

- Industry leading controller features
- Ethernet interface for remote access
- Centralized network management

## Investment Protection

- Module Compatibility
- Power Shelf Growth
- Renewable Energy Ready
- Flexible Upgrade Options

## On Time Delivery

- Standard building blocks
- 4 - 6 week availability
- 24/7 technical support

## Management Visibility

Galaxy Manager\* software is the centralized visibility and control component of a comprehensive power management system designed to meet engineering, operations and maintenance needs. The Galaxy Manager client-server architecture enables remote access to system controllers across the power network.

- Dashboard display with one-click access to management information database
- Trend analysis
- Scheduled or on demand reports
- Fault, configuration, asset, and performance management

## Training

GE offers on-site and classroom training options based on certification curriculum. Technical training can be tailored to individual customer needs. Training enables customers and partners to more effectively manage and support the power infrastructure. We have built our training program on practical learning objectives that are relevant to specific technologies or infrastructure design objectives.

## Service & Support

GE field service and support personnel are trusted advisors to our customers – always available to answer questions and help with any project, large or small. Our certified professional services team consists of experts in every aspect of power conversion with the resources and experience to handle large turnkey projects along with custom approaches to complex challenges. Proven systems engineering and installation best practices are designed to safely deliver results that exceed our customers' expectations.

## Warranty

GE is committed to providing quality products and solutions. We have developed a comprehensive warranty that protects you and provides a simple way to get your products repaired or replaced as soon as possible.

For full warranty terms and conditions please go to [www.gecriticalpower.com](http://www.gecriticalpower.com).