

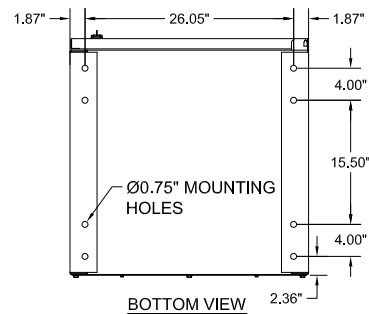

**NOTES:**

- EMPTY CABINET WEIGHT: 425 LBS
- 1. NEMA 1 ENCLOSED BATTERY CABINET.
- 2. FACTORY ASSEMBLED CABINETS ARE LISTED TO UL 1778.
- 3. HEAVY GAUGE WELDED STEEL CONSTRUCTION.
- 4. FINISH IS BLACK DURABLE CHIP & CORROSION RESISTANT POWDER COAT.
- 5. A MINIMUM REAR CLEARANCE OF 2" IS RECOMMENDED FOR OPTIMAL COOLING OF THE EQUIPMENT.
- 6. FOR EASE OF CONDUIT INSTALLATION, (1) 12.50" X 7.50" & (1) 6.25" X 5.125" CONDUIT PLATE IS PROVIDED TO REPLACE A KNOCKOUT IN THE CABINET.
- 7. BATTERIES CAN BE ACCESSED FROM THE FRONT AND REAR.
- 8. CABINET CAN BE MOVED WITH PALLET JACK OR FORK LIFT AT PALLET JACK ACCESS POINTS LOCATED AT FRONT OR REAR OF CABINET. FROM THE SIDES, THE CABINET CAN BE MOVED WITH ROL-A-LIFT TYPE EQUIPMENT MOVER. THE CABINET IS ONLY TO BE LIFTED FROM THE BOTTOM.
- 9. CENTER OF GRAVITY IS FIGURED WITH 200 WATT BATTERIES IN A 480V CONFIGURATION.
- 10. THE BC41S BATTERY CABINET (OPTIONAL CONFIGURATION) HAS BEEN CERTIFIED TO MEET THE 2015 EDITION OF THE INTERNATIONAL BUILDING CODE (IBC) AND THE 2016 EDITION OF THE CALIFORNIA BUILDING CODE (CBC) TO MEET DESIGN CATEGORY F, SS = 2.0 AND IMPORTANCE FACTOR 1.5.

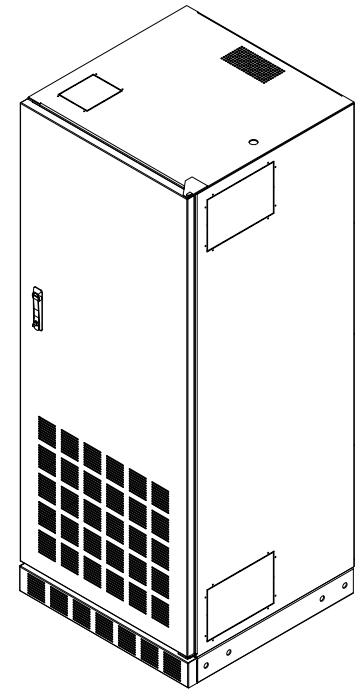
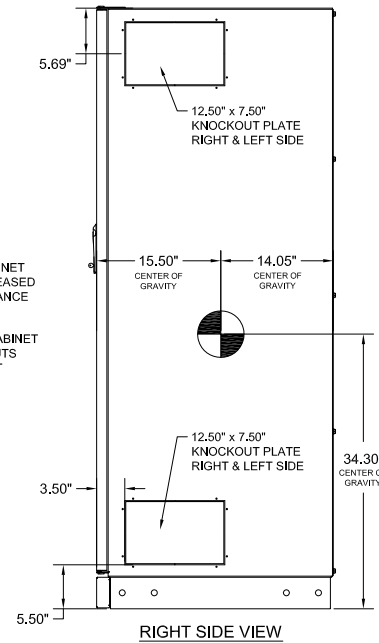
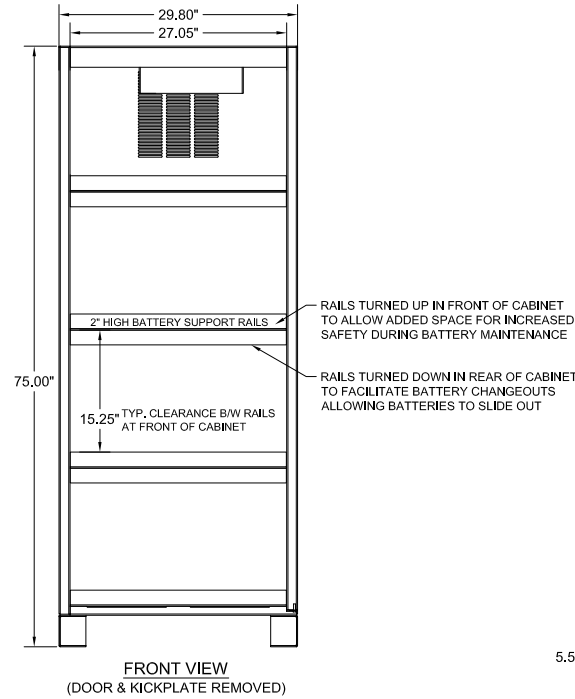
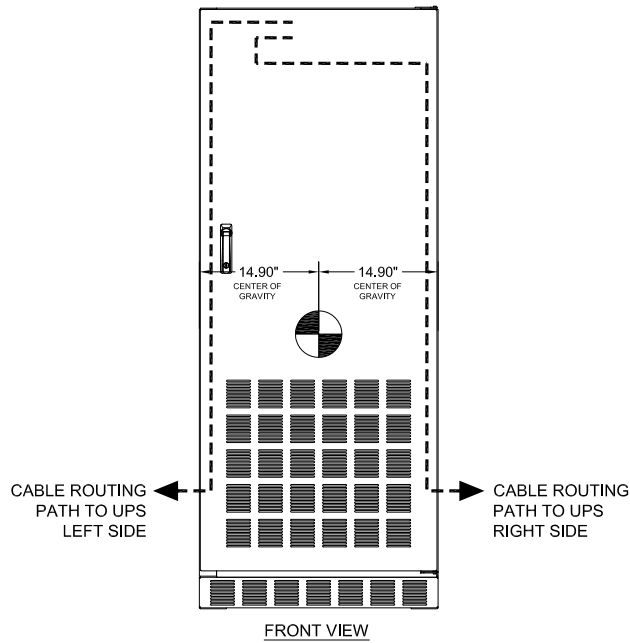

<b>BC41 BATTERY CABINET</b>			
FOR USE WITH GE TLE SERIES 40-80 KVA UPS			
<b>MECHANICAL DRAWING</b>			
THE INFORMATION CONTAINED IN THIS DRAWING IS THE SOLE PROPERTY OF C&C POWER, INC. ANY REPRODUCTION WITHOUT THE WRITTEN CONSENT OF C&C POWER, INC IS PROHIBITED.			
DIMENSIONS ARE IN INCHES	INITIALS	DATE	
TOLERANCES:	DRAWN JRL	11/15/2017	
DECIMALS: .XX ±.13	CHECKED CH	11/15/2017	
ANGLES: .XXX ±.082			
SCALE: NTS	SIZE: A	REV: 1	SHEET 1 OF 2



Manufactured by C&C Power for GE

© 2017 C&C POWER, INC. ALL RIGHTS RESERVED

DRAWING # 91441-SDF01-TLE2 REV.1

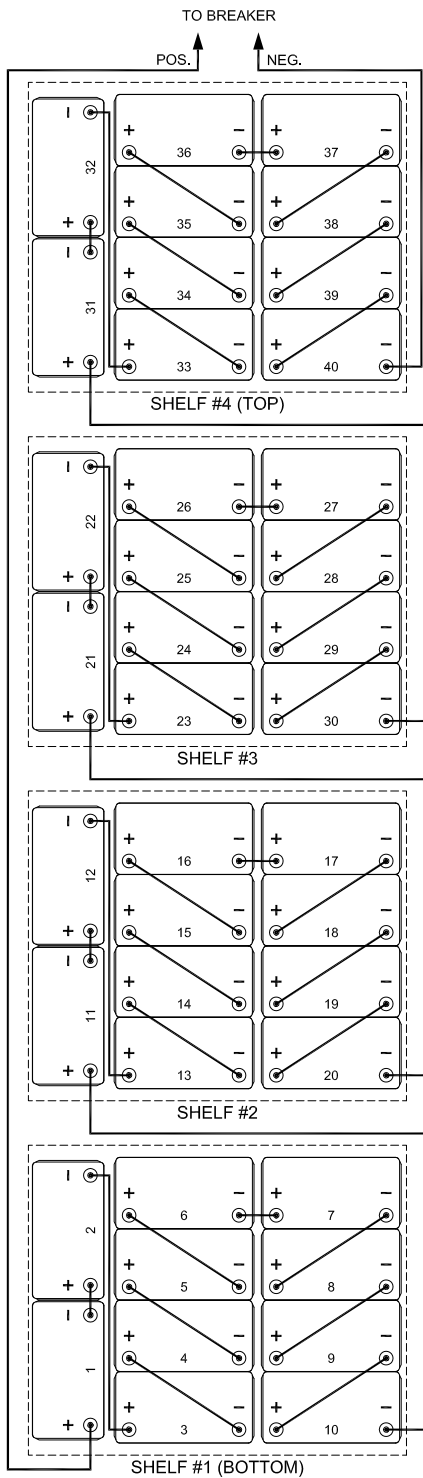

**480 VDC TYPICAL WIRING**

**BREAKER WIRING**

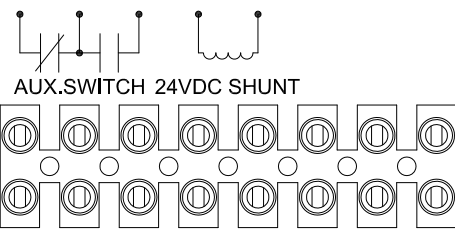
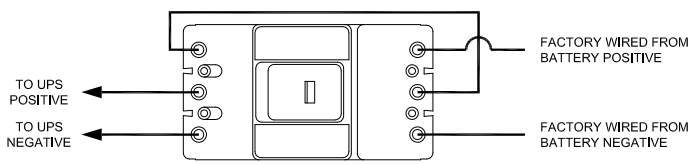

NOTE: CONTACTS SHOWN WITH THE BREAKER IN THE CLOSED POSITION

**40KVA - 80KVA TLE SERIES  
BREAKER ACCESSORIES**

**NOTES:**

1. ALL INTERNAL WIRING IS UL LISTED, MTW, STYLE, 105C, EXTRA FLEXIBLE CABLE.
2. BREAKER IS UL LISTED.
3. BATTERY CABINETS WITH BREAKERS ARE SHIPPED WITH BREAKER IN THE OFF/OPEN POSITION.
4. BREAKER ACCESSORY TERMINAL BLOCK IS SHOWN WITH OPTIONAL ACCESSORIES.
5. MAIN CABLES FROM BATTERY CABINET TO UPS ARE INCLUDED AND ARE SIZED FOR A "SIDE BY SIDE" LINEUP WITH THE UPS.
6. CABINETS ARE SHIPPED WITH A BATTERY JUMPER REMOVED TO BREAK STRING VOLTAGE FOR ADDED SAFETY IN SHIPPING.
7. GROUND CONNECTION IS #14-2/0 AWG MECHANICAL LUG.

CABLE KIT SIZING	
MAIN BREAKER MAX AMPS	MAINS TO UPS
125	1 AWG THHW
150	1/0 AWG THHW
225	4/0 AWG THHW

<b>BC41 BATTERY CABINET</b>		
FOR USE WITH GE TLE SERIES 40-80 KVA UPS		
<b>ELECTRICAL DRAWING</b>		
THE INFORMATION CONTAINED IN THIS DRAWING IS THE SOLE PROPERTY OF C&C POWER, INC. ANY REPRODUCTION WITHOUT THE WRITTEN CONSENT OF C&C POWER, INC IS PROHIBITED.		
DIMENSIONS ARE IN INCHES	INITIALS	DATE
TOLERANCES:	DRAWN JRL	11/15/2017
DECIMALS: .XX ±.13	CHECKED CH	11/15/2017
ANGLES: .XXX ±.082		
SCALE: NTS	SHEET 2 OF 2	

Manufactured by C&C Power for GE

© 2017 C&C POWER, INC. ALL RIGHTS RESERVED