

Front View

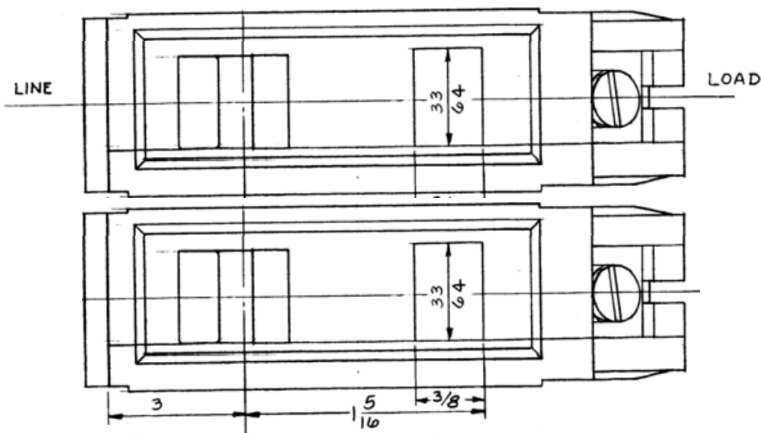

Bottom View

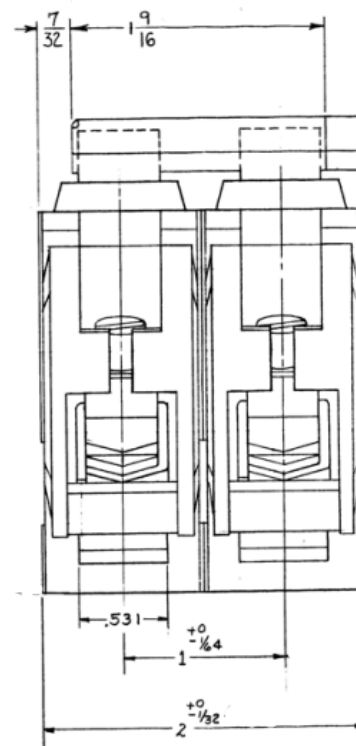

Side View

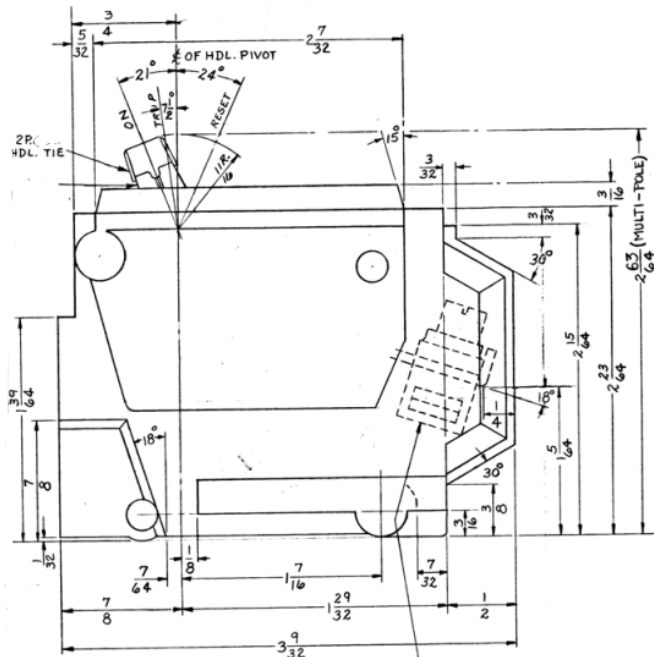

Breaker Amps	Load Side Wire Range Size
60A	(1) #8 - #3 (CU) or (1) #8 - #3 (AL)
70-100A	(1) #6 - 1/0 (CU) or (1) #4 - 1/0 (AL)
110-125A	(1) #2 - 2/0 (CU) or (1) #2 - 2/0 (AL)



imagination at work

90A 2PH THQL BREAKER 22K @ 120/240V
 FOR USE WITH GE METER STACKS - 125A SOCKETS

PUBLICATION #	CAT NO	DWG DATE	REV #
DEE-862	THHQL2190	10/16/2015	01