



DEH-40283 Installation Instructions

MANUAL MOTOR STARTER
 DISJONCTEURS MOTEURS
 MOTORSCHUTZSCHALTER
 INTERRUPTT PROTEZ MOTORE
 INTERRUPTOR AUTOMATICO
 DISJUNTOR PARA MOTOR
 MOTORBEVEILINGSSCHAKELAAR



WARNING: Disconnect power from source before installing, modifying or servicing.
ATTENTION: Couper l'alimentation avant installation, modification ou entretien.
WARNUNG: Netzspannung abschalten, bevor Installations, Montage oder instandhaltungsarbeiten durchgeführt werden.
ATTENZIONE: Togliere alimentazione prima dell'installazione e di qualunque manutenzione.
ATENCIÓN: Quitar la tensión antes del montaje y antes de hacer cualquier manipulación.
ATENÇÃO: Desligar antes de instalar, modificar ou reparar.
OPGELET: Netspanning onderbreken bij installatie, wijzigingen en onderhoud.

IP41/TYPE 1

IP55/TYPE 1,3R,12



145

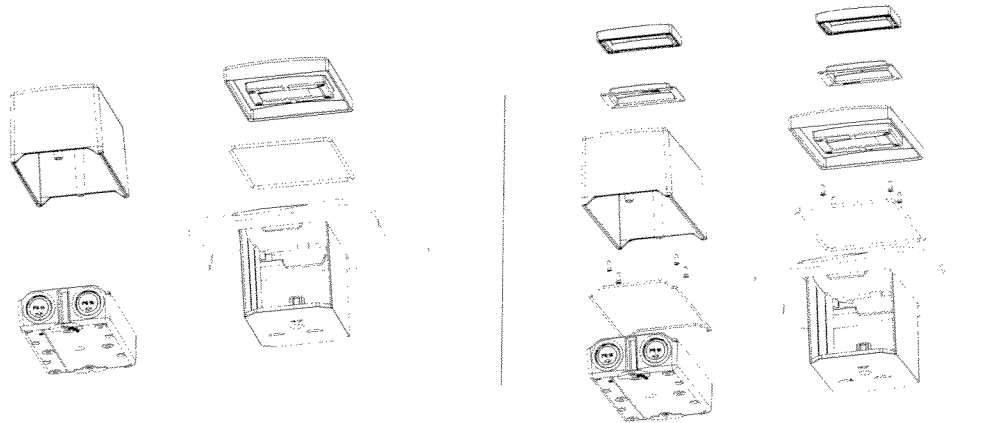

GPES41A

GPEF41A

GPES55A

GPEF55A

MOUNTING
 MONTAGE
 MONTAGE
 MONTAGGIO
 MONTAJE
 MONTAGEM
 BEVESTIGING

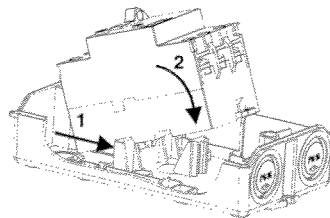

GPES_

GPEF_



GPEF_

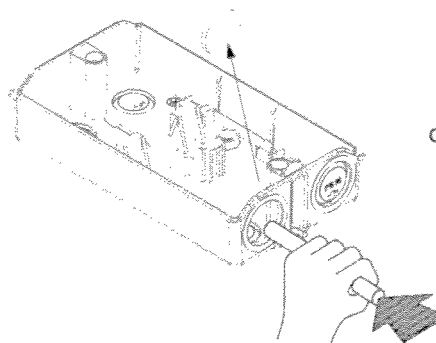

GPES_

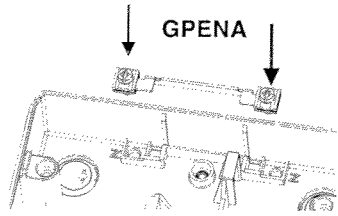

GPES_

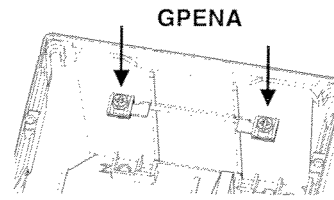

GPEF_

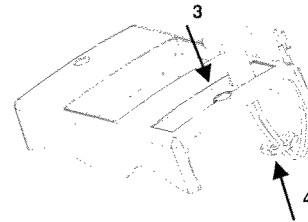
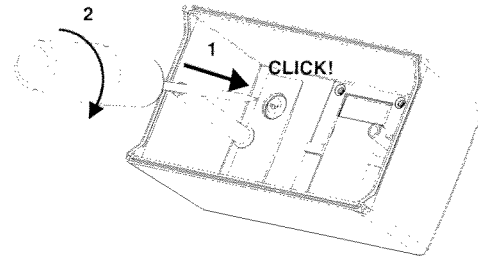
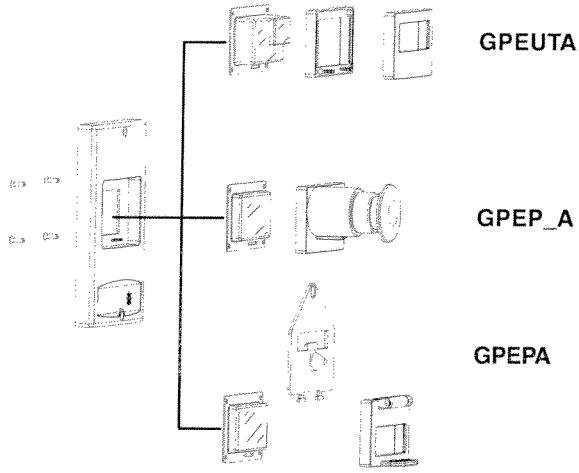

GPEL_

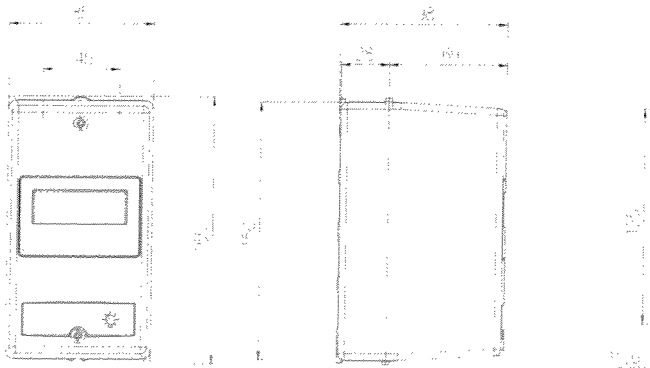

These instructions do not purport to cover all details or variations in equipment nor to provide for every possible contingency to be met in connection with installation operation or maintenance. Should further information be desired or should particular problems arise which are not covered sufficiently for the purchaser's purposes, the matter should be referred to the GE Company.