



DEH-41420 Installation Instructions

EntelliGuard®G Circuit Breaker Accessories

Introduction

Coil Signaling Contacts:

Coil Signaling Contacts indicate the status of the coil they are installed on. Coil Signaling Contacts consists of two switches thus enables the status of the coils thru trip unit and the secondary disconnect. Status switch thru secondary disconnect can be power rated or signal rated. Status switch thru trip unit is a signal rated.

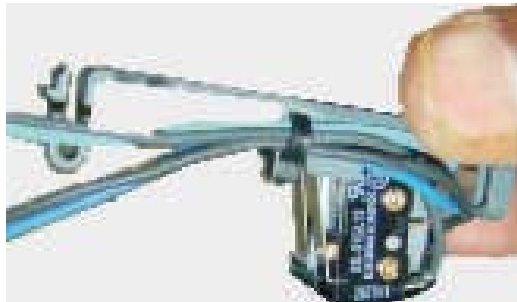

Coil Signaling Contacts

 **WARNING:** Before installing any accessories, turn the breaker OFF, disconnect it from all voltage sources, and discharge the closing springs.

 **AVERTISSEMENT:** Avant d'installer tout accessoire, mettre le disjoncteur en position OFF, le déconnecter de toute tension d'alimentation, et décharger les ressorts d'armement

CSC, Signal rated Contact:

			Cat no
AC Ratings	125Vac	0.1A	GCSP2R
DC Ratings	30Vdc	0.1A	

Use the following procedure to install Release Indication Contact accessory into the circuit breaker.

1. Verify that the rating on the Release Indication Contact identification plate matches the voltage rating required for the application, as listed in Table 1.

2. Turn the breaker off and discharge the closing springs by depressing the OFF and ON buttons in the sequence OFF-ON-OFF. Verify that the breaker OFF-ON indicator shows OFF on a green background and that the charge indicator shows DISCHARGE on a white background. If installing in a draw-out type breaker remove breaker from adaptor (cassette) before continuing.

3. Loosen the 6 screws on front cover (fascia) using a posidrive screw driver as shown in Fig 1.B

Table 1. Catalog Number and Ratings:

CSC, Power rated Contact:

			Cat no
AC Ratings	125Vdc	6A	GCSP1R
	250Vdc	6A	

Rotate the charging handle down and slide the front cover over the handle to remove the front cover as shown in Fig. 1.C.



Figure 1. (A) Front Cover (B) Screw Removal (C) Handle Rotation

4. Remove the existing coil from the mechanism.

5. Remove the coil cover by pressing the three snaps as shown in Fig. 2.



Figure 2. Removing the existing cover

6. Align the new cover with Release Indication Contacts on the coil as shown in Fig. 3.



Figure 3. Cover assembly

7. Guide the wires in the wire opening of the coil housing as shown in Fig. 4. Press the cover and ensure the 3 snaps are engaged with the openings in the coil housing.



Figure 4. Cover assembly

8. Tilt the coil forward and engage the front hooks into the mechanism top support plate as shown in the Fig. 5.

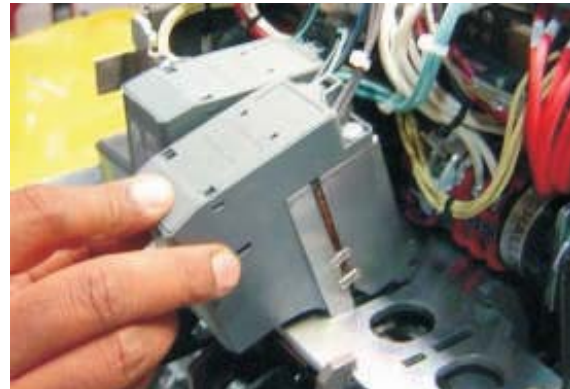

Figure 5. Assembly of coil

9. Plug the connector from the Release Indication Contact cover with the connectors from the harness of the trip unit as shown in Fig.6. While connecting ensure the coils are connected with the correct connectors from the harness such as marked as ST1/UV1/CC/ST2&UV2 from the respective coils.

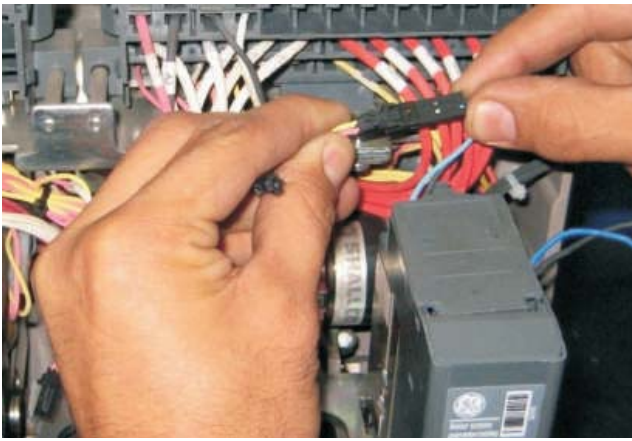

Figure 6. Assembly of connector

7. Tilt the device backwards until the rear hooks engage in the slots on the mechanism top support plate as shown in the Fig. 7.



Figure 7. Assembly of coil

8. Connect the input wire assembly plug to the terminal locations in the SD A block of the respective coil as shown in Fig. 8



Figure 8. Assembly of connector plug

9. Assemble the connector plug from the coils status switch cover to the terminal locations in SD block B as shown in Fig. 9.

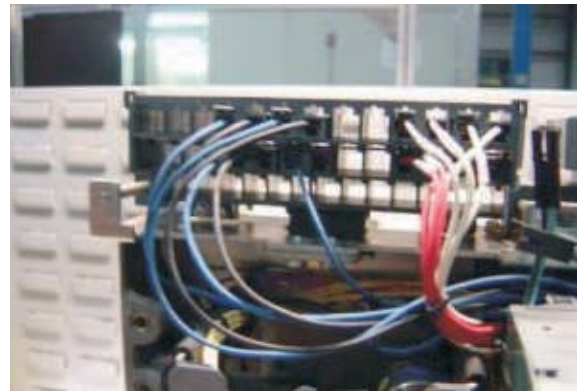

Figure 9. Assembly of connector plug

10. To reinstall the cover, rotate the charging handle down and slide the front cover over the handle to assemble the front cover to housing as shown in Fig. 10.



Figure 10.

12. Ensure the fascia is aligned properly with the trip unit and the pad lock features of the breaker.

13. Fasten the 6 mounting screws of fascia with the housing using a pozidrive screwdriver. Apply torque of 6 Nm (4.42ft-lbs).

Reference:

OPTIONAL CONNECTION SCHEME FOR COIL STATUS SWITCHES (BLOCK B)

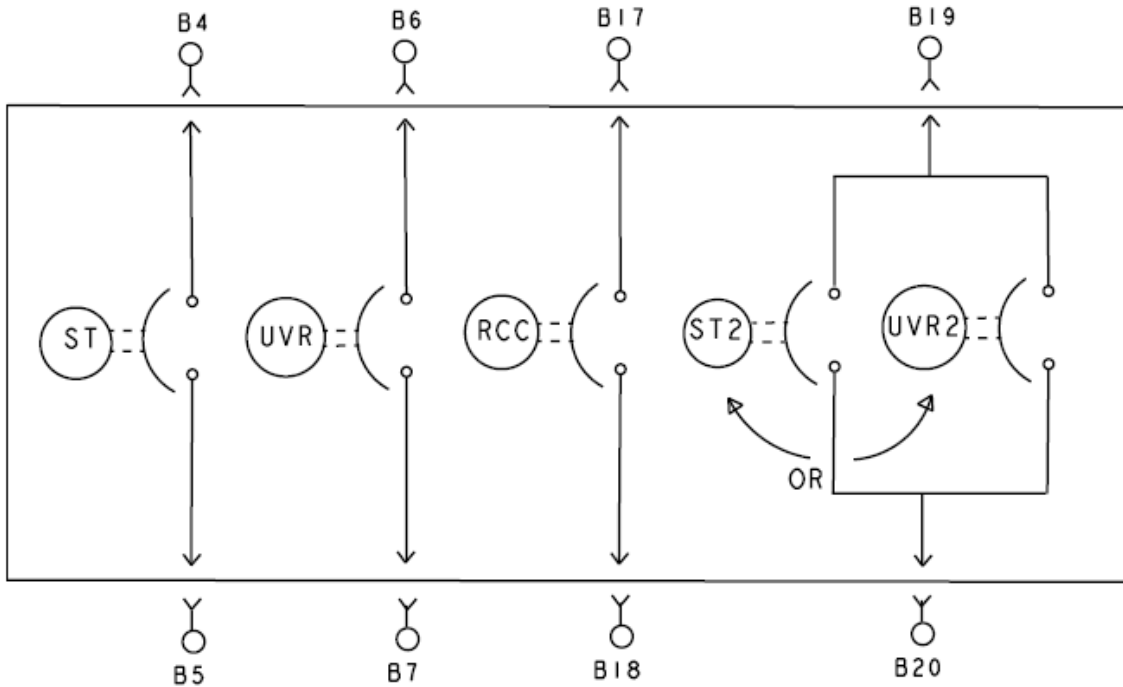

These instructions do not purport to cover all details or variations in equipment nor, to provide contingency to be met in connection with installation, operation, or maintenance. Should further information be desired, or should particular problems arise which are not covered sufficiently for the purchaser's purposes, the matter should be referred to GE.

GE
41 Woodford Ave, Plainville, CT 06062
www.geelectrical.com

© 2009 General Electric Company

