



EntelliGuard * R Retrofill Circuit Breakers 800-5000A

Installation Manual for R3 & R6 Type Retrofill Circuit Breakers replacing Drawout Letter Code B, D & F Legacy AKR Circuit Breakers used in AKD-8 & Substructures.

General Electric AKD-8 Low Voltage Switchgear is a free-standing assembly of metal-enclosed power circuit breakers. It may also be part of a single-ended or double-ended load center unit substation. This manual applies to EntelliGuard R breakers to be used in AKD-8 Switchgear & substructures found in OEM Equipment and GE Switchboards using legacy AKR circuit breakers of the following types: 800-2000A, AKR-#D-30/50/T50 circuit breakers in all Equipment types. 3200, 4000 & 5000A, AKR-#D-75/100/125 for AKD-8 switchgear, AKR-#B-75/100/125 types in OEM equipment and AKR-#F-75/100/125 types in GE switchboards.

(# is shown in place of a number which designates the trip unit type.)

Table of Contents

Preface	4
Hazards	4
Danger	4
Warning	5
Caution	5
Notice or Note	6
Warranty	6
Trademarks and Patents	6
Standards	6
Document Conventions	7
Related Publications	7
Service and Support: Service and support always available from GE Energy	7
Estimated Time to Complete Tasks	7
Product Specs	7
Weight (lbs.)	7
Views	8
History and Types	9
AKD	9
AKD-5—AK-25, AK-50, AKT-50, AK-75, AK-100	9
AKD-6—AKR-30/30H, AKR-50/50H/T50H, AKR-75/75H, AKR-100	9
AKD-8—AKR-30/30H/30L, AKR-50/50H/T50H, AKR-75/75H, AKR-100, AKR125	10
AKD-10—WPS-08, WPH-08, WPX-08, WPS-16, WPH-16, WPS-20, WPS-32, WPH-32 WPX-32, WPS-40, WPX-40, WPS-50, WPX-50	10
AKD-8—Retrofill Breaker	11
AKD-8-Breaker Models	11
AKD-8—Mechanical Drawings	13
AKD-8 Compartment	16
Interior View	16
Interior Components	17
Interior View	17
Interior Components	18
Unpack CB	19
Quality	20
Information Label	20
Product and Catalog Serial Numbers	20

Remove Circuit Breaker from Container	20
Inspect.....	20
Store Circuit Breaker	20
Check Before Installing.....	21
Clean and Grease Breaker	22
Modify Retrofill.....	23
Modify AKD-8—AKR30S Switchgear Compartment, Only	23
AKD-8 AKR-30S—Remove Glastic Sheet of compartment	24
AKD-8 AKR-30S —Modify Bracket.....	24
Install AKD-8 (800-2000A) Retrofill Breaker.....	25
AKD-8—Racked-In	28
Install AKD-8 & substructure type 3200, 4000 & 5000A Retrofill Breaker.	29
AKD-8—Racked-In	30
AKD-8—Install Accessories	31
AKD-8—Secondary Disconnects, Bullets.....	31
Wire Secondary Disconnect Assembly—AKR30/30H/50/50H/30L/30S,T-50H	36
AKD-8—Programmer Disconnects.....	38
Procedures	38
Wiring and Completion.....	41
AKD-8—Primary Disconnects (Contacts) or “Fingers”	41
Remove and Replace	42
Mechanical Views	44
Remove and Replace- AKR-75/100/125.....	45
Mechanical Views-AKR-75/100/125.....	48
AKD-8—Position Switch Actuator.....	48
AKD-8—Shutter Actuation.....	51
Install Door Interlock System.....	52
AKD-8— Kirk Key Interlock.....	55
Modify AKD-8—Switchgear Compartment	55
Cut Power to AKD-8—Switchgear.....	55
Rack Out AKD-8—Legacy/Existing CB	55
Check, Clean, Grease AKD-8—Compartment	55
Install New Door.....	56
Install AKD-8—Neutral Rogowski Current Transformer (CT).....	56
AKD-8—Neutral Disconnect Assembly.....	56
AKD-8—Neutral Disconnect Assembly, Bus Compartment.....	57
AKD-8—Rogowski Assembly Part Numbers.....	57

AKD-8-Neutral CT Adapter 400A-5000A.....	57
Procedures.....	58
AKD-8—Multi-Source Ground Fault	59

Preface

Hazards

The following important highlighted information appears throughout this document to warn of potential hazards or to call attention to information that clarifies a procedure. Carefully read all instructions and become familiar with the devices before trying to install, operate, service, or maintain this equipment.

Danger

This indicates a hazardous situation which, if not avoided, results in death or serious injury. A variety of electrical hazards warnings are displayed here and are applied to installation manuals. These are standard or generic alerts and labels that must be taken quite seriously when installing Retrofill circuit breakers in AKD switchgear and when working with potentially dangerous electrical equipment (*Table 1*). There are also dangers, pertaining to product safety, that need to be custom-written for particular or specific circumstances (*Table 2*).

Table 1. Generic Danger Alerts and Labels Used for Documentation and Dangerous Equipment	Table 2. Custom Danger Alerts and Labels Used for Documentation and Dangerous Equipment

Warning

This indicates a hazardous situation, which, if not avoided, would result in death or serious injury. A variety of electrical hazards warnings are displayed here and are applied to installation manuals. These are standard or generic alerts and labels that must be taken quite seriously when installing Retrofill circuit breakers in AKD switchgear and when working equipment that can cause injury, but may not be necessarily fatal (*Table 3*). There are also warnings, pertaining to product safety, that need to be custom-written for particular or specific circumstances (*Table 4*).

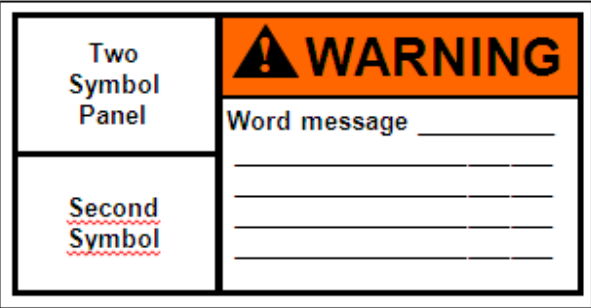
Table 3. <u>Generic</u> Warning Alerts and Labels Used for Documentation and Dangerous Equipment	Table 4. <u>Custom</u> Warning Alerts and Labels Used for Documentation and Dangerous Equipment
	

Caution

This pertains to a hazard that has a low level of risk, which means that if not avoided, it could result in minor or moderate injury. It also indicates that failure to comply with instructions may result in product damage. The label here requires a specific message that targets a special product or procedure (*Table 5*).

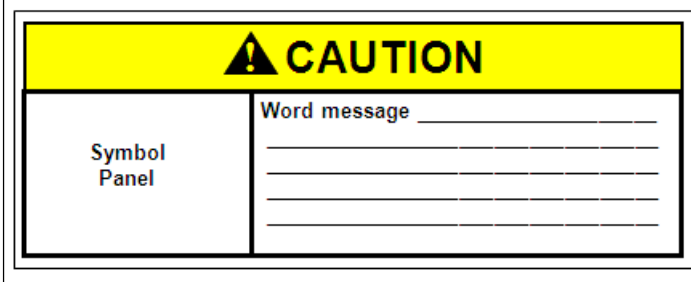
Table 5. <u>Custom</u> Caution Alerts and Labels Used for Documentation and Operating Equipment	
	

Notice or Note

This indicates important information in that it aids in job performance, that is, a notice or note is used to notify practices not related to personal injury (Table 6).

Table 6. Custom Notice Alerts and Labels Used for Documentation and Operating Equipment
<p>Not considered a safety label</p> <div style="border: 1px solid black; padding: 10px; margin: 10px auto; width: 80%;"> <div style="background-color: #0056b3; color: white; text-align: center; padding: 5px; font-weight: bold; font-size: 1.2em;">NOTICE</div> <p>Word message _____</p> <p>_____</p> <p>_____</p> <p>_____</p> </div>

Warranty

This document is based on information available at the time of its publication. While efforts have been made to ensure accuracy, the information contained herein does not cover all details or variations in hardware and software, not does it provide for every possible contingency in connection with installation, operation, and maintenance.

Features may be described herein that are not present in all hardware and software systems. GE Energy assumes no obligation of notice to holders of this document with respect to changes subsequently made. GE Energy makes no representation or warranty, expressed, implied, or statutory, with respect to, and assumes no responsibility for the accuracy, completeness, sufficiency, or usefulness of the information contained here-in. No warranties of merchantability or fitness for purpose shall apply.

Contact your local sales office if further information is required concerning any aspect of EntelliGuard R Circuit Breaker operation or maintenance.

Trademarks and Patents

- EntelliGuard* R
- EntelliGuard* TU
- EntelliGuard* Trip Unit
- EntelliGuard* G

Standards

Agency Certification	
Standard Number	Title
ANSI C37.13,16,17,20.1,50,51,59	Low-Voltage AC Power Circuit Breakers
NEMA SG 3,5	Low-Voltage Power Circuit Breakers
NEMA AB1	--
UL 1066	Low-Voltage AC and DC Power Circuit Breakers Used in Enclosures

Document Conventions

Topics and text are divided into primary, secondary, and tertiary paragraph headings.

Related Publications

Publication	Publication Number
Brochure	DEA-532
Snapshot	DEE-543
Installation Manual AKD-10	DEH-41550
Installation Manual AKD8	DEH-41549
Installation Manual AKD6 (800A-2000A)	DEH-41548
Installation Manual AKD5 (600A-2000A)	DEH-41547
Installation Manual AKD-5/6 (3000A/3200A/4000A)	DEH0005240
Accessory: Door Interlock (Door Interlock Kit)	DEH-41529
Accessory Retrofill Doors Assembly	DEH-41563
Accessory: Position Switch Plate & Position Switch Assembly & Wiring (Position Switch Kit)	DEH-41530
Accessory: Neutral Rogowski CT Disconnect (Neutral Assemblies)	DEH-41531
Accessory: Programmer Disconnects	DEH-41532
Accessory: Finger Clusters (Cluster Assemblies)	DEH-41533
Accessory: Secondary Disconnects	DEH-41534
FAQ	DEQ-171
Application Guide	DET-753
Guideform Spec	DET-754
Spare/Renewal Parts Guide	DET-755
Neutral CT Adapters	DEH0002400

Service and Support: Service and support always available from GE Energy.

Estimated Time to Complete Tasks

Wiring the secondary disconnects and verifying they match the switchgear cubicle may take 1 to 8 hrs depending on the complexity of the original breaker. Once the retrofill breaker is fully prepared, it should take about 20 minutes to swap out the old breaker and rack in the new EntelliGuard R retrofill circuit breaker if the proper lifting bar and hoist are available.

The EntelliGuard R retrofill, when ordered with 4 wire ground fault, will be equipped with a Neutral CT adapter. The adapter will modify the GE MicroVersaTrip type Neutral CT output to a Rogowski sensor output compatible with the EntelliGuard R's Trip Unit. With this device, it will **not** be necessary to change the neutral CT in the switchgear to a Rogowski sensor. Note: Neutral CT Adapters are designed to modify the signal from any Neutral CT which is compatible with a MicroVersaTrip or any newer GE Trip Unit type originally supplied by GE in AKD-8 switchgear from 1979 to 2015. GE type TSVG... neutral CT's are compatible. The old GE SST Neutral CT's are not. Neutral sensors working with any Non-GE trip units installed as the result of a Trip unit conversion kit should be assumed to be incompatible with the NCT Adapter.

Product Specs

Weight (lbs.)

Retrofill Breaker	Weight	Cover Box Wt.	Pallet Wt.	~ Accessories Wt.	~ Shipping Weight
AKR30S-800A	184	11	24	2	221
AKR-30/30H-800A	230	11	24	2	267
AKR-30L-800A AKR-50/50H-1600A	270	11	24	2	307
AKRT-50H-2000A	270	11	24	2	307
AKR75/AKR75H-3200A	600	15	30	2	647
AKR100-4000A	625	15	30	2	672
AKR125-5000A	700	19	38	2	759

Views

Typical R3 & R6 EntelliGuard R retrofit breakers are shown below. All breakers are drawout types. Each breaker is constructed by permanently joining an EntelliGuard G circuit breaker in a steel frame, installing primary and secondary disconnects and driving drawout racking cams thru what looks like the EntelliGuard G Cassette's front dashboard.

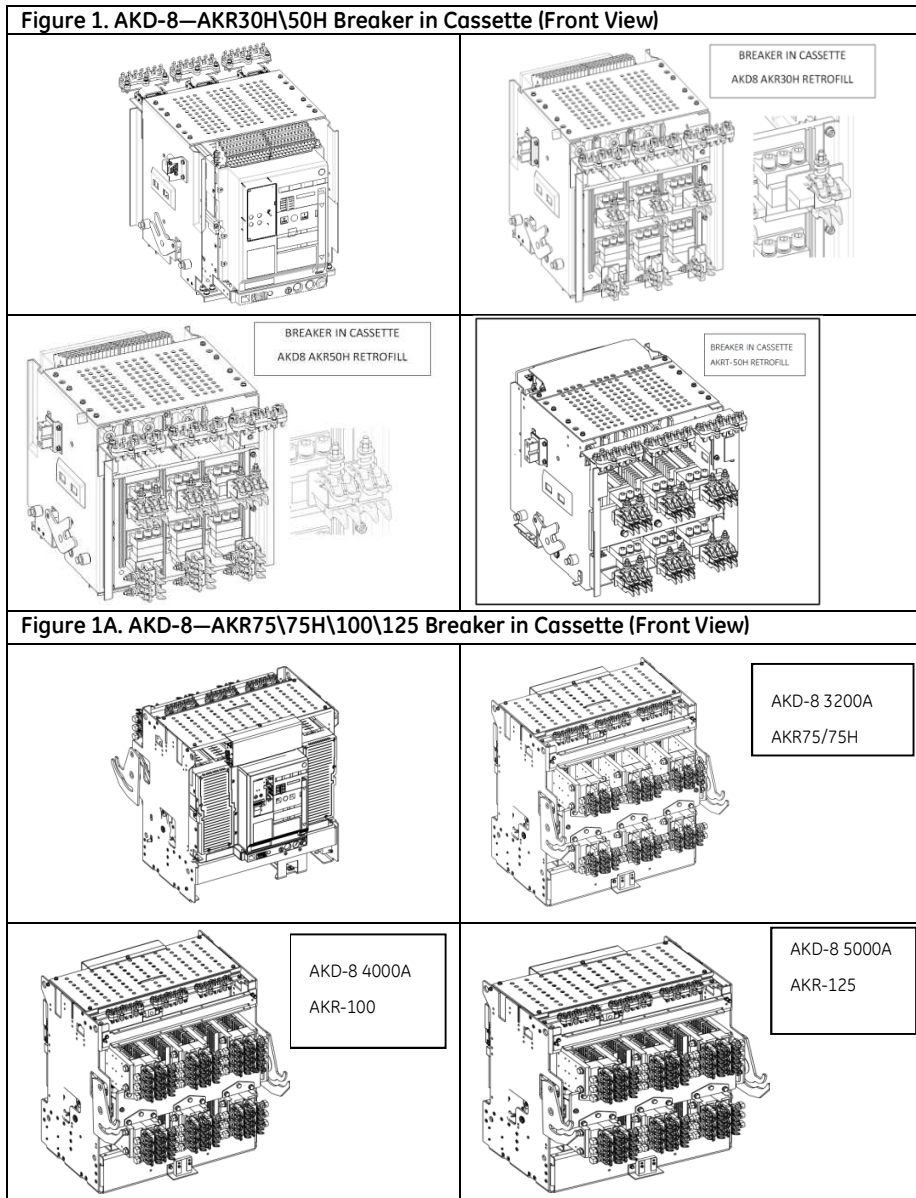

The EntelliGuard R Circuit Breaker is suitable for application on power systems up to 635 VAC 50/60 Hz.

History and Types

AKD

AK—Power Circuit Breaker Equipment
D—Drawout circuit breaker construction

Manufactured from 1951 to 1975, all bolted, copper bus design, all drawout breakers—AK-1, -2, -3, -15 / 25 / 50 / 75 / 100; with a 4000A-max bus rating. Breakers had a ratcheting drawout mechanism, with an open-door drawout. Breakers were painted ANSI 61, light gray, manufactured in Philadelphia from 1951 to the mid-60s and in Burlington, Iowa from the mid-60s to 1975.

The breaker compartment was a welded assembly, and the equipment frame was bolted. Breaker boxes were stacked to make a vertical section with equipment frame around the breaker boxes. There were no bus compartment barriers, just an open bus design. Ring silver-plating was applied to bolted connections.

AKD-5—AK-25, AK-50, AKT-50, AK-75, AK-100

Manufactured from 1960 until 1977, the aluminum bus had copper that was “flash-butt welded” to the aluminum at bolted connections. During that time, AK-2A, 3A -25 / 50 / T50 / 75 / 100 (“A” signifies AKD-5 drawout) were produced. Breakers up to 2000A had primary finger clusters. 3000 & 4000A breakers had a circular primary finger cluster arrangement in the switchgear compartment. Pull-lanyard drawout mechanism in the switchgear on early designs was replaced by a single jackscrew mechanism and then later replaced by a double jack-screw mechanism. Featured is a closed-door, drawout with inner house breaker compartment, where door moves with the breaker as it is racked in or out. Two bus levels are available with a ring bus used at 4000A. Particulars include: welded/riveted frame, bus compartment barriers, line/load separation barriers on mains and ties, isolation barriers on transformer transitions, copper runbacks on feeder breakers, ring silver-plating on copper, and aluminum bus un-plated (welded connections). The switchgear is painted sand-gray (beige), with some instrument doors painted blue. AKR-30/50 in 22”-wide sections were introduced in AKD-5 construction, early 70s. AK25s and AK50s were also available as substructure kits for OEMs to build around customer gear.

Note: All legacy AK & AKR breakers have a draw out letter code “A”. EntelliGuard R Retrofill breakers for this gear will have a catalog number beginning with **R1** for AK replacements or **R2** for AKR-30/50 replacements.

AKD-6—AKR-30/30H, AKR-50/50H/T50H, AKR-75/75H, AKR-100

AKD-6 was manufactured in Salisbury, NC from 1977 to 1981. Some AKD-5s, which were built in Salisbury from 1975 until 1977, got name-plated as AKD-6. There is no “flash-butt” welded aluminum to copper. Aluminum bus is tin-plated and bolted at shipping splits (but welded everywhere else). Copper bus design has ring silver plating at bolted joints. AKR-75 / 100s were introduced during this time. Stab-and-finger connections on 3200A and 4000A breakers were improvements, versus the round the primary disconnects on the AKD-5. The 4000A breaker was also narrowed to same width and phase-phase spacing as the 3200A.

The AKD-6 uses inner-house drawout breaker compartments on the 800—2000A breaker compartments. They are painted ANSI 61 light gray and breakers have ECS or SST trip units.

AKD-6 should mark a shift away from all AK breakers and to AKR breakers. The AKR-30/50/50H/T50 breakers used in AKD6 have a shallow 1” steel front escutcheon are drawout letter code “A” i.e. AKR-4A-30 and will be replaced by an EntelliGuard R with a catalog number beginning with **R2**. The AKR-30/50/50H/T50/75/100 breakers sold to OEMs for their switchgear have a 5” deep plastic front escutcheon & spring loaded sliding “picture frame”. These are draw out letter code “B” i.e. AKR-4B-30 which will be replaced by an EntelliGuard R with a catalog # beginning with **R5** up to 2000A frame size and **R6** for 3200 & 4000A frame sizes.

The AKR-75/100 breakers used in AKD-6 have a shallow 1" steel front escutcheon and vertical primary fingers. They are drawout letter code "C" i.e. AKR-4C-75 and will be replaced by EntelliGuard R with catalog number beginning with R2

AKD-8—AKR-30/30H/30L, AKR-50/50H/T50H, AKR-75/75H, AKR-100, AKR125

AKD-8 was manufactured in Salisbury, NC from 1980 to 1984 and in Burlington, Iowa from 1984 to 1999. It was mostly replaced by AKD-10 in 1999 to 2000 but was available thru 2015. Model 1 and 2 have extruded vertical bus. Model 2 was introduced in 1983 to accommodate revised wire harness routing. Model 3 was introduced in 1991, using a flat bar vertical bus. AKR breakers use MicroVersaTrip 9, MVT RMS9, EPIC, MVT Plus, MVT PM, or EntelliGuard TU trip units. Aluminum bus was removed from the design in 1996 in favor of the standard tin-plated copper bus (silver plated optional).

The AKR-30/50/50H/T50 breakers used in AKD8 have 5" deep plastic front escutcheon & spring loaded sliding "picture frame". They are drawout letter code "D" i.e. AKR-7D-30. In AKD-8, most 800-2000A breakers are "feeder" breakers with vertical lower stud & primary disconnect fingers clusters, but 800-2000A breakers designated as "Main" breakers, have horizontal lower finger clusters, which is the same as "D" letter code breakers sold to OEM's. A lower stud rejection bracket differentiates between lower stud orientations. EntelliGuard R breakers with a catalog number beginning with **R3** replace an AKR-30/50/50H/T50 breaker with vertical lower stud & fingers. EntelliGuard R breakers with a catalog number beginning with **R6** replace an AKR-30/50/50H/T50 breaker with horizontal lower stud & fingers.

AKR-75/100/125 circuit breakers used in AKD-8 switchgear have a 5" deep plastic front escutcheon & spring loaded sliding "picture frame" similar to the small frame breakers. The positions DISC/TEST/CONN are shown on the side of the front escutcheon by position of the sliding "picture frame". The GE AKD-8 breakers have a drawout letter code "D". OEM versions are drawout letter code "B" and GE Switchboard versions are drawout letter code "F". "B" & "F" breakers only differed by appearance items. All Primary disconnect stabs are vertically oriented. The AKR-125 is a 5000A breaker that had cooling fan. It was release in 1995. None of the retrofill breakers utilize fans.

EntelliGuard R breakers with a catalog number beginning with **R3** replace and AKR-75/100/125 breakers in AKD-8 switchgear. EntelliGuard R breakers with a catalog number beginning with **R6** replace and AKR-75/100/125 breakers in OEM switchgear or switchboards or GE Switchboard which all utilize an OEM substructure mounted on a shelf. The **R6** breakers will require a different door with a "bump inward" as the original compartment depth is 1.4" greater than AKD-8.

AKD-10—WPS-08, WPH-08, WPX-08, WPS-16, WPH-16, WPS-20, WPS-32, WPH-32 WPX-32, WPS-40, WPX-40, WPS-50, WPX-50

AKD-10 was manufactured in Burlington, IA from 1999 thru 2015. The switchgear compartment sizes and main & vertical bus arrangements are the same as AKD-8 Model 3. The compartments have pull-out rails. AKD-10 uses WavePro * drawout-only style breakers. All breakers have 4 rollers which align with the compartment rails. The secondary control wiring for all functions is connected thru either one or two 36 point secondary disconnects with gold plated contacts. Secondary control wiring terminates at fixed standard locations on the 36 point disconnects. Each breaker has a pump style manual charging handle and manual push OPEN and Push CLOSE buttons. The front escutcheon is 5" deep with a sliding picture frame, but is wide enough so the trip unit and new style bell alarm are visible thru the front door of the switchgear. EntelliGuard R breakers with a catalog number beginning with **R7** will replace a WavePro breaker with a catalog number beginning with WE or W1. EntelliGuard R breaker with a catalog number beginning with **R8** will replace a WavePro breaker with a catalog number beginning with WS or W2. Note GE Switchboard plants initially shipped "WS" style breakers and later shifted to "WE" style breakers to be consistent with GE Switchgear from Burlington, Iowa. The 5000A breaker had cooling fans. None of the retrofill breakers utilize fans.



AKD-8—Retrofill Breaker

AKD-8-Breaker Models

The Table 7 depicts the key differences between Model 1 & 2 AKD8 Retrofill breakers (800-1600A).

Note: All features of Model 2 (800-1600A) Retrofill breakers are incorporated in all the 2000A breakers.

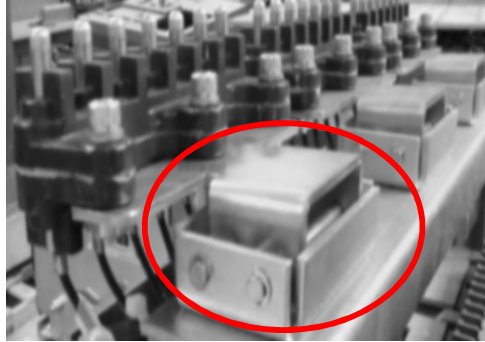
Table 7. AKD-8—Model 1 & 2 Retrofill Breakers

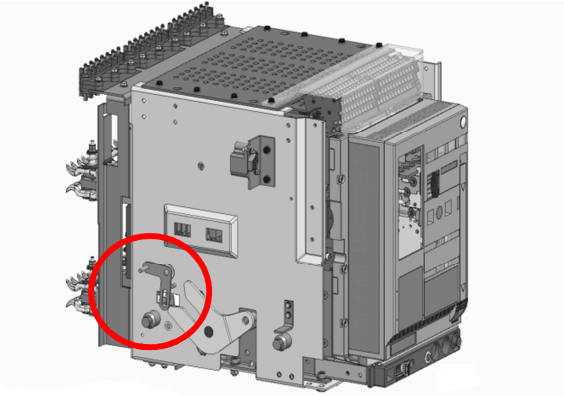
Feature	Model 1 Retrofill Breaker (800-1600A)	Model 2 Retrofill Breaker* (800-1600A & 2000A) – except AKR-30S
Secondary Disc Bullet mounting	Secondary disconnect bullets mounted on spring loaded bracket assembly 	Secondary disconnect bullets mounted directly on metal bracket 
Kirklock Actuator	Not provided –Kirklock Mechanism (to achieve kirklock feature through existing compartment installed kirklock lever) is not present	 AKD-8 Compartment Kirklock can lock out the Model 2

*EntelliGuard R Retrofill breakers for AKR-30S have not been redesigned with model 2 features.

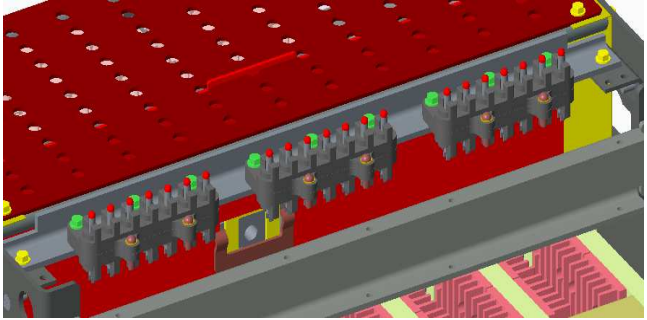
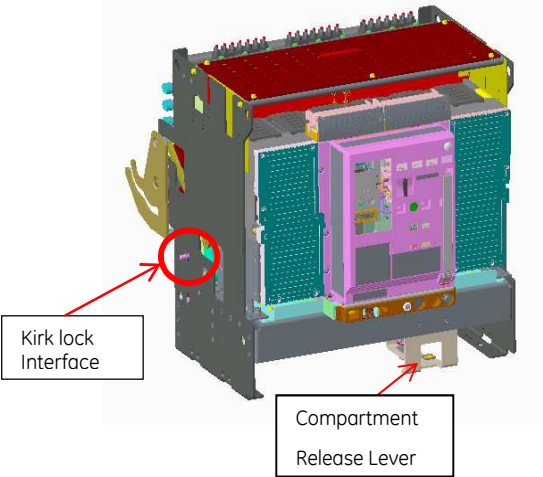
Table 7A. AKD-8—Retrofill Breakers (AKR75/75H,AKR100,AKR125)	
Feature	Retrofill Breaker (3200-5000A)
<p>Secondary Disc Bullet mounting</p>	<p>Secondary disconnect bullets mounted directly on metal bracket as on the legacy AKR breakers</p> 
<p>Kirk lock Actuator/ Compartment Release lever</p>	<p>AKD-8 compartment Kirk lock can lockout all 3200-5000A EntelliGuard R types</p> 

AKD-8—Mechanical Drawings

The following engineering or assembly drawings describe the layout and dimensions of the AKD-8 Retrofill breaker (Figure 2, Figure 3, Figure 4, Figure 5).

Figure 2. AKD-8—AKR30/30H—Retrofill Breaker, Dimensioning

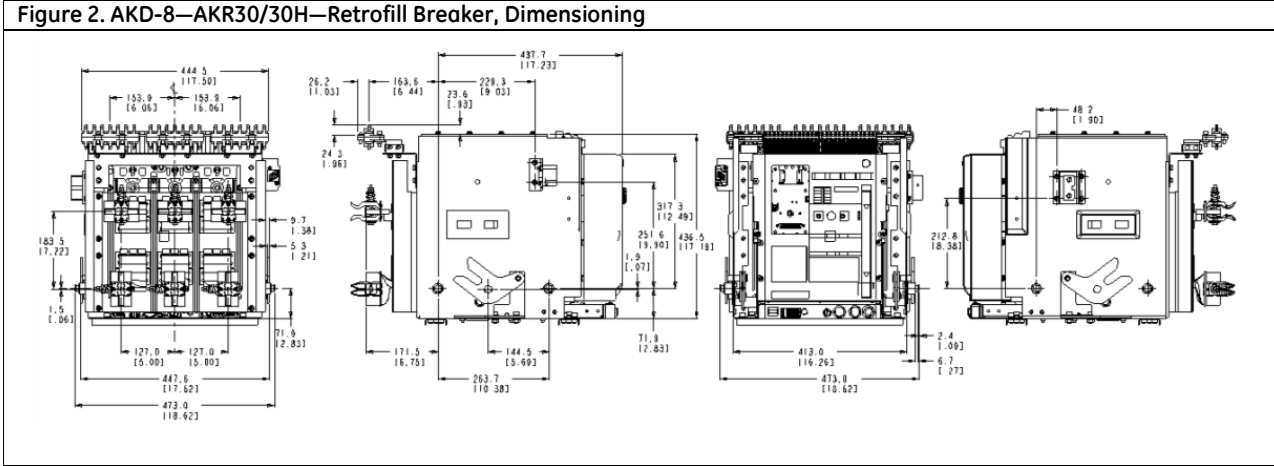

Figure 3. AKD-8—AKR30S—Retrofill Breaker, Dimensioning

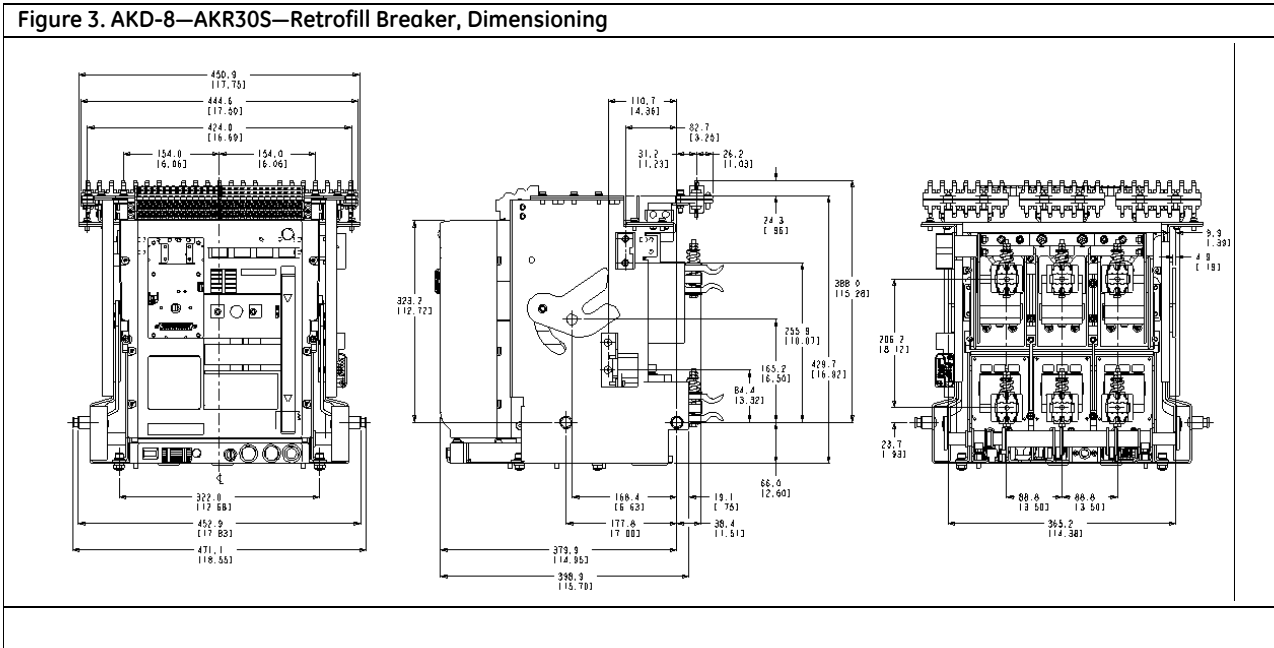

Figure 4. AKD-8—AKR50/50H/30L—Retrofill Breaker, Dimensioning (Model 1) R3 type

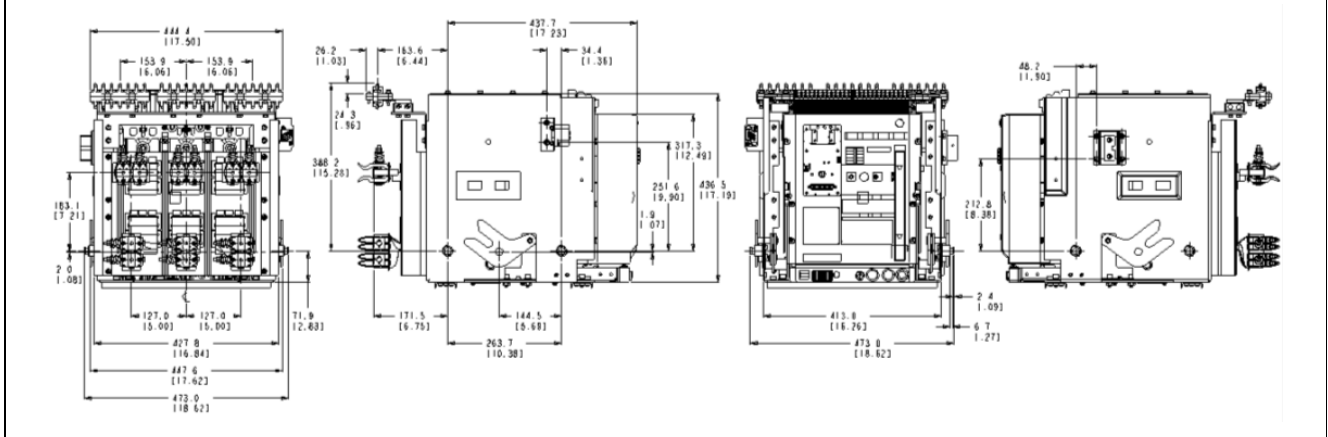

Figure 5. AKD-8—AKR50/50H/30L/AKRT-50H—Retrofill Breaker, Dimensioning (Model 2)

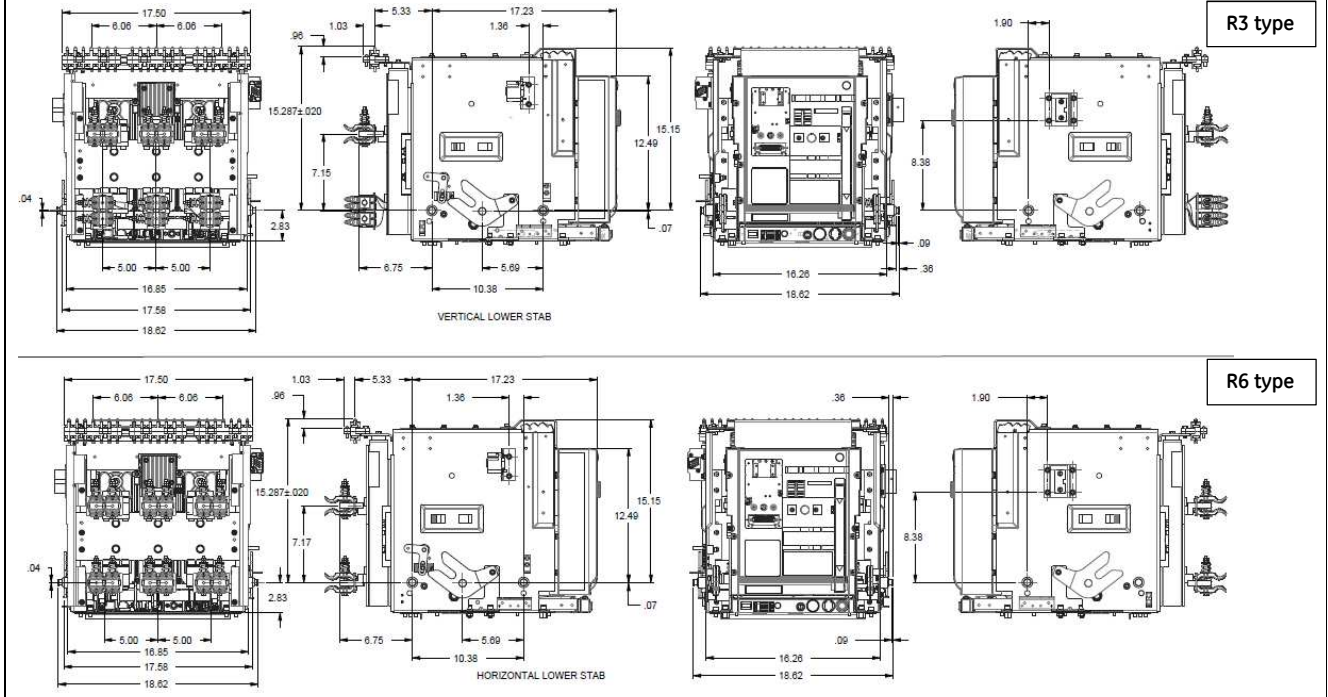

Figure 5A. AKD-8—AKR75/75H/AKR-100—Retrofill Breaker, Dimensioning

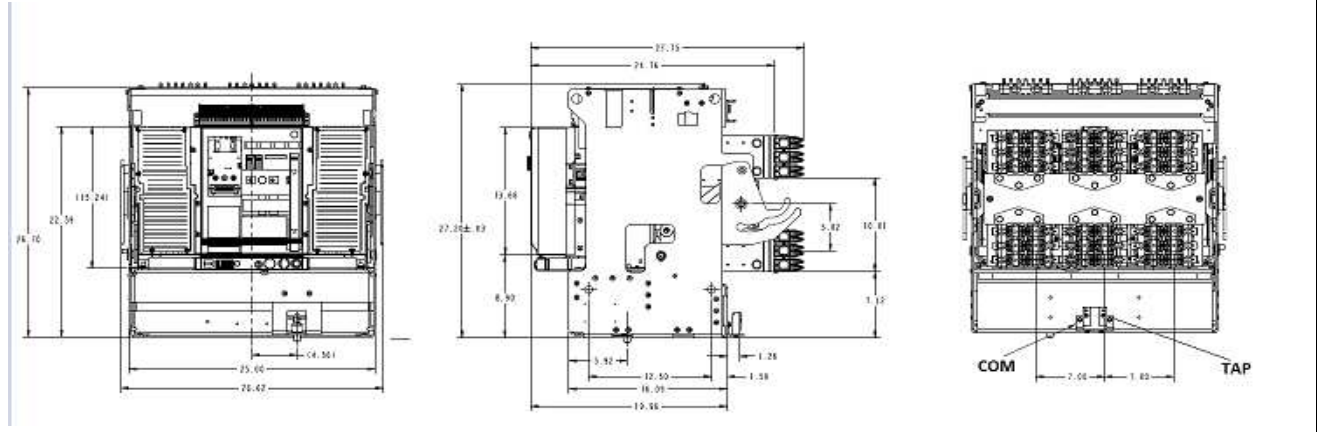
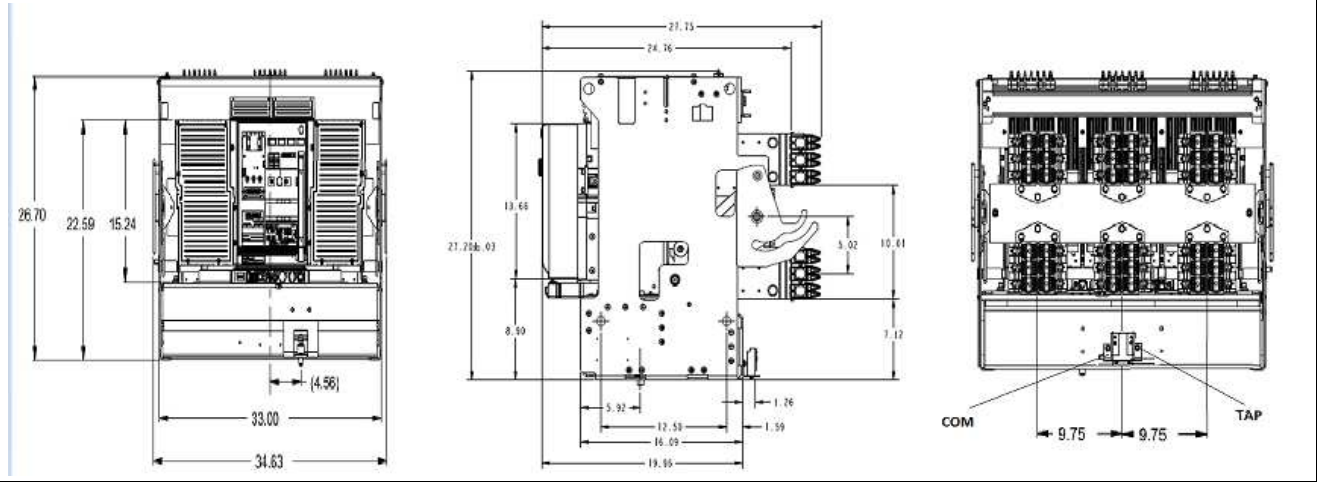

Figure 5B. AKD-8—AKR-125—Retrofill Breaker, Dimensioning



AKD-8 Compartment

Interior View

The figures (Figure 6, 7, 8 & 9) below present a Typical AKR-30/50/T50 AKD-8 compartment.

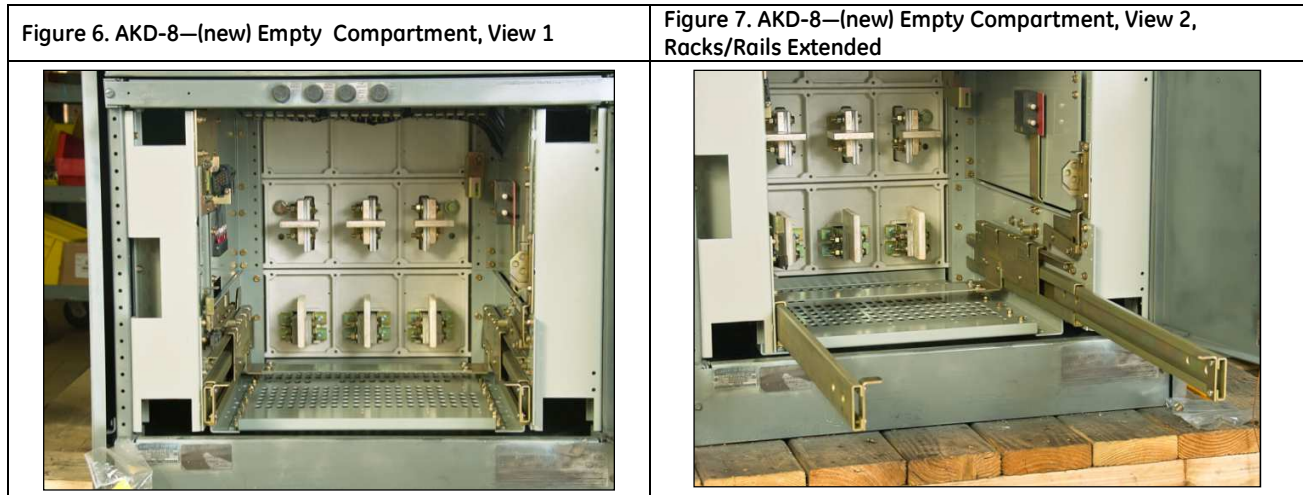
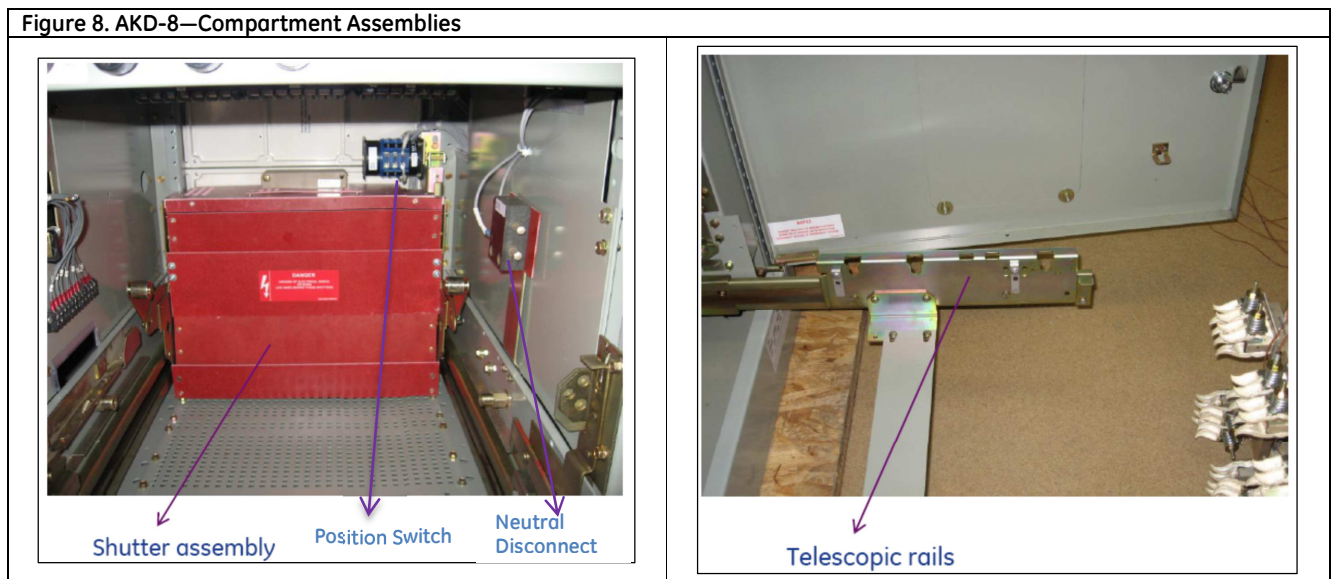
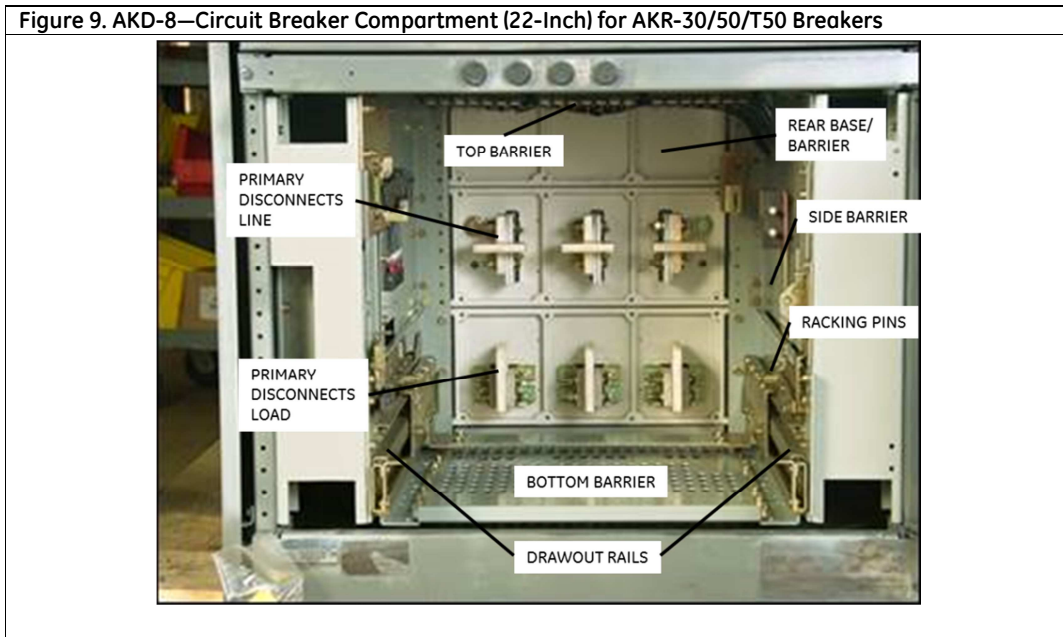

Figure 8 is a photo of the interior of the AKD-8. The photos point out the shutter assembly and telescopic rails in the AKD-8.



Interior Components

Figure 9 points out the major components of an AKD-8 compartment.



Interior View

The figures Figure 6A, 7A, 8A & 9A below present a Typical 30" AKR-75/100 AKD-8 compartment. (AKR-125 is similar but 38" wide)

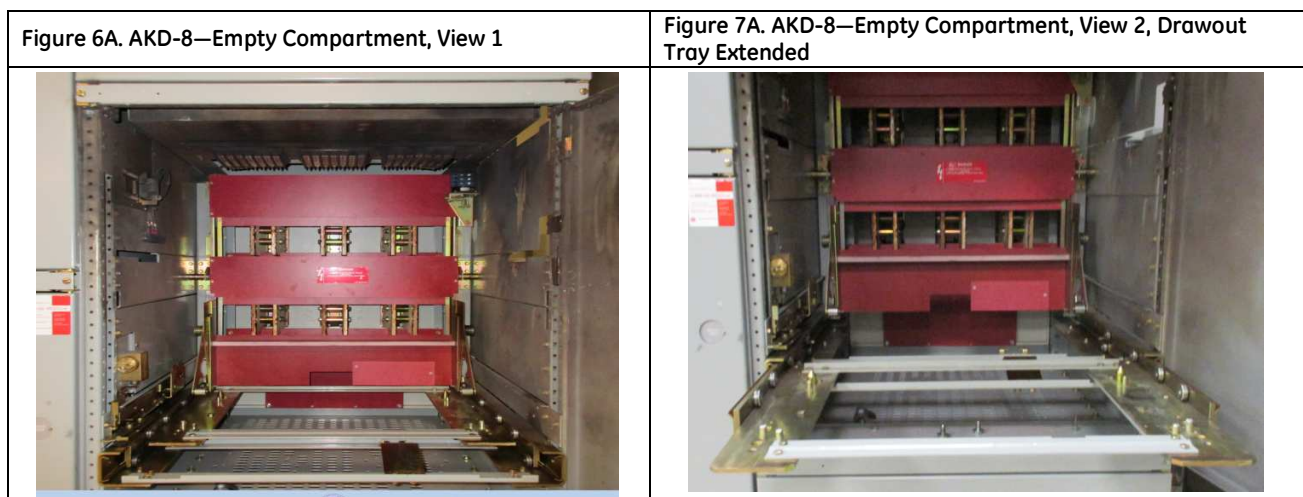
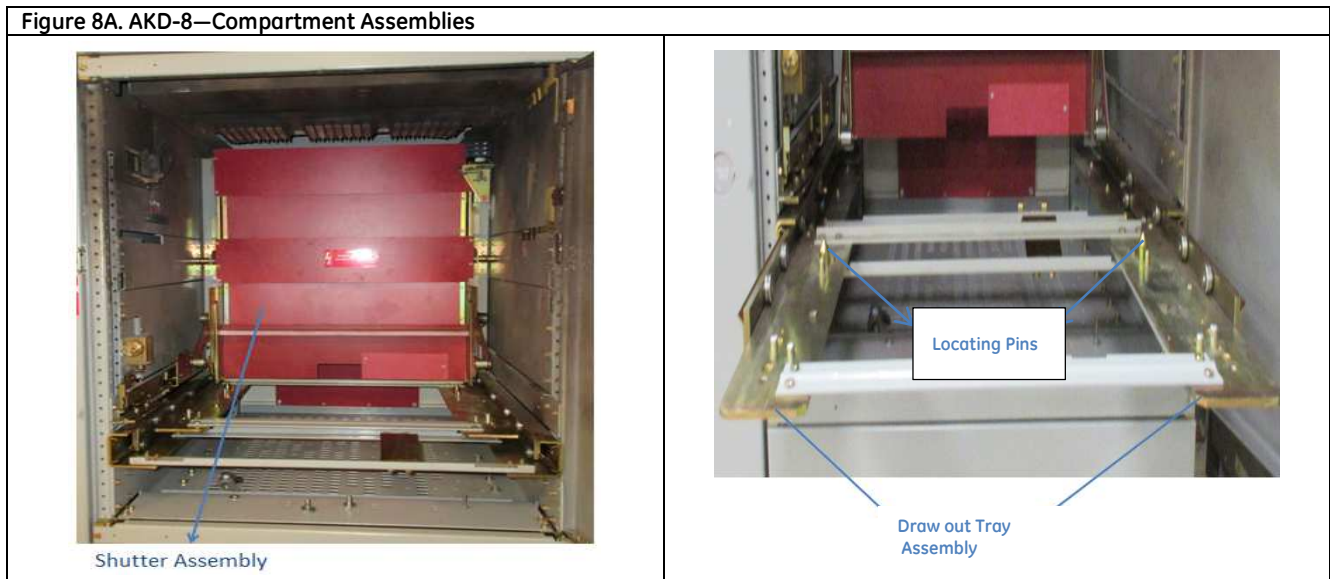
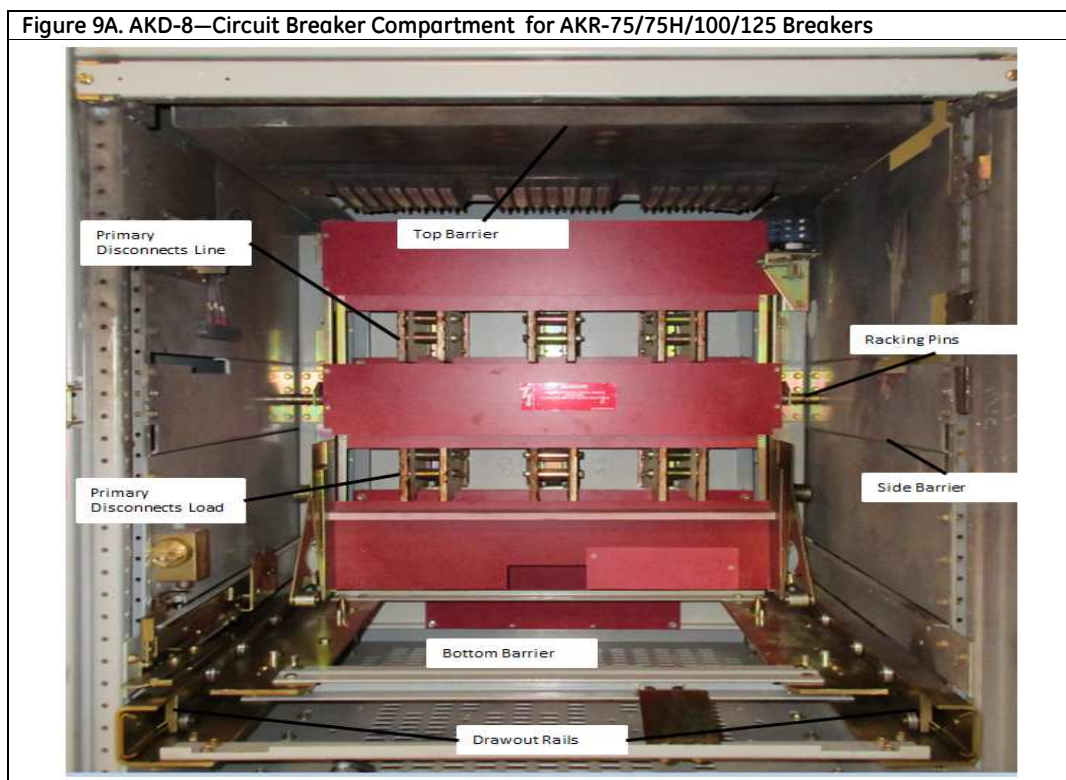

Figure 8A is a photo of the interior of the AKD-8. The photos point out the shutter assembly and Draw out tray assembly in the AKD-8.



Interior Components

Figure 9A points out the major components of an AKD-8 compartment.



Unpack CB



- Turn off all power to switchgear. Tagout and lockout main source, up-stream or main breaker.
 - Failure to comply with these instructions will result in death or serious injury from severe burns caused by arc flashing that has exceedingly high temperatures.
 - Always wear personal protection equipment according to OSHA standards and appropriate to the severity of potential burns.
-
- Ensure only qualified personnel install, operate, service, and maintain all electrical equipment.



Falling Object

- Do not walk or remain under any heavy assembly while hoisted above head as the chains securing the assembly may give way
-
- Ensure lifting equipment has capability for device being lifted.
 - Wear hard hat, gloves, and safety shoes.
 - Failure to comply with these instructions could result in serious injury.



PRODUCT DAMAGE

- Ensure circuit breaker and its accessories are always used within their designated ratings.
 - Do not allow the circuit breaker to hit a hard surface while handling.
 - Do not drag or slide the circuit breaker across a hard or rough surface
-
- A factory-installed rejection feature prevents mismatching circuit breakers and cassettes/substructure, preventing the insertion of a circuit breaker with a lower rating into a higher rated cassette/substructure, or the insertion of a higher rated circuit breaker into a lower rated cassette/substructure.

By following the procedures below, you should be able to install the breaker with minimum effort and time.

Quality

All EntelliGuard R circuit breakers have been designed and manufactured to ANSI standards. The design was based on the original requirements of the legacy switchgear and breakers. The product is manufactured in Burlington, Iowa; and is inspected using some of the same master gauges used on the legacy AK, AKR breakers to confirm electrical and mechanical performance, including rejections-features.

Information Label

On the side wall of each circuit breaker there is a factory-assembled label that details all features included on both the circuit breaker and on the trip unit.

Product and Catalog Serial Numbers

Product and catalog serial numbers should be kept handy when communicating about the circuit breaker. Each circuit breaker has a unique serial number located on the left side (viewed from front) of the front fascia.

Remove Circuit Breaker from Container

Inspect

1. Inspect the shipping container for obvious signs of rough handling and/or external damage incurred during transportation.
2. Record any observed damage for reporting to the carrier. Ensure all recorded reports and claims include the order number and name plate information.
3. Remove the banding straps and lift the top cover.
4. Remove all packaging material.
5. Remove all product documentation and store properly.
6. Unscrew the mounting screws that fasten the circuit breaker to the bottom of the shipping pallet and remove the circuit breaker.

Store Circuit Breaker

	<p>PRODUCT DAMAGE</p> <ul style="list-style-type: none">• Do not store circuit breaker in corrosive environments above LC1 (sea salt mist) and G1 as per ANSI/ISA-S71.04-1985.• Ensure circuit breakers are stored in a clean, dry location, in their original packaging.• Failure to comply with these instructions may result in product damage.
---	---

If you decide not to install the Retrofill breaker until a later time, then you can store it away for installing it later.

1. Store the circuit breakers in a clean, dry location in an upright position.
2. Make sure that the breakers are properly supported to prevent bending of the studs or damage to any of the breaker parts. Do not remove any protective grease until the assemblies are ready to be installed. A covering of draft or other non-absorbent paper prevents dust from settling on the breakers.
3. If breakers are not to be placed in service at once, remove them from their shipping cartons and thoroughly inspect them.
4. If everything is in satisfactory condition, replace the breakers in their shipping cartons for storage. If it is necessary to store the equipment for any length of time, use the following precautions to prevent corrosion or deterioration:
 - Uncrate the equipment and check thoroughly for damage.
 - Store in a clean, dry, rodent-free location with moderate temperature and provide protective coverings to prevent dirt, water, or other foreign substances from entering the breaker.
 - If dampness or condensation is encountered in the storage location, heaters can be used to prevent moisture damage.

Use Lifting Truck

1. Use a lifting truck to lift and mount the assembly to avoid personal injury and damaging the breaker.
2. Contact the nearest sales office for availability of a hoisting device.

Check Before Installing



- It must be ensured that the supply power to the compartment is turned off/ compartment is de-energized for all the incoming and outgoing circuits of the LVS prior to any work being conducted on it.
- During the installation and related work on the equipment, it must be ensured that the operator is using the prescribed PPE for the specified tasks.

- **Ensure only qualified personnel install, operate, service, and maintain all electrical equipment.**

These breakers are supported on a rollout track in the same manner as the AKR breakers. Racking cams on both sides of the breaker frame engage the drawout mechanism pins fastened to both sides of the compartment.

1. Check to see that the breaker or breakers match their respective compartments. Look on the breaker summary sheet, the front view drawings, breaker nameplate, and on the identification card on the breaker shipping carton.

2. To locate the breaker for its proper compartment, refer to the breaker location list on the front view drawing. Find the proper breaker by the identification card on the breaker carton, or the mark number on the breaker nameplate. All identical legacy breakers have the same mark number.

Clean and Grease Breaker

1. Before installing or operating a breaker, refer to the breaker instruction manual for pre-operation inspection and test.
2. Check thoroughly for any damaged or loose parts and for any dirt or foreign matter which may be in the breaker.
3. Clean those areas if necessary with a clean, lint-free rag and isopropyl alcohol or acetone.
4. Be sure to apply a thin film of electrical grease DH0HD38 (Mobilgrease 28) to the primary disconnect fingers (*Figure 10/10A*). GE Part #193A1751P1 is a 1 oz. tube of Mobilgrease 28.

Figure 10. AKD-8—Primary Contacts or “Fingers” (Apply Grease)

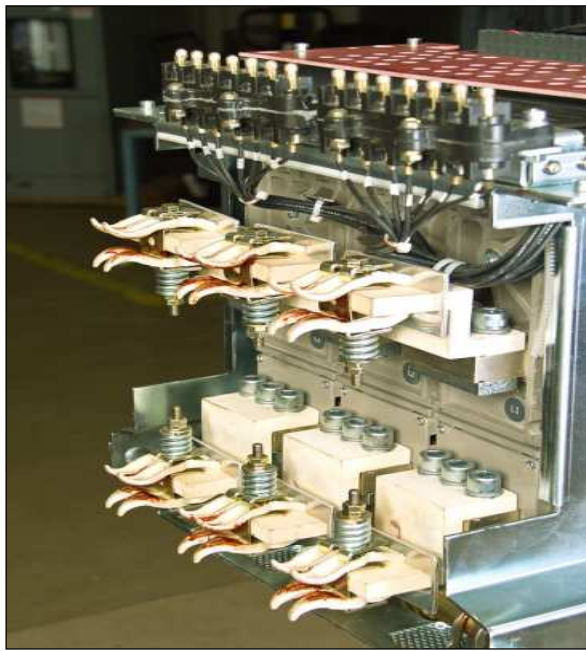
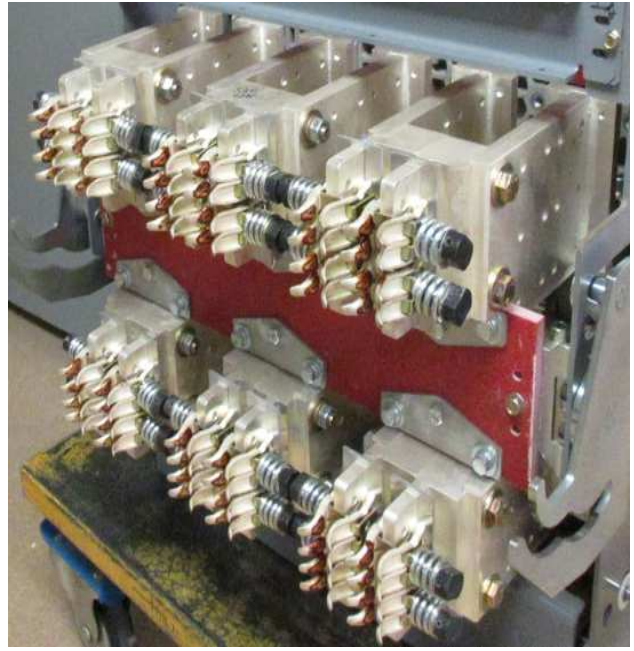





Figure 10A. AKD-8—(3200-5000A) Primary Contacts or “Fingers” (Apply Grease)



Modify Retrofit

	<p>WIRING</p> <ul style="list-style-type: none">• Before installing the breaker, the secondary disconnects must be wired to the EntelliGuard Breaker.• Wires with wire markers are provided on the Retrofit. Make sure that the switchgear wiring connection points match up with the original wiring of the cubicle. This ensures that all wiring connections are properly made.• Wrong connections will cause the breaker to malfunction.
---	--

Modify AKD-8—AKR30S Switchgear Compartment, Only

	<ul style="list-style-type: none">• It must be ensured that the supply power to the compartment is turned off/ compartment is de-energized for all the incoming and outgoing circuits of the LVS prior to any work being conducted on it.• During the installation and related work on the equipment, it must be ensured that the operator is using the prescribed PPE for the specified tasks.
	<ul style="list-style-type: none">• Ensure only qualified personnel install, operate, service, and maintain all electrical equipment.

AKD-8 AKR-30S—Remove Glastic Sheet of compartment

Figure 11. Remove Glastic Sheet – AKR-30S only



The AKD-8 AKR30S switchgear compartments need this particular attention. The glastic sheet has to be removed (Figure 11).

In some cases, however, it is possible that this sheet is not secured to the top of the cabinet properly, and was found to sag around the middle of the cabinet. This could lead to the sheet interfering with secondary disconnects. Removing the glastic sheet does not require any tools, but you need to exercise the caution while removing the glastic sheet to avoid contact with compartment mounted secondary disconnects. After removing the glastic sheet, discard it.

AKD-8 AKR-30S —Modify Bracket



- It must be ensured that the supply power to the compartment is turned off/ compartment is de-energized for all the incoming and outgoing circuits of the LVS prior to any work being conducted on it.
 - During the installation and related work on the equipment, it must be ensured that the operator is using the prescribed PPE for the specified tasks.
- Ensure only qualified personnel install, operate, service, and maintain all electrical equipment.

Figure 12. Modify Bracket



Steps for removing the bracket pin:

1. Remove the left bracket assembly (75C149309G061) from the compartment (*Figure 12*). The assembly is bolted to the side sheet. Remove (4) ¼-20 thread forming screws using a socket wrench and 3/8" hex socket.
2. Remove the pin from the bracket (75A106208P204). The pin is riveted from the inside and has to be drilled from the same side. Removing the bracket is necessary.
3. Note that the assembly must be done by a trained service technician only.
4. Apply corrosion resistance treatment to the exposed metal after removing the pin.
5. Reassemble the bracket assembly and scrap or discard the pin. Torque ¼-20 thread forming screws to 85 in-lb.

Install AKD-8 (800-2000A) Retrofill Breaker



- It must be ensured that the supply power to the compartment is turned off/ compartment is de-energized for all the incoming and outgoing circuits of the LVS prior to any work being conducted on it.
 - During the installation and related work on the equipment, it must be ensured that the operator is using the prescribed PPE for the specified tasks.
-
- Ensure only qualified personnel install, operate, service, and maintain all electrical equipment.

After the existing breaker is removed and the compartment modified, the pre-wired Retrofill breaker can now be installed in the switchgear or switchboard.

1. Verify that the breaker is in the disconnected and OPEN position before mounting it on rails.
2. Pull out the cubicle rails, horizontal to the ground.
3. The rails can now support and secure the Retrofill breaker in the switchgear.
4. For AKR-30S Retrofill Breaker : Insert eyebolts in the 10 mm eye bolt weld nuts as shown in *Figure 13*. Use a chain and hook to lift the breaker from above.
5. For AKR30/30H/30L/50/50H/-T50H Breakers same arrangement as above can be used to lift breaker
OR

Use GE part number **0247B8961G002** lifting bar and suitable hoist to lift from above as shown in *Figure 14*.

Figure 13. AKD-8—Location of Eyebolts

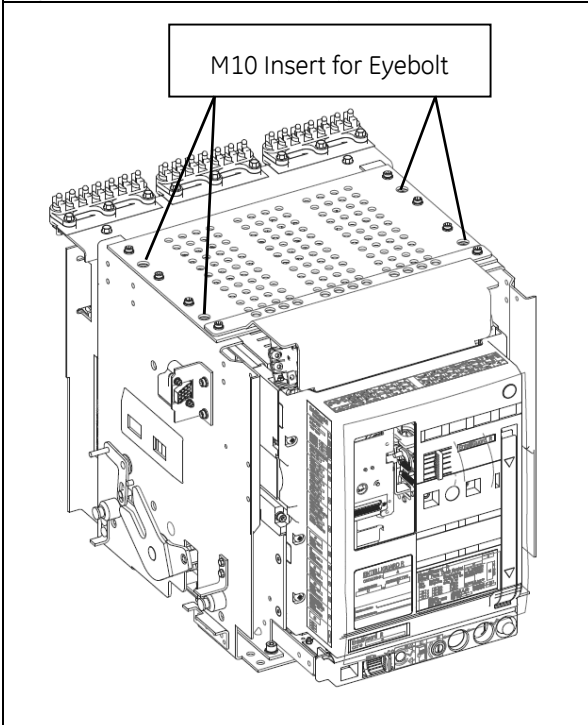

Figure 14. AKD-8—Using GE Lifting bar and hoist



6. Make sure that the lifting bar is secured and locked in place on the breaker. Check that the breaker is free from obstruction inside the compartment.
7. When the breaker is lined up with the compartment, raise the breaker only slightly higher than the compartment Rails.
8. Keep the breaker steady. Continue to guide the breaker, while checking both sides and underneath, so that both sets of pins can be lowered and lined up easily with the rail slots.
9. Once the breaker is resting in the rail Slots, unhook the lifting hooks from the circuit breaker. Move the hoisting apparatus out of the way.
10. Push the breaker in until the compartment racking pins engage with the breaker racking cams.

11. Remove the racking tool (*Figure 15*) from the storage location on the breaker front panel and extend the torque bar from inside the handle.



12. Use a blade-type screwdriver in the slot or rack out lock of the breaker (*Figure 16*), and turn it clockwise to the right so that the racking handle shutter opens

Figure 16. AKD-8—Racking Tool and Screwdriver Inserted

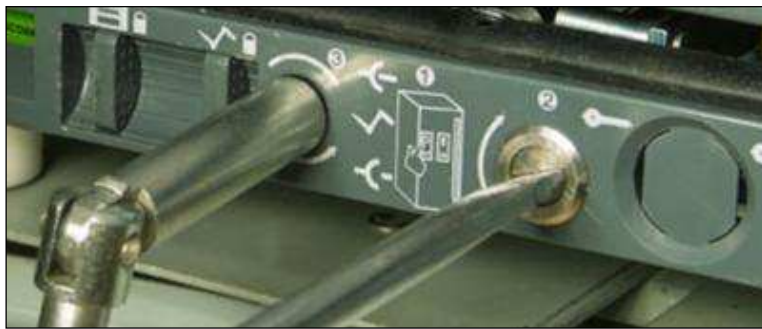

Inserting the racking handle:

- First, insert a blade screwdriver in the right-hand slot and rotate it to the right.
- Then, while holding the screwdriver torqued to the right, insert the racking tool in the left slot until it engages with the mechanism inside.
- After the racking tool engages, remove the screwdriver.

13. While turning the screwdriver to the right with the shutter open, insert the racking tool in the handle insertion hole so that it engages with the racking mechanism, and remove the screwdriver (*Figure 16*).
14. With the racking tool inserted crank clockwise so that the Retrofill starts to move in, slowly sliding forward into the compartment. Rotating clockwise racks the circuit breaker all the way into the enclosure.
15. Rotating clockwise ~37 turns racks the circuit breaker all the way into the compartment.
16. As the breaker approaches the TEST position, check the alignment of the fixed and moving parts of the secondary disconnect contacts. If a spring-charging motor or under voltage release is installed, these may operate when approaching the TEST position.
17. Continue rotating the racking handle clockwise until the position indicator first shows TEST, then CONNECTED.
18. When approaching the CONNECTED position, more torque for turning the racking handle is normal as the primary finger clusters engage with the AKD-8 or OEM Substructure primary bus stabs.

19. At the end of 37 rotations, the breaker is in its maximum travel position. At this point, the primary disconnect fingers have completely engaged with the primary bus stabs.
20. Remove and store the racking handle in its storage location.

AKD-8—Racked-In

The photo below shows one example of a racked-in AKD-8 Retrofill (*Figure 17*).



Install AKD-8 & substructure type 3200, 4000 & 5000A Retrofill Breaker.

To remove the exiting breaker follow instructions provide with the legacy breaker and or switchgear/ switchboard. Note that one must remove the two 3/8-16 bolts holding the breaker down on the drawout tray assembly. (found at the front of the tray). Notice how the breaker is located at the rear by two 3/8" diameter pins passing thru the old breaker frame. Notice how the rejection plates underneath the legacy breaker align with rejection pins on the drawout tray assembly. Verify the correct breaker is being used. Compare the rejection plate arrangement on the new breaker to those on the old breaker.

After the old breaker is removed and the compartment updated with any added features, and secondary wiring checked, the breaker can be installed in the GE AKD-8 Switchgear, GE Switchboard or OEM Equipment.

1. Verify that the new breaker is in the DISCONNECT and OPEN position.
2. For the AKR-75/100/125 Retrofill Breaker.
 - A. It is best to use GE Part number **0247B8961G001** for 3200-4000A and **0247B8961G003** for 5000A Lifting Bar and a suitable hoist to lift from above as shown in Figure 18A. (This lifting bar has been tested to 200% of its 700 lb rating.)
 - B. Alternate method, use a lifting chain and hooks rated at least 1400 lbs to lift the breaker from above as shown in Figure 18B. (chains must not be at an angle less than 45 degrees from the horizontal plane.) Installation in upper compartments may not be possible with limited overhead space or using the GE switchgear hoist without the lifting bar noted above.



3. Make sure that the lifting bar or generic chain-hooks are secured and locked in place. ***Dropping a breaker can result in injury or death.***
4. Line up the breaker in front of the compartment where it will be installed; then raise it slightly above the height of the drawout Tray assembly.
5. Pull out the drawout tray assembly beneath the breaker.
6. Align the breaker ***in front of*** the 5/8" diameter conical topped pins at the rear of the tray and align the smaller 3/8" diameter pins ***to locate thru the holes in the breaker frame.***
7. Lower the breaker down on the tray. It should sit flat if the rejection pins pass thru the rejection plates properly and the breaker was located as in step 6.
8. Install two 3/8-16 bolts thru the lower breaker frame at the front corners and into the drawout tray assembly. Torque both to 25 lb-ft.

9. Remove the lifting bar and or chains.
10. Check for alignment of the optional Programmer disconnect on the left side in the compartment.
(It is fragile and will break if not properly aligned).
11. Push the breaker into the compartment slowly while observing the programmer disconnect mating and watching for the alignment of the secondary disconnects and opening of the optional shutter. A compartment interlock rod in the right front will ride over a cam and drop into position in the Disconnect position.
12. When fully installed to the DISCONNECT position, the racking cams will stop on the racking pins in the compartment and the breaker will be ready to rack in.
13. Remove the racking tool. *(Figure 15)* from the storage location on the breaker front panel and extend the torque bar from inside the handle.
14. Use a blade-type screwdriver in the slot or rack-out-lock of the breaker *(Figure 16)*, and turn it clockwise (to the right) so that the racking handle shutter opens.
15. While turning the screwdriver to the right with the shutter open, insert the racking tool in the handle insertion hole so that it engages with the racking mechanism, and remove the screwdriver *(Figure 16)*.
16. Rotating clockwise ~37 turns racks the circuit breaker all the way into the compartment.
17. As the breaker approaches the TEST position, a spring charging motor or undervoltage release if installed may operate. (~ 9 racking turns).
18. Continue rotating the racking handle clockwise until the position indicator first shows TEST; then CONNECTED.
19. When approaching the CONNECTED position, more torque for turning the racking handle is normal as the primary finger clusters engage with the primary bus stabs.
20. At the end of 37 to 37-1/2 rotations, the breaker is in its maximum travel position. At this point the primary disconnect fingers have completely engaged with the primary bus stabs.
21. Remove and store the racking handle in its storage location.

AKD-8—Racked-In

The photo below shows one example of a racked-in AKD-8 Retrofill *(Figure 19)*.



AKD-8—Install Accessories

	<p>WIRING</p> <ul style="list-style-type: none">• Before installing the breaker, the secondary disconnects must be wired to the EntelliGuard R Breaker.• Wires with wire markers are provided on the breaker. Make sure that the switchgear wiring connection points match up with the original wiring of the cubicle. This ensures that all wiring connections are properly made.• Wrong connections will cause the breaker to malfunction.
---	---

AKD-8—Secondary Disconnects, Bullets

This section deals with installing and wiring the legacy secondary disconnect assemblies onto the EntelliGuard R breaker. Installing the secondary disconnect assembly consists of doing these tasks:

- Installing the secondary disconnect assembly (bullets, shown in *Figure 20*, below)
- Wiring the secondary disconnect assembly (bullets, shown in *Figure 20*, below)

The EntelliGuard R Retrofill Breaker has these two options:

- All secondary disconnects installed
- No secondary disconnects installed

In case the application requires installing all 3 secondary disconnect blocks (actually, three sets of bullets), you would select the first option. As secondary disconnects can be pre-installed on the breaker, wiring the secondary disconnects can be done.

In case the application does not require any secondary disconnect assemblies, take the second option. Thus, no further wiring is needed.

If the application requires less than 3 secondary disconnect blocks, the customer can choose the second option, order the secondary disconnect blocks as needed, and then install the secondaries, completing the wiring for the breaker. These options are discussed in the next sections.

Figure 20. AKD-8—Seven Bullets to a Block, Three Blocks

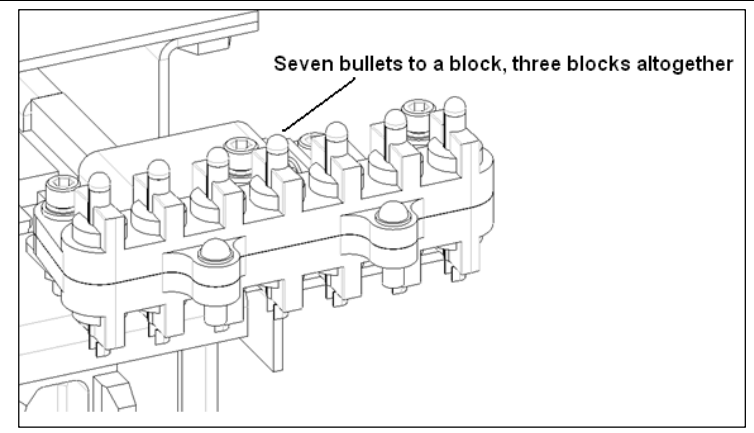
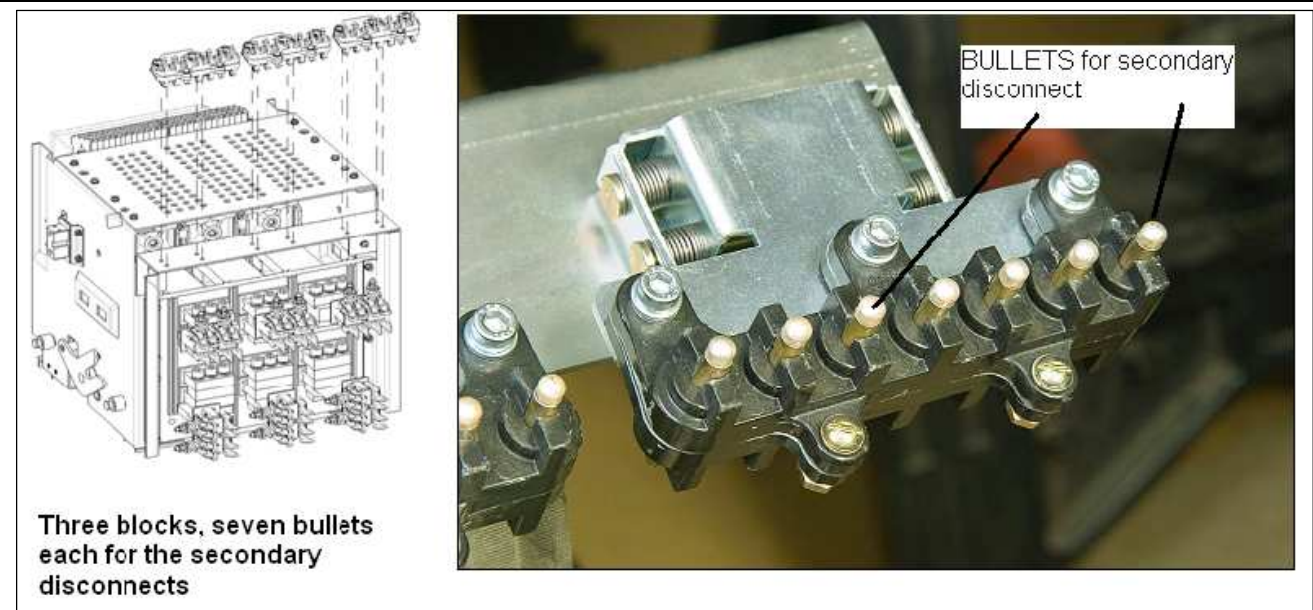

Figure 21. AKD-8—Seven Bullets to a Block, Three Blocks (Exploded View) (Model 1)



The secondary disconnect block assemblies (*Figure 21*) for the AKD8 version of the EntelliGuard Retrofill can be purchased and installed. Here are the installation instructions:

For Model 1 AKD8 Retrofill Breakers

1. Unpack the secondary disconnect block from the box. The kit comes in just one box. Each kit of secondary disconnect has 4 nuts, plain washers, and spring washers. These can be arranged on a work station for preparing to install the secondary disconnect blocks.
2. Check that the bullets, on top of the secondary disconnects, are not damaged and that they slide in to the blocks freely. The bullets are spring-loaded and return to their initial positions when they are released from being pressed down.
3. Check for electrical continuity between the bullets on one end and the wire terminations on the other. Blocks containing faulty bullets should be replaced.

4. Replace bullet blocks that are found with faulty bullets. Even with only one non-working bullet, replace the whole block of bullets.
5. Place the secondary disconnect block on top of the horizontal plate that runs across the width at the rear of the breaker.
6. Align the 4 studs at the base of the supplied block to the 4 holes on the horizontal plate. The plate contains 3 sets of 4 holes, one each for the A, B, and C blocks.
7. Slide the secondary blocks down into the plate such that the base of the secondary disconnect rests on top of the plate.
8. Secure the studs on to the Mounting plates using the hardware provided as mentioned above (*Figure 21*) and shown below (*Figure 22*). The Screws must be tightened by hand.
9. Check that the wire markers are clearly visible and not damaged so that wiring connections are done correctly and easily (*Figure 23* and *Figure 24*).

For Model 2 AKD8 Retrofill Breakers

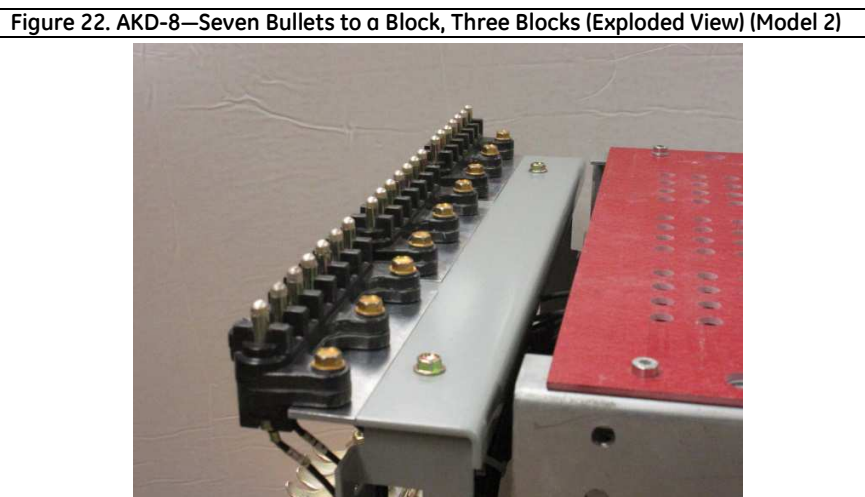

1. If the EntelliGuard R Retrofill breaker order included (3) 7 point secondary disconnect blocks see step 2 otherwise skip past the wiring instructions.
2. Check that bullets, on top of the secondary disconnects, are not damaged and that they slide in to the blocks freely. The bullets are spring-loaded and return to their initial positions when they are released from being pressed down.
3. Check for electrical continuity between the bullets on one end and the wire terminations on the other. Blocks containing faulty bullets should be replaced.
4. Place the secondary disconnect block on top of the horizontal plate at the rear of the Retrofill EntelliGuard ACB, which runs across the width of the Retrofill EntelliGuard ACB.
5. Align the three holes on the face of the supplied secondary block to the three holes on the plate and secure the block to the plates using the ¼-20 thread forming screws. The screw tightening torque should be ~40 in-lbs. (Be careful not to break the plastic).

For AKD8 (AKR75/100/125) Retrofill Breakers

Figure 22A. AKD-8—Seven Bullets to a Block, Three Blocks

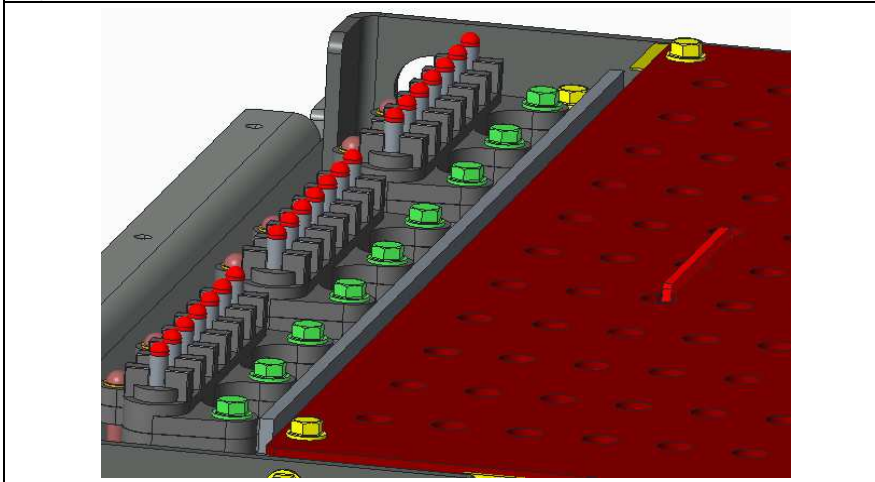

1. If the EntelliGuard R Retrofill breaker order included (3) 7 point secondary disconnect blocks see step 2 otherwise skip past the wiring instructions.
2. Check that bullets, on top of the secondary disconnects, are not damaged and that they slide in to the blocks freely. The bullets are spring-loaded and return to their initial positions when they are released from being pressed down.
3. Check for electrical continuity between the bullets on one end and the wire terminations on the other. Blocks containing faulty bullets should be replaced.
4. Place the secondary disconnect block on top of the horizontal L-Bracket at the rear of the Retrofill EntelliGuard ACB, which runs across the width of the Retrofill Breaker.
5. Align the three holes on the face of the supplied secondary block to the three holes on the L-Bracket and secure the block to the Bracket using $\frac{1}{4}$ -20 thread forming screws. The screw tightening torque should be ~40 in-lbs. **(Be careful not to over tighten or it may break the plastic).**

NOTICE

WIRING

- Do not pinch/damage the wires while installing the secondary disconnect blocks.

Figure 23. AKD-8—Seven Bullets to a Block, Three Blocks to a Retrofill (Photo View)

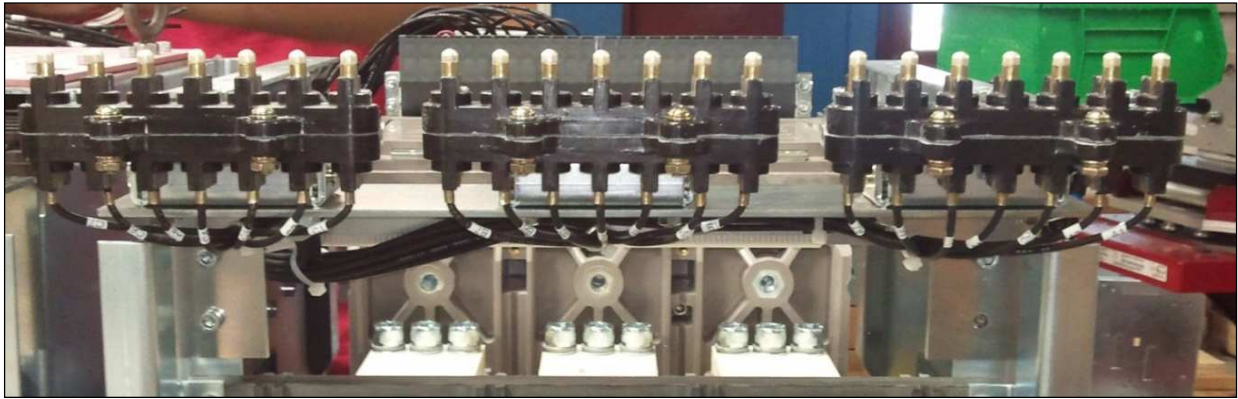

Figure 24. AKD-8—Landed Wiring (Photo View)



Wire Secondary Disconnect Assembly—AKR30/30H/50/50H/30L/30S,T-50H

As mentioned above, the secondary disconnect blocks are available with all blocks installed. In this case, the wires on the blocks will be routed through one side of the breaker and on the front. The wires on the front are left loose for ease of landing the wires in the breaker secondary Terminal Blocks.

If the secondary disconnect blocks are installed at the customer site, the wires will not have been routed. The wires should not be routed from the outside of the metal structure as it might interfere with the motion of the kit when racking into the compartment. Ensure that the wires are securely fixed on the inside metal frame of the cassette using sticky pads and tie-wraps or holes available in side frames.

Verify that the wire routing is not exerting pressure on bullets because this can bend the connection points and effect biasing and contact pressure. By using tie-wraps and stickpads, wire routing can eliminate sagging of the wire harness and pressure on secondary bullets.

Once the above mentioned steps are completed, begin landing the wires to the points on the secondaries, based on the typical wiring diagrams found in *Figure 25* and *Figure 26*.

Figure 25. AKD-8—Secondary Disconnects Wiring Diagram (Example for AKR30/30H/50/50H/T-50H,30L/75/100/125)

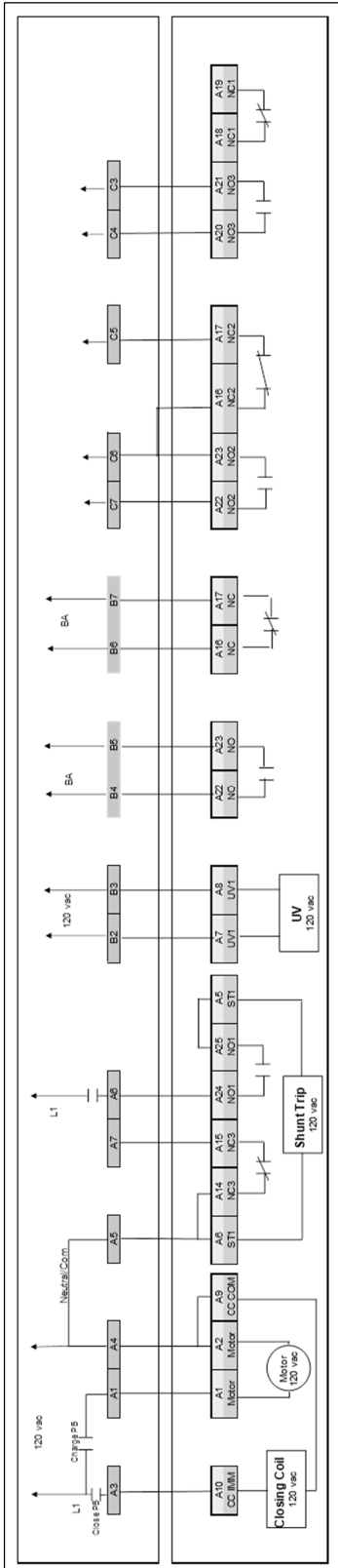

For Shunt trip > 125Vdc only: Use 2 NO contacts in series with coil.
 For S/T #1 use 2nd NO contact at terminals B25-B26. (Jumper A21 to B25 and B26 to A5.)
 For S/T #2 use 2nd NO contact at terminals B17 -B18. (Jumper B20 to B17 and B18 to A12).

Figure 26. AKD-8—Secondary Disconnects Wiring Diagram (Example for AKR30S)

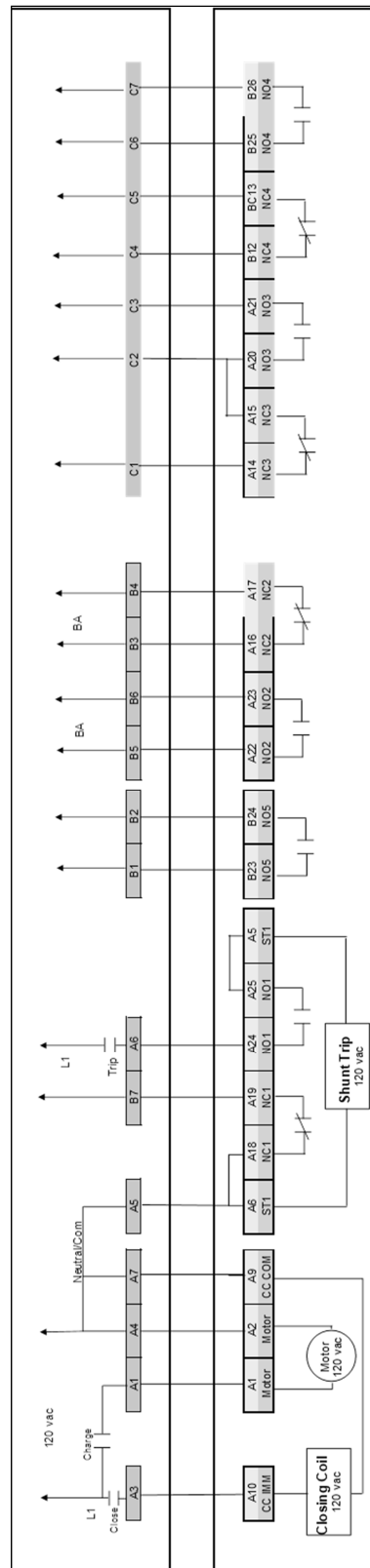

For Shunt trip > 125Vdc only: Use 2 NO contacts in series with coil.
 For S/T #1 use 2nd NO contact at terminals B25-B26. (Jumper A21 to B25 and B26 to A5.)
 For S/T #2 use 2nd NO contact at terminals B17 -B18. (Jumper B20 to B17 and B18 to A12).

- Tools needed: Philips Head screw driver, wire strippers, wire cutters.

AKD-8—Programmer Disconnects

	<p>WIRING</p> <ul style="list-style-type: none"> • Before installing the breaker, the secondary disconnects must be wired to the breaker. • Wires with wire markers are provided on the breaker. Make sure that the switchgear wiring connection points match up with the original wiring of the cubicle. This ensures that all wiring connections are properly made. • Wrong connections will cause the breaker to malfunction.
---	--

The programmer disconnect consists of 2 assemblies, one mounted on the breaker side and the other mounted on the cabinet. The breaker side assembly consists of the mounting bracket and plug assembly. The compartment side assembly consists of the plug assembly mounted on a spring-loaded assembly that receives the breaker.

	<p>WIRING</p> <ul style="list-style-type: none"> • Note: Look for the wiring connection scheme on the existing or old terminal block and use the same references or wiring information while re-wiring the new terminal block.
---	---

Procedures

1. Identify the existing programmer disconnect assemblies in the compartment.

The existing programmer disconnect plugs used in AKD-8 generation of the AKR breakers are provided on the left side for the AKR30/30H/50/50H/30L/T-50H/75/100/125 and on the Right side for the AKR30S retrofits.

Programmer disconnects are provided with legacy AKR breakers in AKD-8 LVS. The breakers were equipped with the following pin configurations, depending on the application:

- 9-pin configuration (Manual plug resulting from a trip unit conversion kit)
- 12-pin configuration (Dash 1 breakers, 12 pin Tyco type plug ~ 1988-2015)
- 24-pin configuration (Original MicroVersa Trip disconnect –AMP Rectangular plug.

2. Identify the type of programmer disconnect assemblies to be installed on the Retrofill breaker.

The programmer disconnect assembly to be assembled depends upon the type of legacy breaker that is being replaced. These are as follows:

- AKR30/30H/50/50H/T50H/30/75/100/125L—In these, the programmer disconnect is mounted on the left side wall of the Retrofill breaker.
- AKR30S—In these, the programmer disconnect is mounted on the right side wall of the Retrofill breaker.

Programmer disconnect assemblies are available in two configurations, namely:

- 12-pin configuration—If the legacy LVS has a 12-pin programmer disconnect in use, the same can be used with the Retrofill breaker. In this case, only the breaker side programmer disconnect assembly on the breaker needs to be installed. The numbers for the programmer disconnects are mentioned below.

12-Pin Programmer Disconnect Breaker Side		
P/N 10105385G1	PROG.DIS.ASSY, AKD8	AKR30H/50H/T50H AKD8
P/N 10105651G1	PROG. DIS. ASSY	AKR30S
P/N 10105385G2	PROG. DIS. ASSY	AKR75/100/125
19-Pin Programmer Disconnect Breaker Side		
P/N 10108733G1	PROG.DIS.ASSY, AKD8	AKR30H/50H/T50H AKD8
P/N 10108732G1	PROG.DIS.ASSY, AKR30S	AKR30S
P/N 10108733G2	PROG.DIS.ASSY, AKR75/100/125	AKR75/100/125

- 19-pin configuration—If the legacy LVS doesn't have a 12-pin programmer disconnect configuration, and the customer chooses to install a programmer disconnect, then the 19-pin programmer disconnect assembly needs to be installed in the compartment and the breaker.

19-Pin Programmer Disconnect Breaker Side		
10108733G1	PROG.DIS.ASSY, AKD8	AKR30H/50H/T50H AKD8
10108732G1	PROG.DIS.ASSY, AKR30S	AKR30S
10108733G2	PROG.DIS.ASSY, AKR75/100/125	AKR75/100/125
19-Pin Programmer Disconnect Compartment Side		
10108801G1	PROGRAMMER DISC ASSY	AKR30H/50H/T50H AKD8
10109176G1	PROGRAMMER DISC ASSY	AKR30S
10108801G2	PROG.DIS.ASSY, AKR75/100/125	AKR75/100/125

3. If applicable, remove the existing compartment side programmer disconnect assembly.

The programmer disconnect assembly must be removed, if:

- A 9-pin manual programmer disconnect assembly is installed in the cabinet as a result of conversion kit.
 - A 24-pin programmer disconnect assembly is installed in the cabinet original MicroVersaTrip ~1979-1984.
 - Customer chooses to replace a 12-pin configuration with a 19-pin configuration to Add RELT.
4. Before uninstalling the existing programmer disconnect assembly, verify that the wiring details match the wiring numbers. Any changes or deviations need to be noted for use while installing the new programmer disconnect.
5. Check that the compartment is de-energized and is safe to work in; and that the legacy breaker has been removed from the cabinet.

6. Disconnect the wires connecting the terminal block to the compartment programmer disconnect assembly. See *Figure 27*.
7. If the customer has chosen to install a 19-pin programmer disconnect assembly, replacing a 12-pin programmer disconnect assembly, the terminal block mounted on the compartment needs to be removed as well. This can be achieved by unfastening the two screws securing the terminal block with the side wall of the compartment.
8. Unfasten the four bolts included that hold the programmer disconnect assembly on the wall of the compartment to remove the compartment-side programmer disconnect assembly.

Figure 27. AKD-8—Loosen Hardware for the Programmer Disconnect Assembly

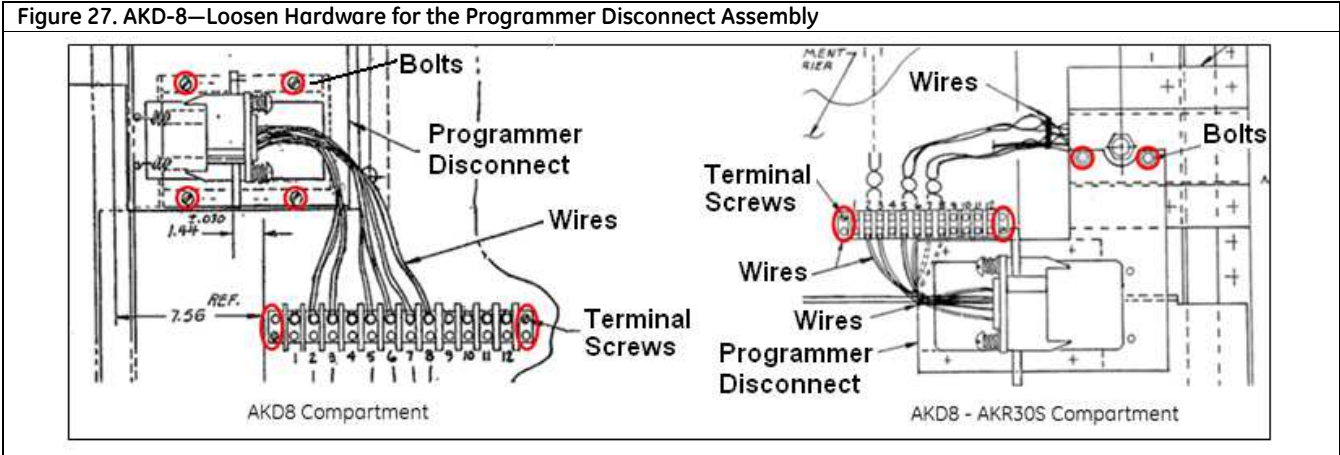

9. Install applicable programmer disconnect assembly on compartment and breaker.

- Wiring and completing task:

Install 19-pin programmer disconnect assembly on compartment and breaker:

1. Unpack the 19-pin programmer disconnect assembly from the box. Each box of the programmer disconnect assemblies has a 20-pin terminal block supplied.
2. Check that the secondary disconnect plug assembly is not damaged and the wiring is intact.
3. Check that the programmer disconnect block is moving freely within the assembly and retracts to its original position by spring-loading when it is slid back to the fully activated condition.
4. Check for electrical continuity between the contact pins on one end and the wire termination on the other. Blocks containing faulty bullets should not be used for installation.
5. Install the new terminal block on the side wall of the compartment and land the incoming wires from the compartment to the terminal block. Any additional wires from the compartment side which are required for the 19-pin programmer need to be landed on the terminal block and checked for electrical continuity.
6. Mount the programmer disconnect assembly on the side wall of the compartment where the original programmer disconnect assembly was mounted.
7. Land the wires from the programmer disconnect to the terminal block mounted earlier.
8. Using a multimeter, check for continuity between the terminal block contact points to the corresponding pins on the programmer disconnect. This should match against the wiring scheme planned for the new 19-pin programmer disconnect assembly on the compartment.

Wiring and Completion

1. Note that the breaker side programmer disconnect assemblies come pre-installed and wired from the factory, so no action needs to be done on the breaker.
2. Check that the compartment side programmer disconnect assembly wiring scheme matches that of the breaker side wiring scheme.
3. See the wiring diagram used for the programmer disconnect as shown here (Figure 28):

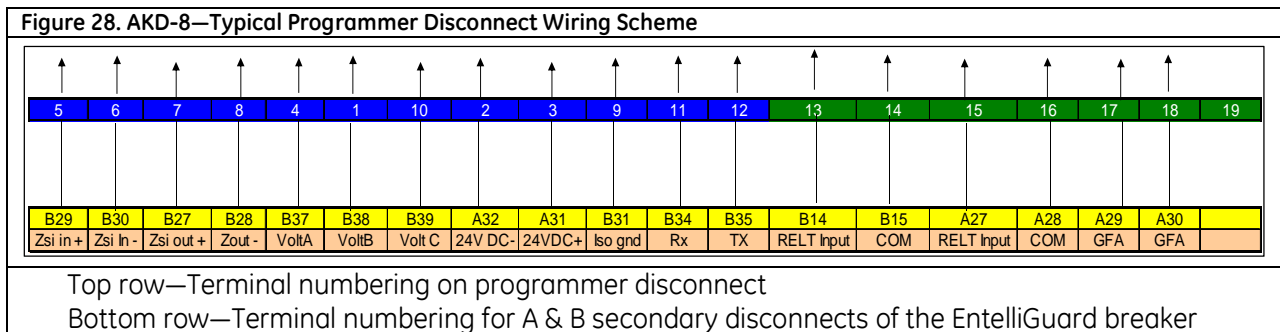

- **Tools required:** wrenches, flat head screw driver, wire stripper, wire cutter, star-type screw driver

AKD-8—Primary Disconnects (Contacts) or “Fingers”

The [Finger Clusters Accessory Manual DEH-41533](#) covers the primary disconnects or fingers.

The primary disconnects are flexible connections between the breaker line and load terminals and between the equipment line and load terminals. All primary disconnect fingers are factory-installed and are assembled on EntelliGuard R Retrofill circuit breakers. Use this instruction sheet if damaged fingers need to be replaced. It takes about 5 minutes to install a finger cluster, defined as a double pair of fingers on a breaker.

Figure 29 shows finger clusters or primary disconnects on a Retrofill circuit breaker. Figure 30 details the finger-cluster assembly.

Figure 29. Circuit Breaker Removed, Featuring Primary Disconnects “Fingers” (Contacts)

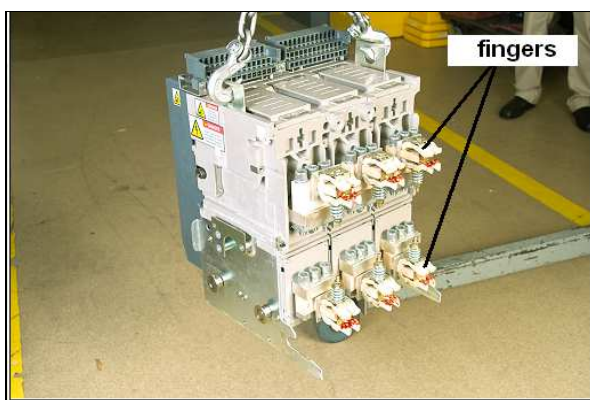
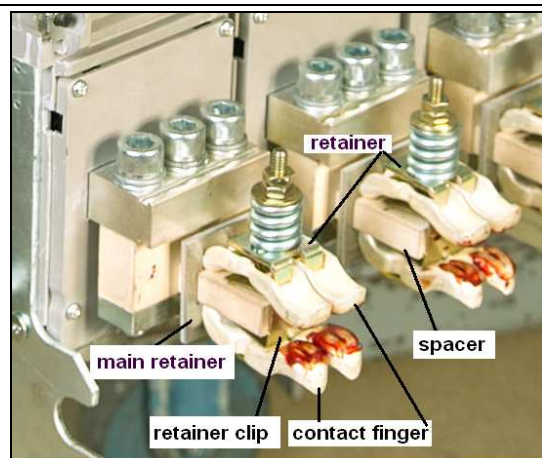
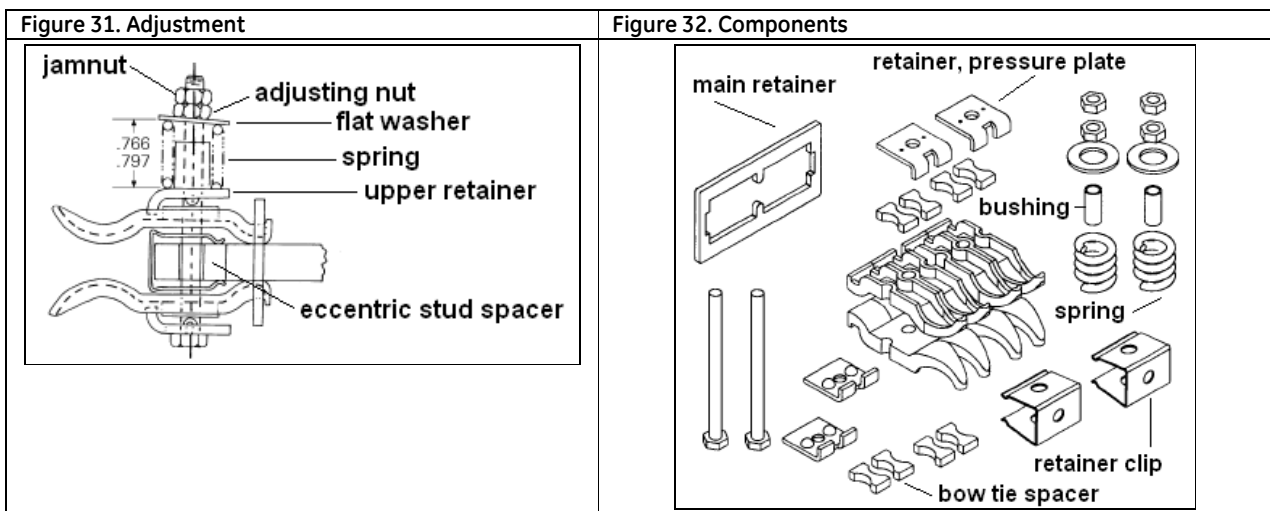

Figure 30. Circuit Breaker, Fingers (Some Details)



Remove and Replace

The primary disconnect assembly is factory-adjusted to apply a 95 ± 10 lb. force to a 1/2-inch thick copper bar, inserted between the upper and lower fingers. Set this force range, in the field, by tightening the nuts to set the spring dimension shown in *Figure 31*. Note that this dimension is measured between the top of the retainer and the underside of the washer. Also note that no bar is inserted between the fingers when setting this dimension. *Figure 32* shows the cluster components.



1. Using proper safety procedures and wearing required Personal Protective Equipment (PPE), remove breaker from compartment, and place it on a solid work surface in a well-lit location.
2. To uninstall the primary disconnects, remove the two nuts from one of the long bolts holding the primary disconnect assembly together.
3. Carefully slide out the bolt while removing the flat washer, spring, bushing, upper retainer, bow-tie spacers, lower retainer, and fingers from the bottom of the assembly.
4. Do the same for the other assembly bolt and components.
5. Slide off the retainer clips.
6. Take off the main retainer from the stud.
7. Slide the main retainer over the stud.
8. Install eccentric spacer and position spring clips on the stud.
9. Set a pair of bow-tie spacers into a pair of fingers, place a pressure plate retainer over the spacers to hold them in position, and then turn the subassembly over. Hook them into the main retainer.
10. Slide a long bolt through the hole in the retainer, between the fingers, and then through the clip and eccentric stud spacer.
11. Hold the bottom finger subassembly in place.
12. Place two fingers around the bolt from the top, hooking the fingers into the main retainer. Then place a bow-tie spacer in each finger and hold them in position with a pressure plate retainer.
13. Place a spring, bushing, and flat washer over the bolt, then secure with the two nuts.
14. Repeat Steps 7 through 13 for each set of fingers.

15. Adjust the nut to get a spacing of 0.766—0.797 inch between the top of the upper retainer and the bottom of the flat washer.
16. Tighten the jam nut to lock in the adjustment.
17. Clean finger assemblies, if necessary, with a clean, lint-free rag and isopropyl alcohol or acetone.
18. Be sure to apply a thin film of Mobilgrease 28 (D50HD38) to the contact areas which slide onto the switchgear stabs (See *Figure 33*, Step 2). This product is available in a 1-oz tube, GE Part #193A1751P1.

Figure 33 summarizes the steps for working with the primary contacts.

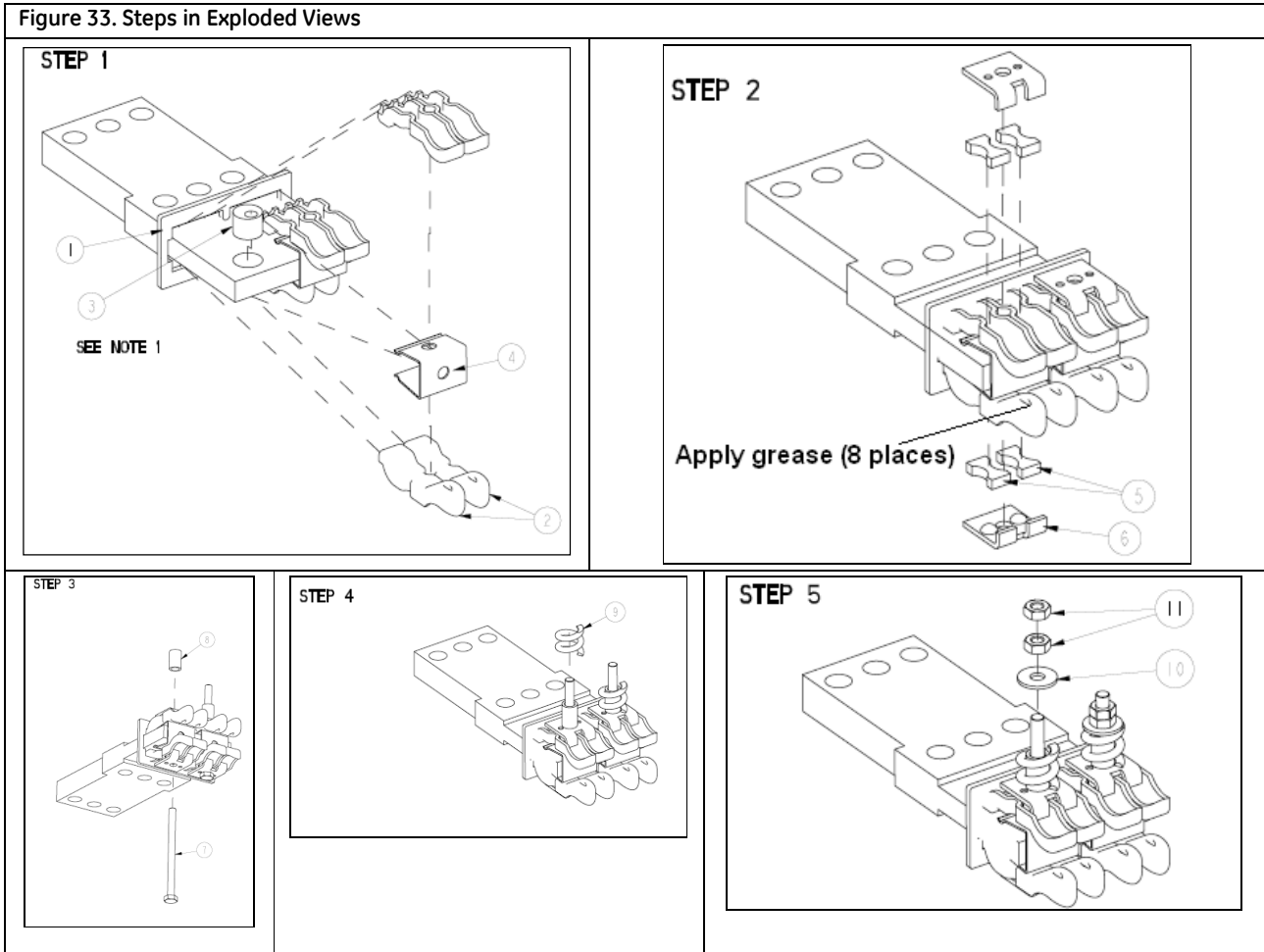

Mechanical Views

Figure 34 provides further details.

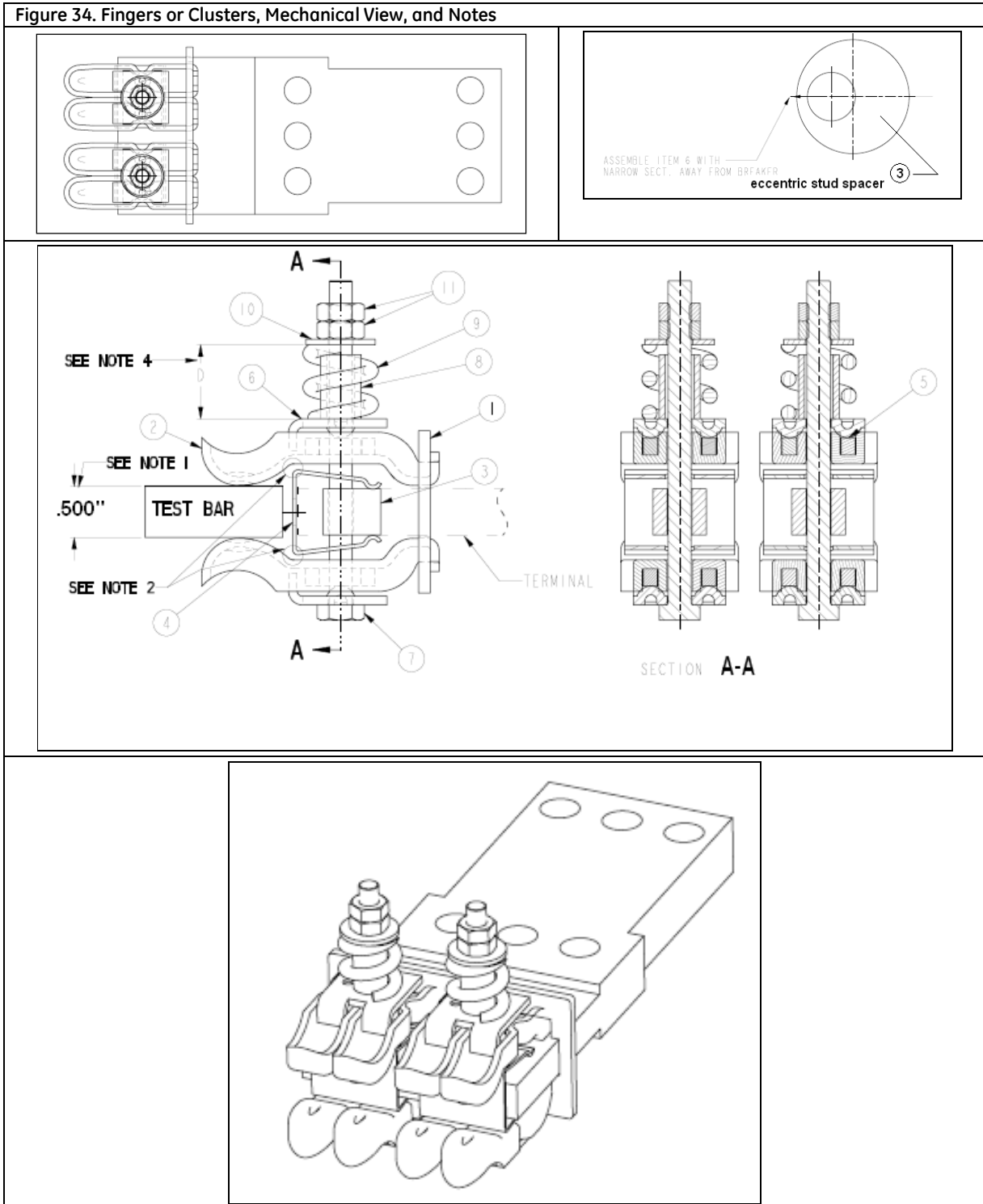

Remove and Replace- AKR-75/100/125

The primary disconnect assembly is factory-adjusted to apply a 95 ± 10 lb. force to a 1/2-inch thick copper bar, inserted between the upper and lower fingers. Set this force range, in the field, by tightening the nuts to set the spring dimension shown in *Figure 35A/35B*. Note that this dimension is measured between the top of the retainer and the underside of the washer. Also note that no bar is inserted between the fingers when setting this dimension. *Figure 36A/36B* shows the cluster components.

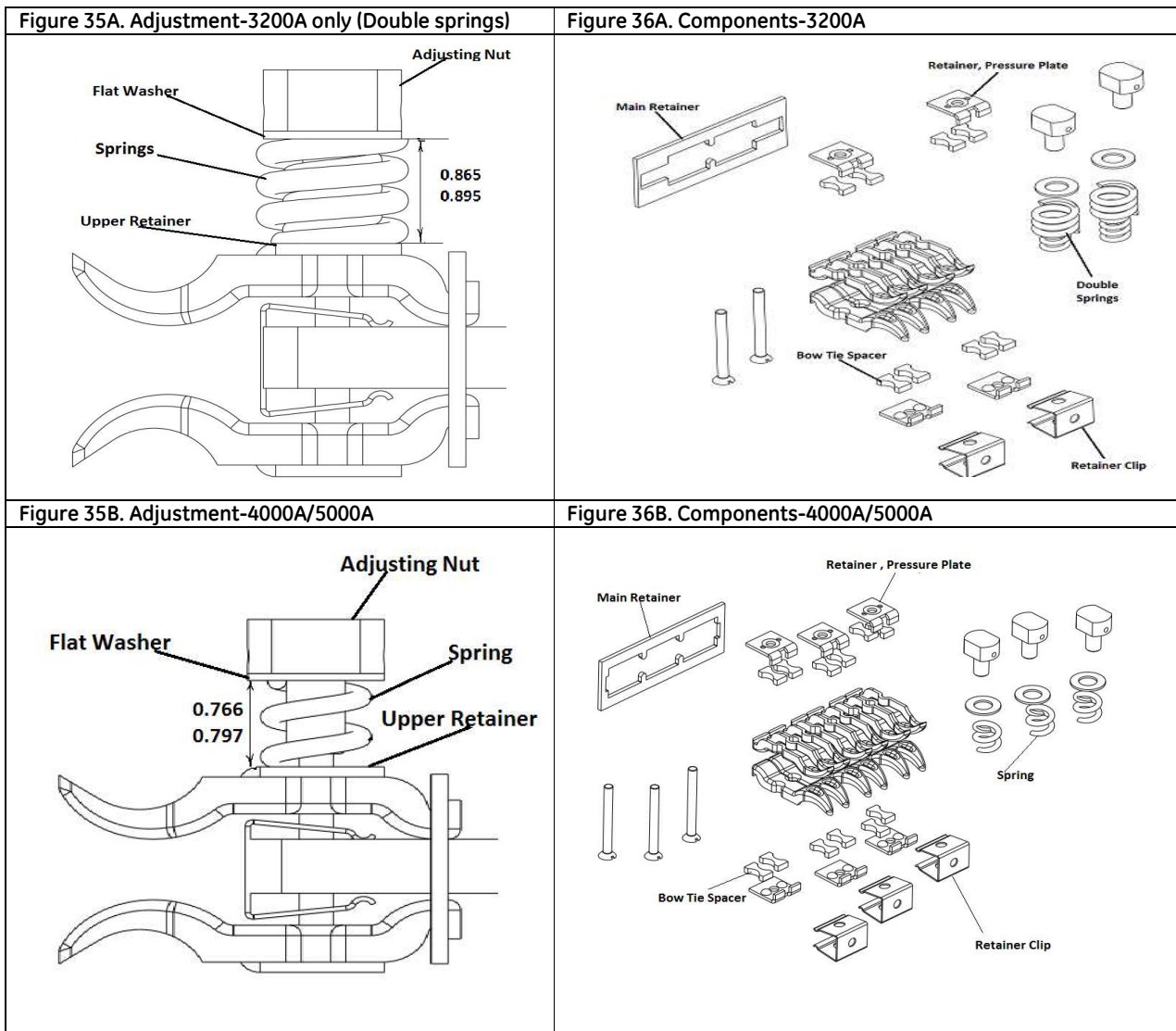

1. Using proper safety procedures and wearing required Personal Protective Equipment (PPE), remove breaker from compartment, and place it on a solid work surface in a well-lit location.
2. To uninstall the primary disconnects, remove the Adjusting nut from one of the long bolts holding the primary disconnect assembly together.
3. Carefully slide out the bolt while removing the flat washer, spring, upper retainer, bow-tie spacers, lower retainer, and fingers from the bottom of the assembly.
4. Do the same for the other assembly bolt and components.

5. Slide off the retainer clips.
6. Take off the main retainer from the stud.
7. Slide the main retainer over the stud.
8. Set a pair of bow-tie spacers into a pair of fingers, place a pressure plate retainer over the spacers to hold them in position, and then turn the subassembly over. Hook them into the main retainer.
9. Slide a long bolt through the hole in the retainer, between the finger, and then through the clip and stud spacer.
10. Hold the bottom finger subassembly in place.
11. Place two fingers around the bolt from the top, hooking the fingers into the main retainer. Then place a bow-tie spacer in each finger and hold them in position with a pressure plate retainer.
12. Place a spring, bushing, and flat washer over the bolt, then secure with the Adjusting nut.
13. Repeat Steps 7 through 13 for each set of fingers.
14. Adjust the nut to get a spacing of 0.865-0.895 inch for AKR75/75H with Double springs and 0.766—0.797 inch for AKR100/125 between the top of the upper retainer and the bottom of the flat washer.
15. Clean finger assemblies, if necessary, with a clean, lint-free rag and isopropyl alcohol or acetone.
16. Be sure to apply a thin film of Mobilgrease 28 (D50HD38) to the contact areas which slide onto the switchgear stabs (See *Figure 37/38*, Step 2). This product is available in a 1-oz tube, GE Part #193A1751P1.
17. *Figure 37 (AKR75/75H) and figure 38 (AKR100/125)* summarizes the steps for working with the primary contacts.

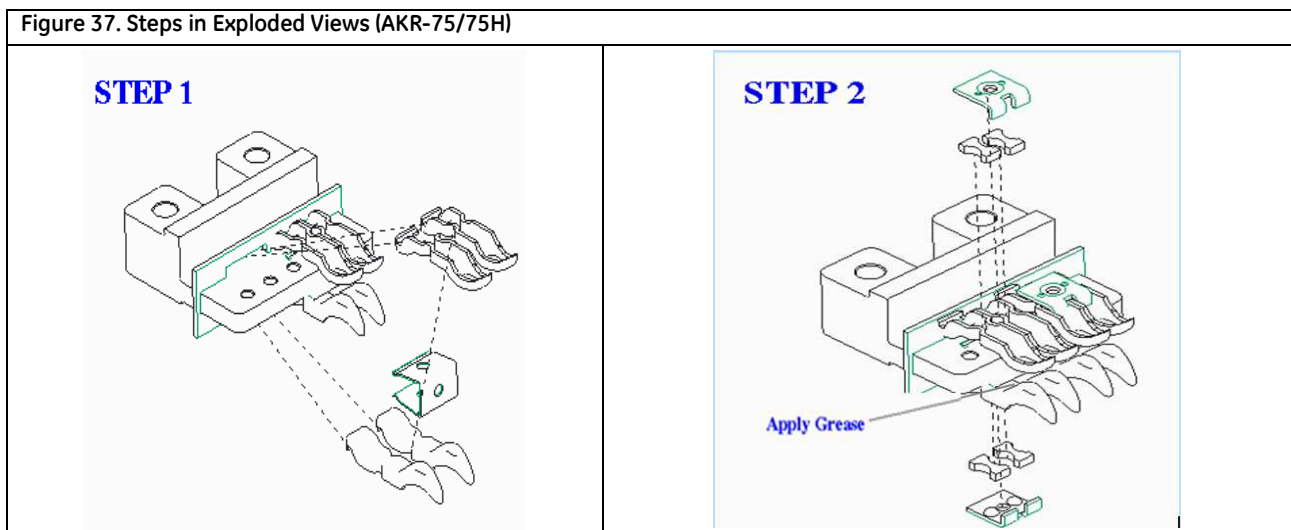

Figure 37. Steps in Exploded Views (AKR-75/75H)

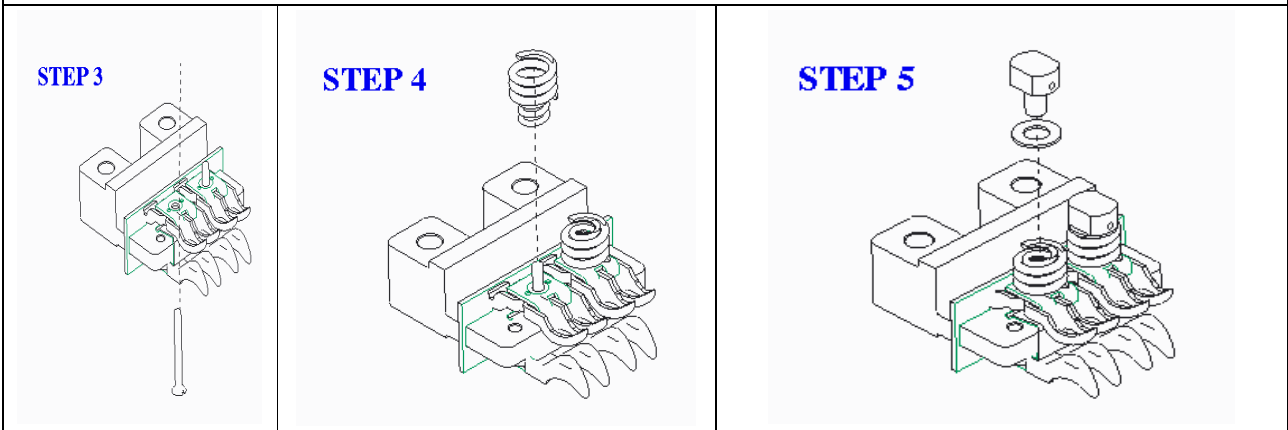
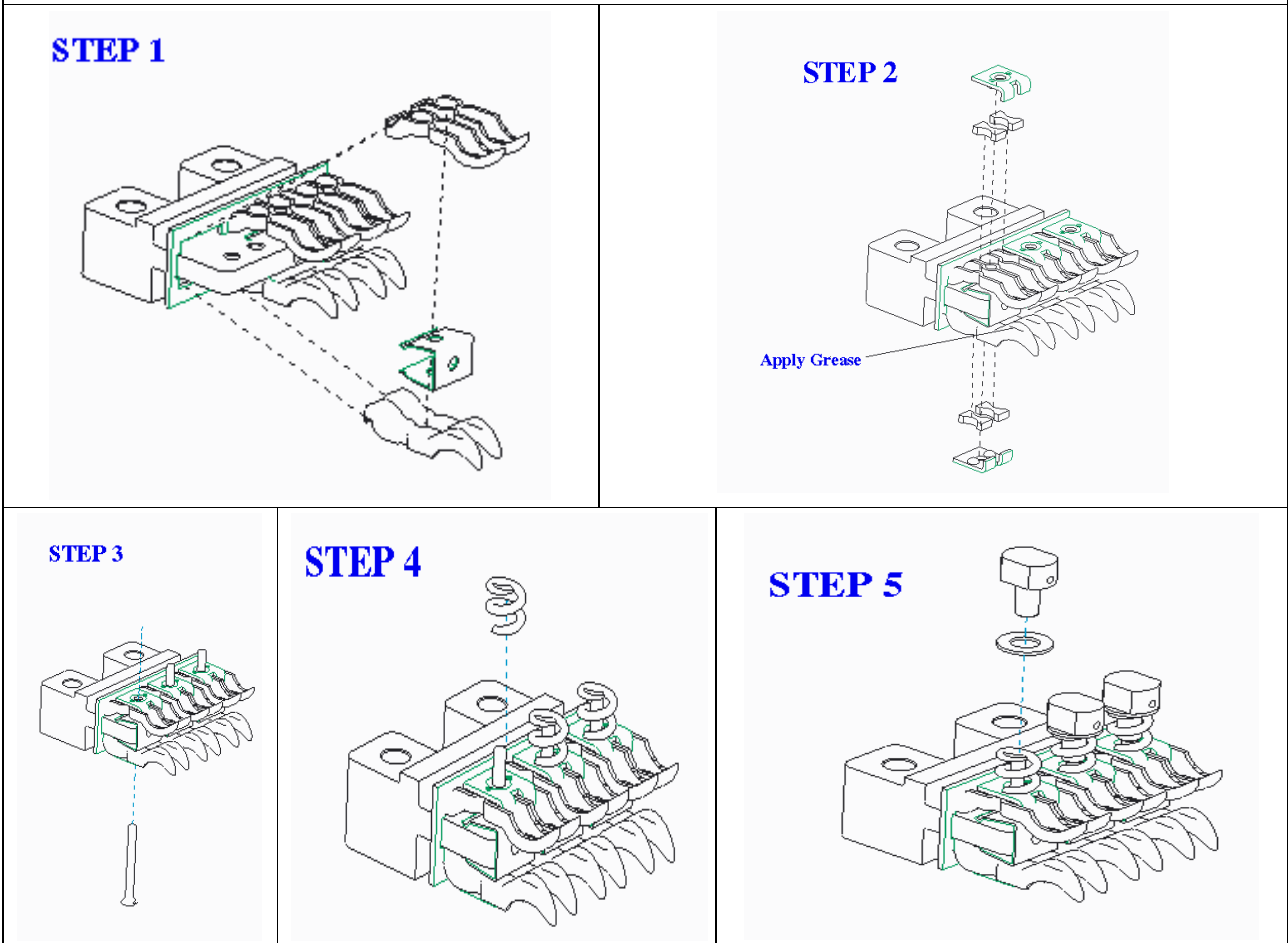
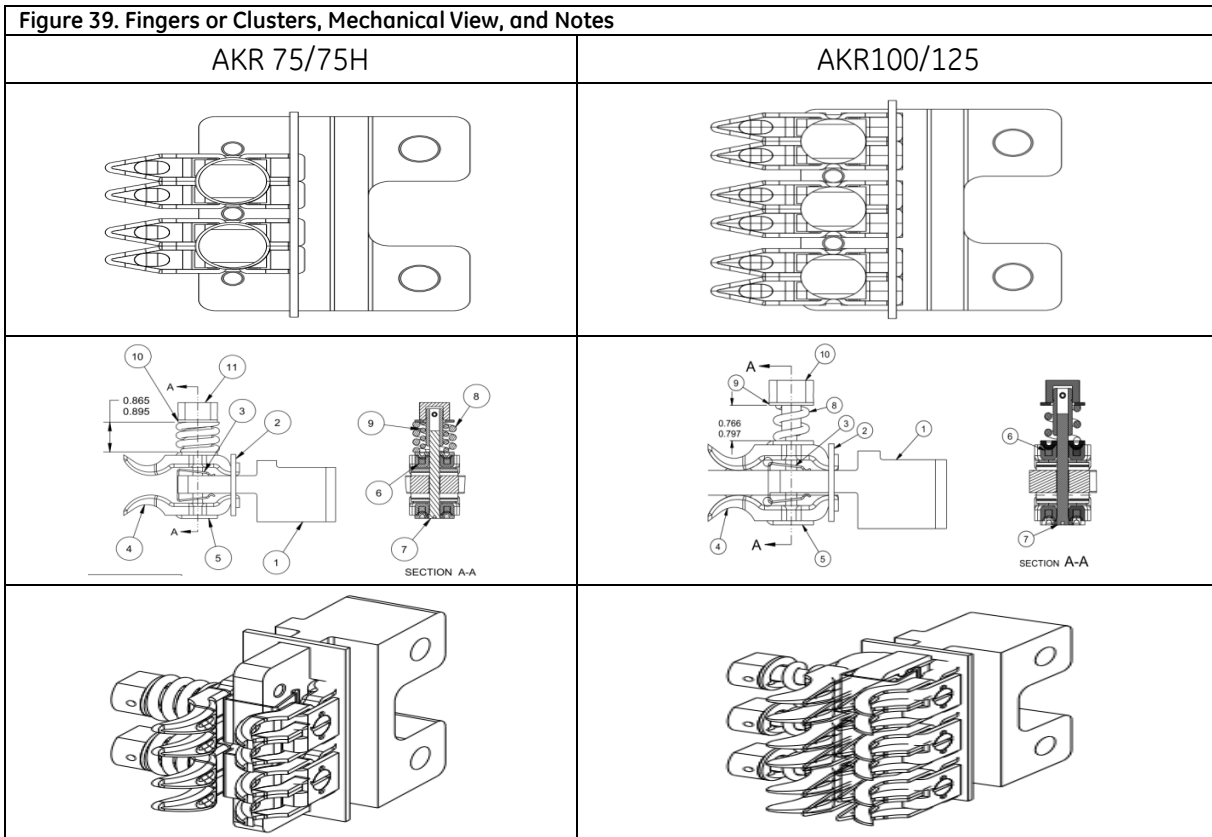

Figure 38. Steps in Exploded Views (AKR-100/125)



Mechanical Views-AKR-75/100/125

Figure 39 provides further details.



AKD-8—Position Switch Actuator

Position switch actuator comes pre-installed on all versions of Retrofill EntelliGuard ACB. Hence, no installation is required. Retrofills provide the same electrical indication scheme as the legacy breakers (*Figure 40 and Figure 41 and 41 A*).

Compartment Position Switch Assemblies	
0343L0881	AKR30S
0343L690G1	AKR30/30H/30L/50/50H
Consult Factory	AKR-75/100/125

- A customer can choose to install a position switch if it's not already installed, although this is infrequent, or the existing assembly is damaged.

Figure 40. Breaker Surfaces Activate Position Switch.

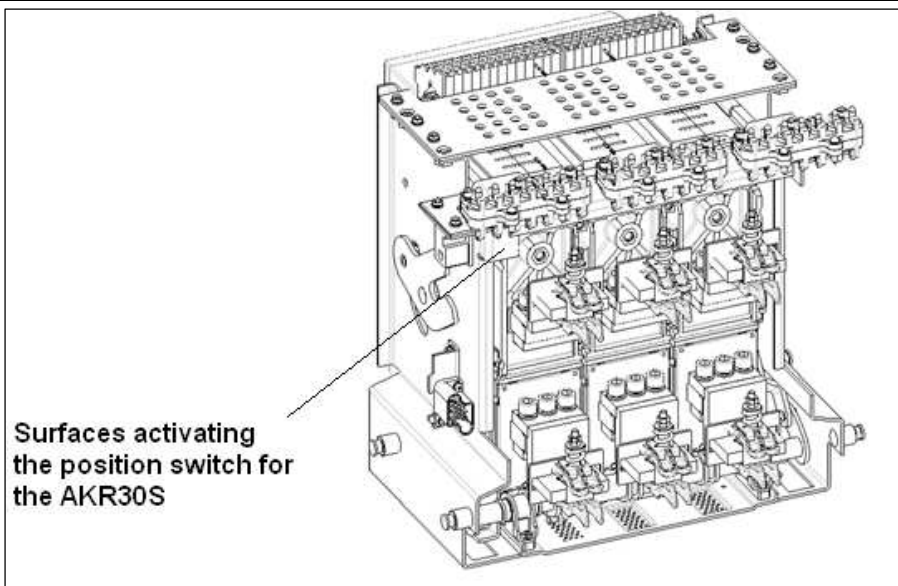
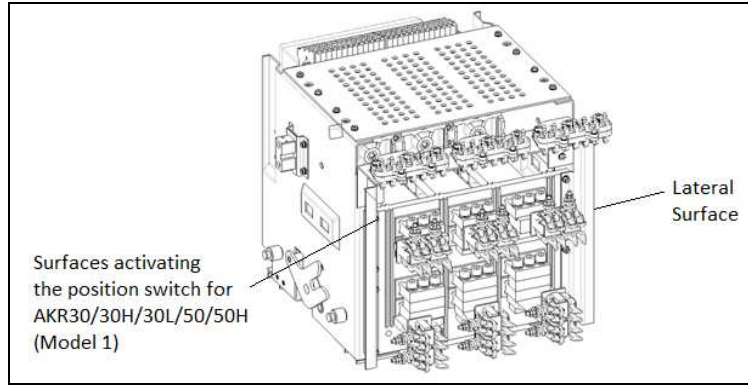

Figure 41. Breaker Surfaces Activate Position Switch. (Model 2)

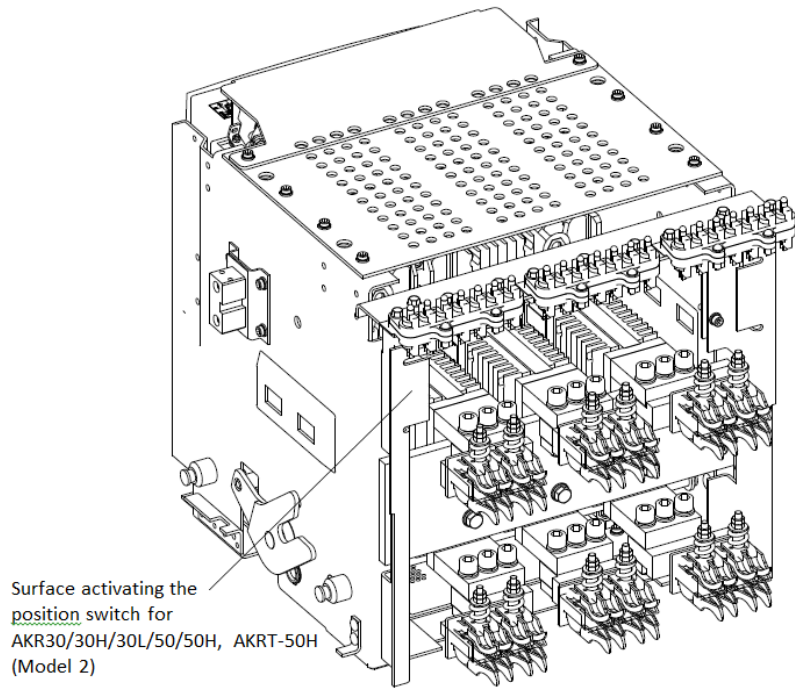
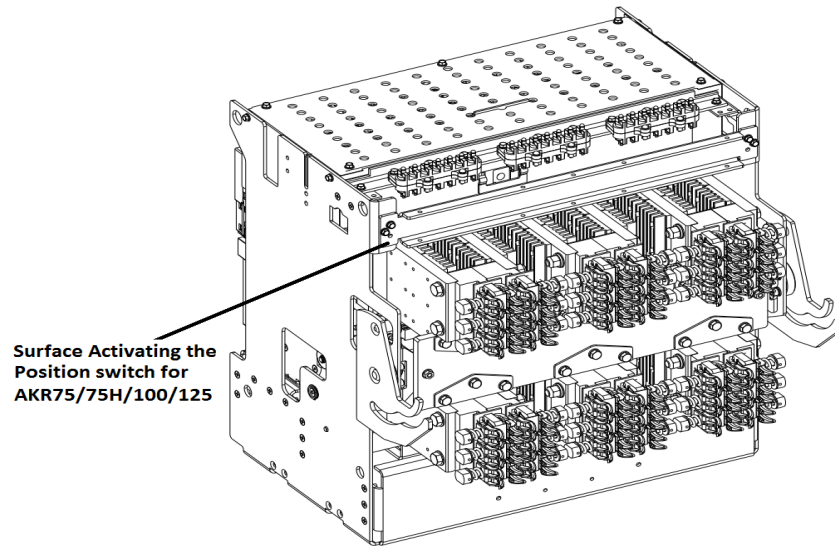

Figure 41A. Breaker Surfaces Activate Position Switch (AKR75/100/125).



AKD-8—Shutter Actuation

AKD-8 LVS comes installed with shutter assemblies for protection of the live bus bars. EntelliGuard R breaker comes pre-installed with shutter (*Figure 42* , *Figure 43* and *figure 43A*) actuators which operate the opening of the shutters. Hence, no installation is required. Retrofills provide the same mechanical indication scheme as legacy breakers.

Figure 42. AKD-8—Breaker Surfaces Activate Shutter

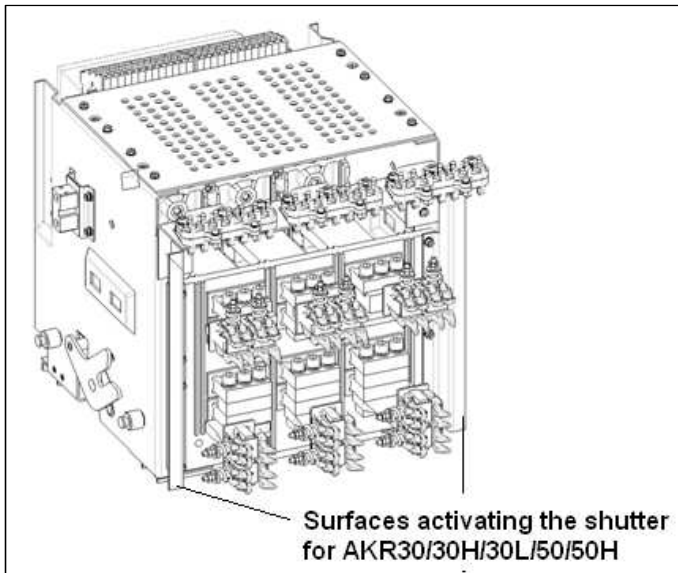

(Model 1)

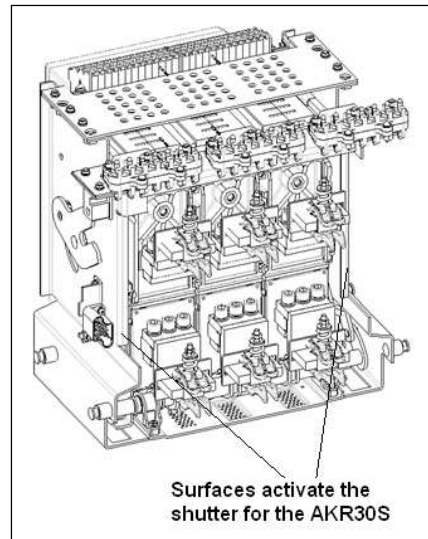
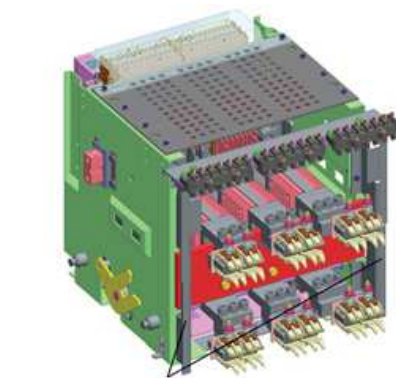
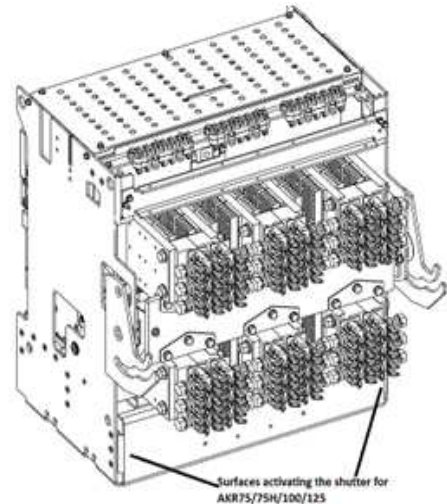

Figure 43. AKD-8—Breaker Surfaces Activate Shutter. (Model 2)



(Model 2)

Figure 43A. AKD-8—Breaker Surfaces Activate Shutter



Install Door Interlock System



- It must be ensured that the supply power to the compartment is turned off/ compartment is de-energized for all the incoming and outgoing circuits of the LVS prior to any work being conducted on it.
- During the installation and related work on the equipment, it must be ensured that the operator is using the prescribed PPE for the specified tasks.



- Ensure only qualified personnel install, operate, service, and maintain all electrical equipment.

Details regarding installation of the door interlock system are shown below in *Figure 44, 45 and 46.*

Figure 44. AKD-8—Door Interlocking Components (Model 1)

4.25	2.75	1.75	0
Disconnect state for: AKR30/30H AKR50/50H	Disconnect state for: AKR30S Retrofil GACB		Connected state for: AKR30/30H, AKR50/50H AKR30S Retrofil GACB DOOR INTERLOCK ACTIVE
<ul style="list-style-type: none"> • Racking stroke of legacy = 4.25". Racking stroke of Retrofills = 2.75". • Racking stroke of the Retrofills is equal to that of AKR30S. • Same mounting bracket used for all AKR breakers in AKD8, depending on SKU the mounting holes are decided on. • Provisions for fixing the door interlock are already present on the mounting bracket. • Door interlock system of AKR30S can be used for Retrofills. • Remove existing activator and replace with new activator shown. • For AKR30S, existing door interlock suffices. No changes needed. 			
			

Figure 45. AKD-8—Door Interlocking Components (Model 2)

Figure below shows the components that make up the AKD-8 Retrofill door interlocking assembly.

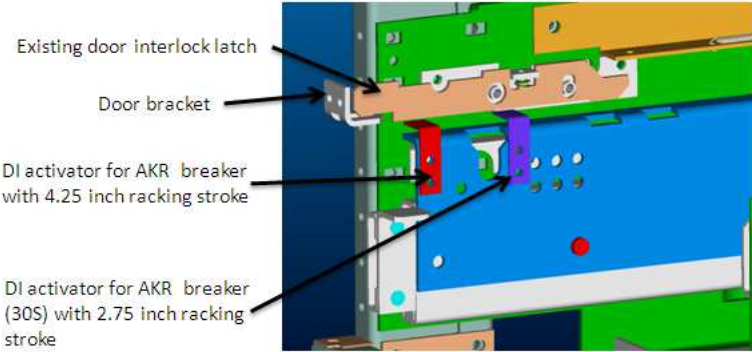
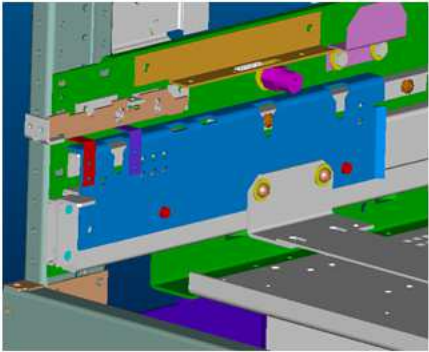
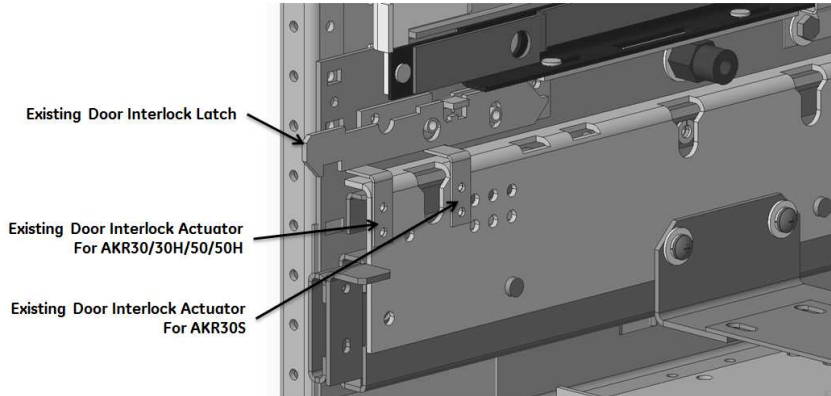

- Please remove the existing Door Interlock Actuators from the compartment for AKR-30/30H/50/50H & AKRT-50/50H
- The Retrofill breaker has a Door Interlock Actuator Bracket mounted on breaker.

Figure below shows the Door Interlock Actuator mounted on Retrofill Breaker for AKR-30/30H/50/50H & AKRT-50/50H. For AKR30S, please use compartment Door Interlock Actuator.

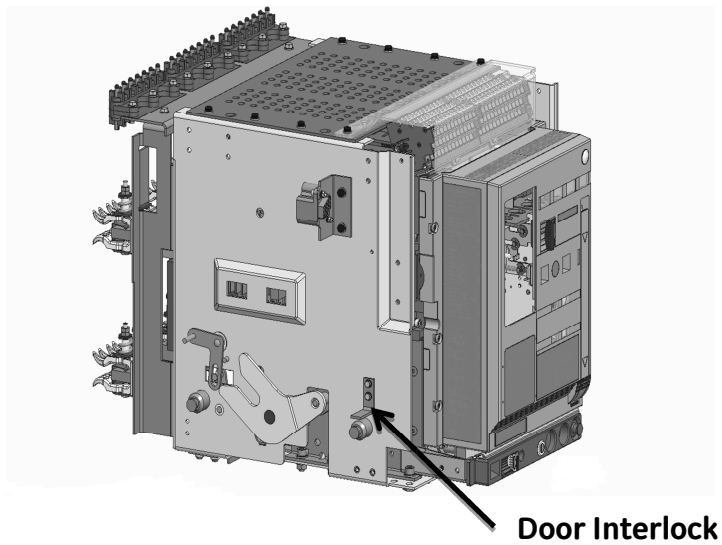
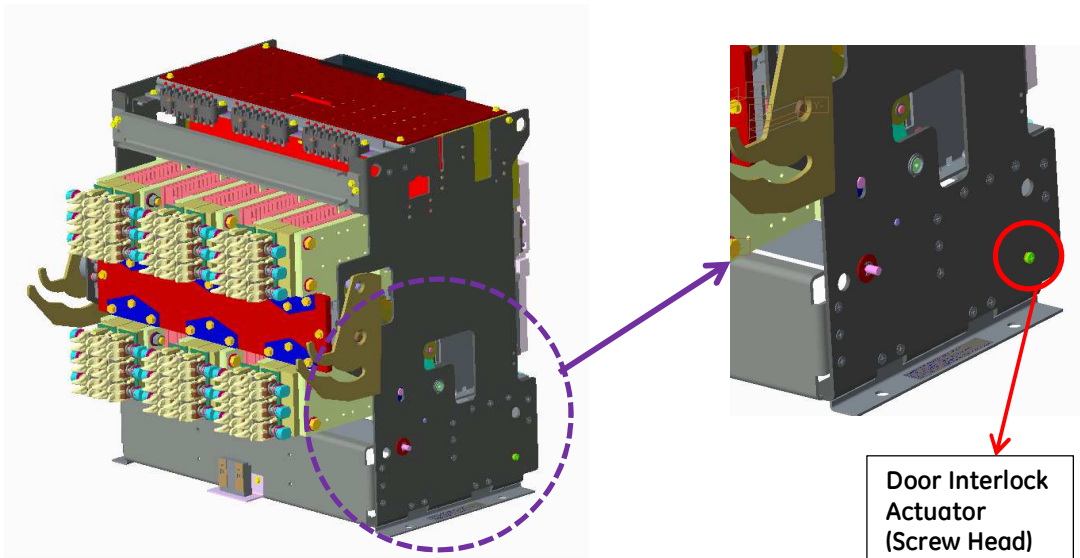

Figure 46. AKD-8 (AKR75/100/125)—Door Interlocking Components

Figure below shows the components that make up the AKD-8 Retrofill door interlocking assembly.



Figure below shows the Door Interlock Actuator mounted on Retrofill Breaker for AKR-75/100/125



AKD-8— Kirk Key Interlock

The EntelliGuard R Retrofill circuit breakers (model 2 AKR-30/50/T50 and all 3200-5000A) provided as replacements for AKR 800-5000A frame circuit breakers have a trip interlock feature which will function using the AKD-8 compartment mounted Key Interlock. A label is provided with full instructions on how to operate the Legacy Key Interlock. It is suggested to apply the label on the inside of the compartment door. Following is a brief summary of how the Key Interlock system is operated.

To activate the key interlock:

1. OPEN the breaker.
2. Rotate the screw on the lower front panel of the breaker which normally allows access to the racking screw. This will hold the breaker trip free.
3. While the screw is held rotated Clockwise, the Key Interlock slide in the switchgear is pushed inward, elevating a pin on the left side of the breaker.
4. Turn the key to the key removal position, extending the bolt and locking the breaker in the OPEN position.

Modify AKD-8—Switchgear Compartment

Cut Power to AKD-8—Switchgear



- It must be ensured that the supply power to the compartment is turned off/ compartment is de-energized for all the incoming and outgoing circuits of the LVS prior to any work being conducted on it.
- During the installation and related work on the equipment, it must be ensured that the operator is using the prescribed PPE for the specified tasks.

- Ensure only qualified personnel install, operate, service, and maintain all electrical equipment.

1. Before modifying the switchgear compartment, de-energize/switch off the breaker. If the circuit breaker is ON and the springs are charged, to turn it off, press the OPEN button on the circuit breaker fascia, and ensure that the circuit breaker contacts are open.

Rack Out AKD-8—Legacy/Existing CB

1. To rack-out legacy (old or original) breaker from compartment, refer to your legacy-breaker's manual on how to remove the existing breaker.

Check, Clean, Grease AKD-8—Compartment

1. Inspect the compartment for damage or rework.
2. Check the cabinet for suitability of the EntelliGuard R Retrofill breaker.
3. Check each breaker compartment for bolted joints in the primary disconnect bars. Where such joints exist, check the bolts for tightness.

4. Inside the compartment, check the contact areas on each primary disconnect bar or cluster of fingers for foreign matter that may have accumulated. Clean those areas if necessary with a clean, lint-free rag and isopropyl alcohol or acetone.
5. Be sure to apply a thin film of electrical grease (red, D50H387) to the contact areas for better electrical connections inside the compartment.

Install New Door

1. To remove existing compartment door(s), refer to your manual on how to remove the legacy doors.
2. To install the new door, refer to the [Retrofill Doors Assemblies for AKD-5, AKD-6, AKD-8 & AKD-10, DEH-41563](#).

Install AKD-8—Neutral Rogowski Current Transformer (CT)



- Turn off all power to switchgear. Tagout and lockout main source, up-stream or main breaker.
- Failure to comply with these instructions will result in death or serious injury from severe burns caused by arc flashing that has exceedingly high temperatures.
- Always wear personal protection equipment according to OSHA standards and appropriate to the severity of potential burns.

- Ensure only qualified personnel install, operate, service, and maintain all electrical equipment.

AKD-8—Neutral Disconnect Assembly

Figure 47 shows an exploded view of the breaker side neutral disconnect assembly for the AKD-8 AKR30/30H/50/50H/30L and AKR30S Retrofills. These are available pre-installed and wired from the factory.

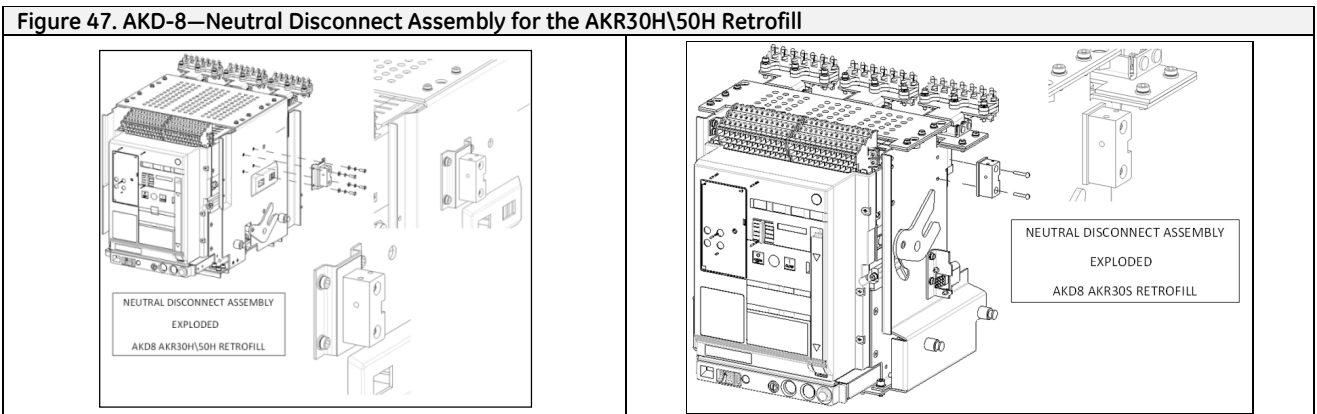

AKD-8—Neutral Disconnect Assembly, Bus Compartment

The AKD-8 EntelliGuard R Circuit Breaker uses an air-core Rogowski Current sensor to measure current level. Legacy AK and AKR breakers used iron core CTs. For the Retrofill breaker to calculate the current levels on a 4-wire circuit, the Neutral Iron Core CT in the cable compartment needs to be replaced with a Rogowski style CT.

The Rogowski CT comes mounted on copper bars matching the same hole-pattern as the existing neutral bar. Neutral CT wires from the Rogowski coil to the AKD-8 gray terminal blocks must be run as a “twisted pair”. Table 8 shows the Rogowski assembly part numbers for AKD-8 Switchgear.

AKD-8—Rogowski Assembly Part Numbers

Breaker/Switchgear	Rogowski Assembly or Neutral Bus Bar Part Number	Figure References for Assembly Drawings
AKD8 400A	10108266G1	Figure 40. Neutral Bus Rogowski ASM 10108266
AKD8 600A	10108266G2	Figure 40. Neutral Bus Rogowski ASM 10108266
AKD8 800A	10108266G3	Figure 40. Neutral Bus Rogowski ASM 10108266
AKD8 1000A	10108266G4	Figure 40. Neutral Bus Rogowski ASM 10108266
AKD8 1200A	10108266G5	Figure 40. Neutral Bus Rogowski ASM 10108266
AKD8 1600A	10108266G6	Figure 40. Neutral Bus Rogowski ASM 10108266
AKD8 2000A	10108266G7	Figure 40. Neutral Bus Rogowski ASM 10108266

AKD-8-Neutral CT Adapter 400A-5000A

This is a miniature Rogowski coil. It mounts between the incoming Neutral disconnect and the breaker trip unit. It converts the signal from an iron Core Neutral sensor to a Rogowski voltage output which is wired to the Breaker’s Trip Unit Neutral input connections.

The Neutral CT Adapter supports iron core Neutral sensors compatible with MicroVersa Trip, MVT RMS-9, MVT Plus & PM, Power Plus, Pro Trip and EntelliGuard TU rated from 150 to 5000 Amps as used in GE switchboards and switchgear from 1979-2015. It is available in five variations (shown in Table below).

Catalog Number	Supported Neutral CT ratings (A)
RNCTA1200 (R)	600, 1200
RNCTA2000 (R)	150, 200, 400, 800, 1000, 1600, 2000
RNCTA3000 (R)	3000
RNCTA4000 (R)	2500, 3200, 4000
RNCTA5000 (R)	5000

Wiring Diagram

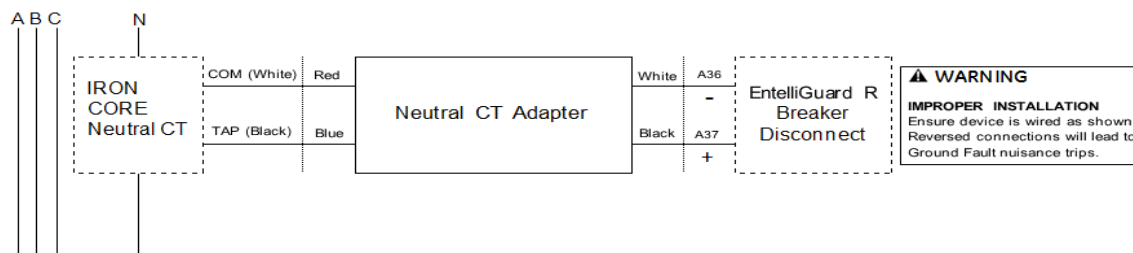
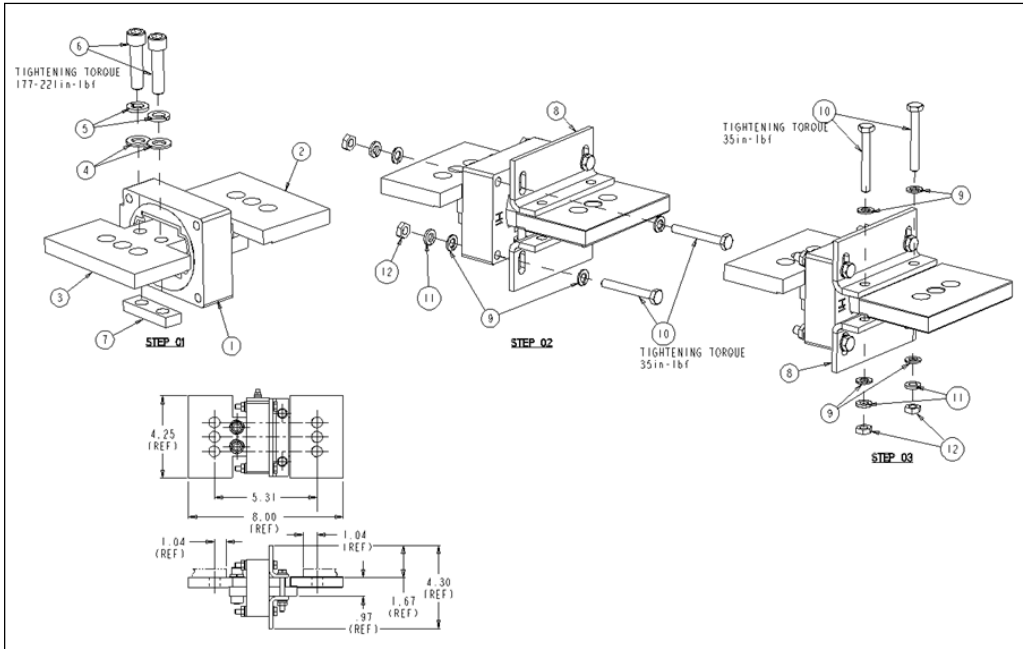

Figure 48 shows a typical Rogowski assembly.

Figure 48. Neutral Bus Rogowski ASM 10108266



Procedures

NOTICE

PRODUCT DAMAGE

- Write down the orientation of the existing Iron core CT and the polarity of the connections. The orientation and polarity needs to be matched when the air core Rogowski is assembled in the cable compartment. Do not allow the circuit breaker to hit a hard surface while handling.

1. Ensure that the LVS has been de-energized and the breaker in the compartment being retrofit is switched off and removed from the LVS.
2. Open the door on the rear of the compartment to access the Cable/ Bus compartment of the LVS
3. Note that the existing neutral CT assemblies are usually mounted vertically on two copper bus bars placed horizontally.
4. Disconnect the wires that are attached to the existing CT assemblies and place them such that they do not interfere with the replacement of the CT assemblies.
5. Unfasten and remove the bolts that hold the neutral disconnect assemblies to the horizontal bus bars. Keep the hardware in a secure location for reassembly.
6. Be careful while handling the CT assemblies such that they do not fall down or damage other components within the LVS.

7. Replace the old CT assembly with the new Rogowski assembly on the horizontal bus bars and fasten it using the hardware previously removed.
 8. Connect a “twisted pair” of wires from the compartment neutral disconnect to the Rogowski CT. In case of damaged wire, the same must be replaced with new ones as already mentioned.
 9. Check for continuity from the CT leads to the plungers on the neutral disconnect assemblies within the LVS compartment. Be sure to orient the CT and wires for proper polarity.
- The new Rogowski assemblies are installed and ready for use.
 - Tools required: Wrenches, wire stripper, wire cutter, continuity tester.

AKD-8—Multi-Source Ground Fault

Retrofills can be used in the following ground fault applications:

- Single Source Feeder breakers, 3 wire or 4 wire
- Main Circuit breakers, 3 wire or 4 wire

For 4 wire multi-source Ground Fault systems, the Retrofill should be ordered with a neutral CT adapter. These neutral CT adapters are compatible with MVT style neutral sensors. This will allow the new breaker to operate with the existing Neutral CT in most cases.

Example : Neutral sensor Cat numbers beginning with TSVG... & CT part #'s 139C4970G#’s.

Please note that these neutral CT adapters are not compatible with Power Sensor or SST style neutral sensors. Replace an SST Neutral CT with a TSVG...BK iron core sensor which will be compatible with the Neutral CT Adapter.

Note: For 4 wire multi-source Ground Fault systems using Rogowski sensors is more difficult and requires that an external GF summing CT scheme must be implemented. This applies to Main—Tie—Main systems or systems with a Main source and then a back-fed generator source.

Wiring Diagram for the AK/AKR Retrofill

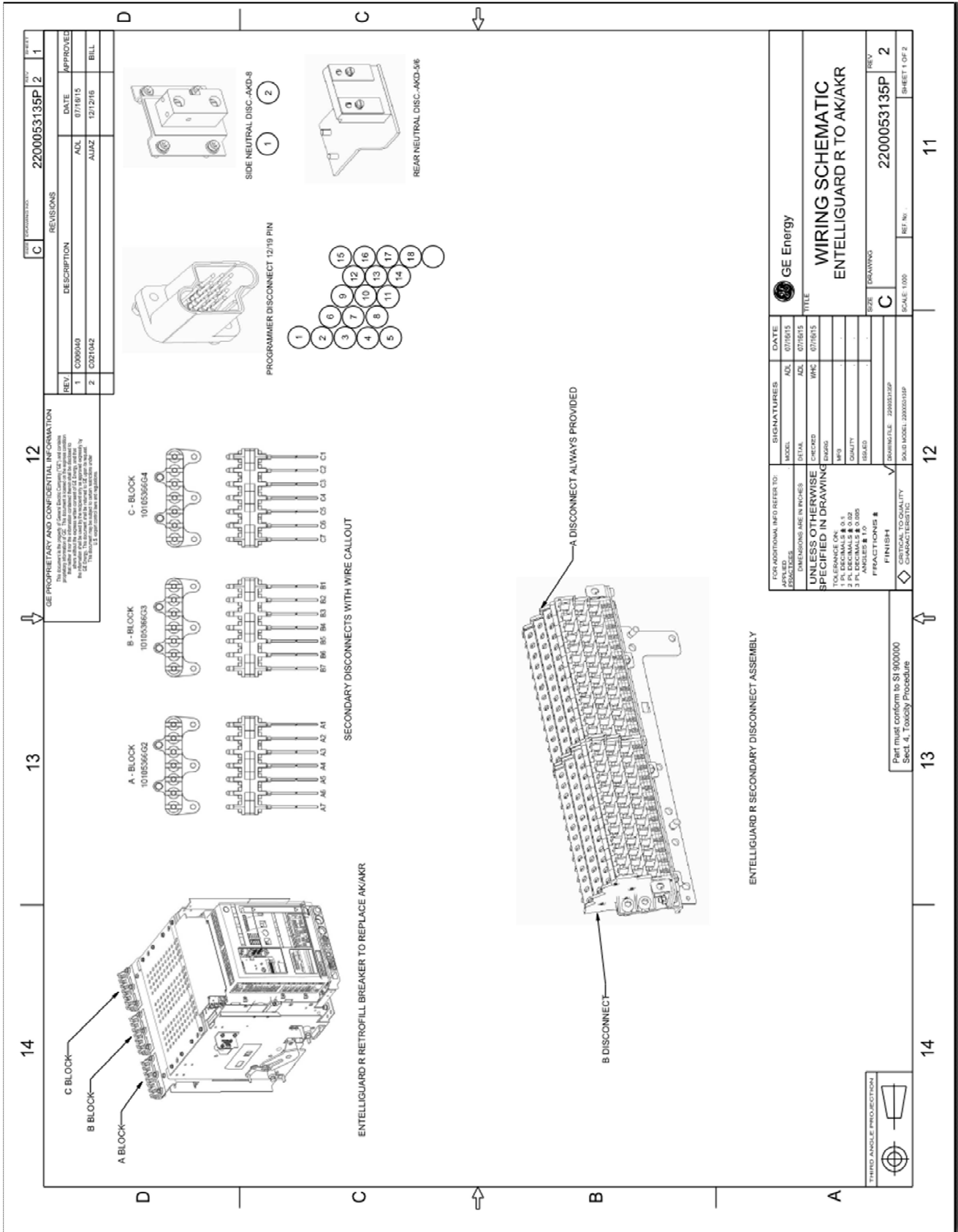

NOTES:

GE Energy Connections

41 Woodford Avenue
Plainville, CT 06062
www.geindustrial.com

© 2016 General Electric Company



*Trademark of the General Electric Company and/or its subsidiaries

DEH41549 R05 12/16