

NP0800 Front-End Power Supplies: 85 Vac to 264 Vac Input, 48 Vdc to 56 Vdc Output; 800 W



Applications

- Routers/switches
- LAN/WAN/MAN applications
- File servers
- Indoor wireless
- Telecommunications equipment
- DSLAM
- Dial aggregate servers
- Advanced workstations
- Mass storage

Description

The NP0800 front-end power supplies are specifically designed to operate as an integral part of a complete distributed power system. A full complement of alarm and shutdown features have been incorporated into the power supply to protect the system in the event of a fault condition. The flexible feature set makes this front-end power supply an excellent choice for applications requiring modular ac-to-dc bulk intermediate voltages, such as distributed power. Features reflect an emphasis on worldwide acceptance of this power system.

Features

- Universal ac input
- 800 W output
- Power-factor correction (meets IEC*1000-3-2 requirements)
- Overvoltage and overcurrent protection
- Overtemperature protection
- Redundant parallel operation
- Remote on/off
- Active load sharing
- Remote sense
- Hot insertion/removal (hot plug)
- Power fail warning
- Fault alarm
- Overtemperature warning
- Front panel LED indicators
- UL†60950 Recognized, CSA‡ C22.2 No. 60950-00 Certified, and VDE§ (IEC60950) Licensed (UL and c-UL Listings are provided at the shelf level.)
- CE mark meets 73/23/EEC and 93/68/EEC directives**

* IEC is a trademark of International Elektrotechniker Commission.

† UL is a registered trademark of Underwriters Laboratories, Inc.

‡ CSA is a registered trademark of Canadian Standards Association.

§ VDE is a trademark of Verband Deutscher Elektrotechniker e.V.

** This product is intended for integration into end-use equipment.

All the required procedures for CE marking of end-use equipment should be followed. (The CE mark is placed on selected products.)

Electrical Specifications

Input Specifications

Table 1. Input Specifications

Parameter	Min	Typ	Max	Unit	Note
Input Voltage	85	120	135	Vac	Unit will shut down if line voltage drops below either range for more than 100 ms. Unit will start at 5 V over minimum value.
	150	230	264	Vac	All output parameters are maintained when operating from line voltages up to 300 Vac.
Input Frequency	47	—	63	Hz	—
Input Current	—	—	10	—	@ 100 Vac.
	—	—	9	—	@ 120 Vac.
	—	—	7	—	@ 150 Vac.
	—	—	5	—	@ 208 Vac.
Inrush Current (peak)	—	—	40	A _{peak}	Measured at 25 °C for all line conditions.
Input Leakage Current	—	—	3.2	mA	255 Vac, 60 Hz.
Power Factor	0.98	0.995	—	—	From 50% to full load @ 120 Vac or 230 Vac. Line harmonics meet EN61000-3-2 and JEIDA MITI standards.
Efficiency	—	84	—	%	@ 100 Vac @ V _{OUT} ≥ 52 V.
	—	88	—	%	@ 230 Vac @ V _{OUT} ≥ 52 V.
Lightning Surge and Transients (error-free operation)	20	—	—	%	Surge above highest rated nominal for 2 seconds. EN/IEC 61000-4-4, Level 3; IEC 61000-4-5, Installation Class 3; ANSI C62.41 B2.
Hold Over Time	—	20	—	ms	Alarm 5 ms prior to shutdown. Output voltage allowed to droop to 45.6 V into a constant power load.
EMC (radiated)	—	—	—	—	FCC and CISPR 22 (EN55022) Class B radiated emissions.
EMC (conducted)	—	—	—	—	FCC-CFR, Part 15, subpart B, Class B and CISPR 22 (EN55022) Class B.

Electrical Specifications (continued)

Output Specifications

Table 2. Output Specifications

Parameter	Min	Typ	Max	Unit	Note
Vo Set Point	—	52.0	—	Vdc	Set point tolerance is 1%. Default set point is 52 V.
Total Output Power	—	—	800	W	Total output power of all outputs not to exceed 800 W.
Programmable Vo Range	48	—	58	Vdc	Factory programmable in 60 mV increments.
Regulation	-2	—	2	%	Total regulation line, load, aging, and temperature.
V _{fullpower}	48	—	58	Vdc	Full power is 800 W.
V _{hiccup}	—	4	12	Vdc	Current tail does not start before 12 V.
I _{OUT}	0	—	15.4	A	@ 52 V.
I _{LIM}	12.5	—	20	A	Current limit set point. Factory programmable in 100 mA increments. Tolerance will be -0, 3 A of set point.
I _{shortcircuit}	—	—	200	% of I _{OUT}	—
Ripple and Noise	—	—	250 45	mVp-p dBmC	50 MHz bandwidth under any load condition.
Output Rise Time	20	—	100	ms	Measured between the 10% and 90% points of the waveform. At any normal load condition. Voltage slope will always be greater than or equal to zero.
Turn-On Overshoot	—	0	1.5	Vdc	The overshoot is with respect to the initial set point.
Backup High Voltage Shutdown	58.4	—	60.2	Vdc	Within 50 ms when the supply is margined to 58 V, no step change in load will cause high voltage shutdown. The backup high voltage shutdown shall be analog (completely independent of any microcontroller) and rely on an independent reference.
Transient Response (Voltage Deviation)	—	—	5	%	25% step at 25% to 75% static. 10% step at 0% to 25% static. 100% step, no OVP. The rise and fall time of the load current shall be 250 ± 25 μs. The induced output voltage transient shall settle to within 1% of the final voltage in less than 10 ms. Resistive load.
Capacitive Load	—	500	1700	μF per A	7,500 μF Typ.
Reverse Output Current Protection	—	—	0.5	A	ORing diode.
Turn-on Delay	—	—	3.5	s	Measured from application of valid ac voltage for default unit set point.

Electrical Specifications (continued)

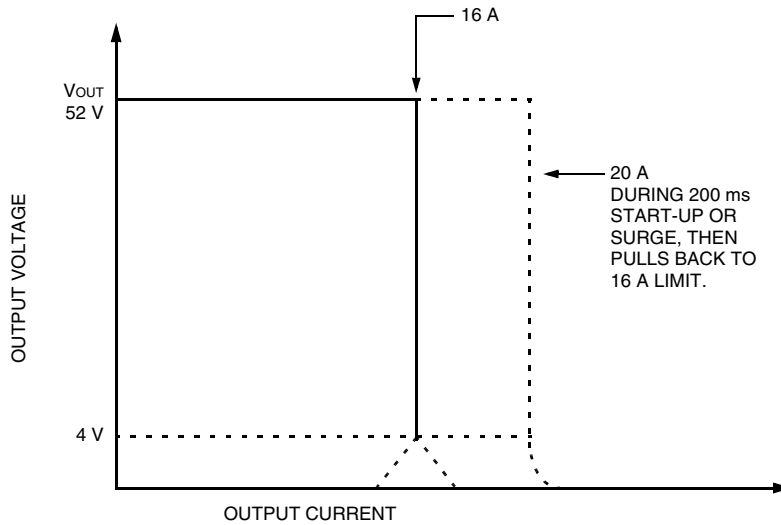

8-1283 (F).k

Figure 1. NP0800 Output Voltage and Current

The power unit will operate in the constant voltage mode until the load current exceeds $I_{L, min}$, which is 105% of

$I_{O, max}$. The power supply during startup will allow 20 A for 200 ms to start BMP modules. After the initial startup, the current limit reduces to 16 A.

Physical Specifications

Table 3. Physical Specifications

Parameter	Min	Typ	Max	Unit	Notes
Length	—	10.78	—	inches	—
Width	—	5.61	—	inches	Chassis
	—	5.75	—	inches	Face plate
Height	—	3.38	—	inches	Chassis
	—	3.38	—	inches	Faceplate
Weight	—	7	—	lbs.	Without shipping package
Weight	—	8	—	lbs.	With shipping package

Warranty Information

When used within specified operating conditions, Tyco Electronics will warrant that this product will conform to published specifications and is free of material and workmanship defects for the period of two (2) years from date of manufacture. This warranty applies only to units having the date code of warranty period or less when returned to Tyco Electronics for repair. Tyco's liability will be limited to the repair or replacement, at our option, of the returned unit. Our warranty does not extend to any unit which has been subjected to abuse, misuse, or neglect or to units that have been repaired or altered by anyone other than Tyco Electronics or an authorized agent. Additional details are provided in contract documents and other full-warranty statements.

Environmental Characteristics

Table 4. Environmental Characteristics

Parameter	Min	Typ	Max	Unit	Note
Storage Temperature	-40	—	85	°C	—
Operating Temperature (air inlet to power unit)	-5	—	55	°C	Airflow front to back with 3 inch clearance for exhaust air in unpressurized enclosure.
Humidity	5	—	95	%	Relative humidity noncondensing.
Altitude	-60 (-200)	—	4000 (13000)	m (ft.)	For operation above 2500m (8000 ft.), maximum operating temperature is derated by 2°C per 305m (1000 ft.).
Shock and Vibration	—	—	—	—	1) Meets Network Equipment Building System (NEBS) GR-63-CORE Level 3. 2) ASTM-D-4728-91 with an 8 hour duration on each axis.
Earthquake Rating	4	—	—	zone	All floors, when installed with corresponding Power System in 19 in. rack.
ESD	3	—	—	level	Error free per EN/IEC 61000-4-2 (6 kV contact discharge, 8 kV air discharge).
Electromagnetic Immunity	—	—	—	—	Error free-tested to EN/IEC 61000-4-6 (conducted). Error free-tested to EN/IEC 61000-4-3 (radiated) level 3; 10 V per meter.
Electrical Fast Transient Burst	50	—	—	occurrences at 1 minute intervals	Damage free EN/IEC 61000-4-4 Level 3.
Reliability (calculated)	700k	—	—	hours	Fully loaded in a 25 °C ambient with fan at normal speed per Tyco Electronics Reliability Information Notebook (RIN).

Physical Descriptions

Definition of Terms

Power-Factor Correction

All NP-Series power supplies comply with the specifications set forth in *IEC 1000-3-2*.

Input Overcurrent Protection

An internal fuse is provided in each unit for input protection in compliance with safety agency requirements.

Overcurrent Protection

In the event of an overload condition, the power supply limits the output current. See Figure 1 for details.

Overvoltage Protection

The power unit turns itself off before the output voltage reaches a specified threshold.

Overtemperature Protection

In the event of an overtemperature condition, the power unit protects itself by shutting off. Restart can be accomplished with a toggle of remote on/standby.

ORing Diode

A diode at the output of the power unit protects the dc bus in the event of a power supply failure or hot plugging of the power unit.

Remote On/Standby

An opto-isolated input signal. An external 1 mA, 5 V source activates a standby condition in the power module. (Input resistor is provided.)

Voltage Margining

Accomplished only with a control enhancement card installed.

Power Fail Warning (PFW)

Communicates incipient loss of output power. Opto-isolated and pulled to ground to activate.

Alarm Return (AR)

Common return for all opto-isolated signals including OTW, remote on/standby, and PFW.

Current Share (I_SHARE)

A single-wire interface between each of the power units forces them to share the load current.

Remote Sense (R_SENSE)

These signals permit the power units to compensate for a voltage drop across the output distribution.

Reset

Toggle the remote on/standby to accomplish reset.

Redundant Bias Supply (EX_BIAS_12—15 V)

This protected feed from the internal bias supply may be used to externally power the alarm and control logic.

AC Line Discrimination

The unit senses the input range at power-up and shuts the unit down if the input drops below that line range for a specified period of time.

Front Panel LEDs

AC OK (green): The unit has input ac in the correct range.

DC OK (green): The unit is powered up and the output is in regulation.

Fault (red): The unit has detected an internal fault.

Status Signals

The following are the optically isolated open-collector signals (minimum 1 mA sinking capability):

Fault: The unit has detected an internal fault.

Overtemperature Warning (OTW): The unit is overheating; shutdown is imminent (8 second warning).

Power Fail Warning: The output of the power unit will fail in at least 5 ms.

Front-End Power Supply Interfaces

Input Voltages

The product can be used with any standard global line voltage; consult the factory for any particular regional application concerns.

Input Connector

The ac input connection is through an *IEC 320 C-13* type connector rated at 10 A/250 Vac in Europe/Asia, and 15 A/120 Vac in North America.

Grounding

Frame ground can be connected so that the output may have either a positive or negative ground.

Connector Information and Signal Definitions

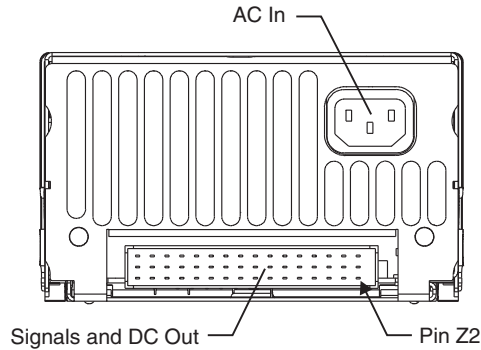

4-0001

Figure 2. NP0800 Connectors

DC Connector

Each NP0800 rectifier has a DIN 41612 Type F Connector with level 2 gold plating.* Pin-out configuration and function descriptions are as described in Table 5.

Table 5. Rectifier Output Connector Pin Outs

	32	30	28	26	24	22	20	18	16	14	12	10	8	6	4	2
D	Missing Module + (Line)	EX_BIAS_12-15V (Bus)	PFW+ (Line)	OTW + (Bus)	A2 (Bus)	SERIAL INTERRUPT (Bus)	Future Use Bus (Bus)	SHELF PRESENT (Bus)	Vout - (Bus)	Vout - (Bus)	Vout - (Bus)	Vout - (Bus)	Vout + (Bus)	Vout + (Bus)	Vout + (Bus)	Vout + (Bus)
B	Long Pin Vout - (Bus)	A3 (Bus)	ALM_RTN (Bus)	FUTURE USE 2 (Bus)	A1 (Line)	SERIAL CLOCK (Bus)	RS485- (Bus)	Missing Module - (Line)	Vout - (Bus)	Vout - (Bus)	Vout - (Bus)	Vout - (Bus)	Vout + (Bus)	Vout + (Bus)	Vout + (Bus)	Long Pin Vout + (Bus)
Z	A4 (Bus)	REMOTE_ON/STBY (Line)	I_SHARE (Bus)	FAULT + (Bus)	A0 (Line)	SERIAL DATA (Bus)	RS485+ (Bus)	SERIAL RTN (Bus)	Vout - (Bus)	Vout - (Bus)	Vout - (Bus)	RS- (Bus)	Vout + (Bus)	Vout + (Bus)	Vout + (Bus)	RS+ (Bus)

Note: The (Bus) and (Line) suffixes are indications of how signals are wired on the standard 19 inch shelf.
(Bus) indicates that this signal is routed in parallel to all rectifiers in a specific shelf.
(Line) indicates that each rectifier is individually connected through that pin.

* Please see the *NP Rectifier and NP Shelf Application Note* for more information.

Outline Drawings

NP0800 Rectifier

Weight = 7 lbs.

Dimensions are in millimeters and (inches).

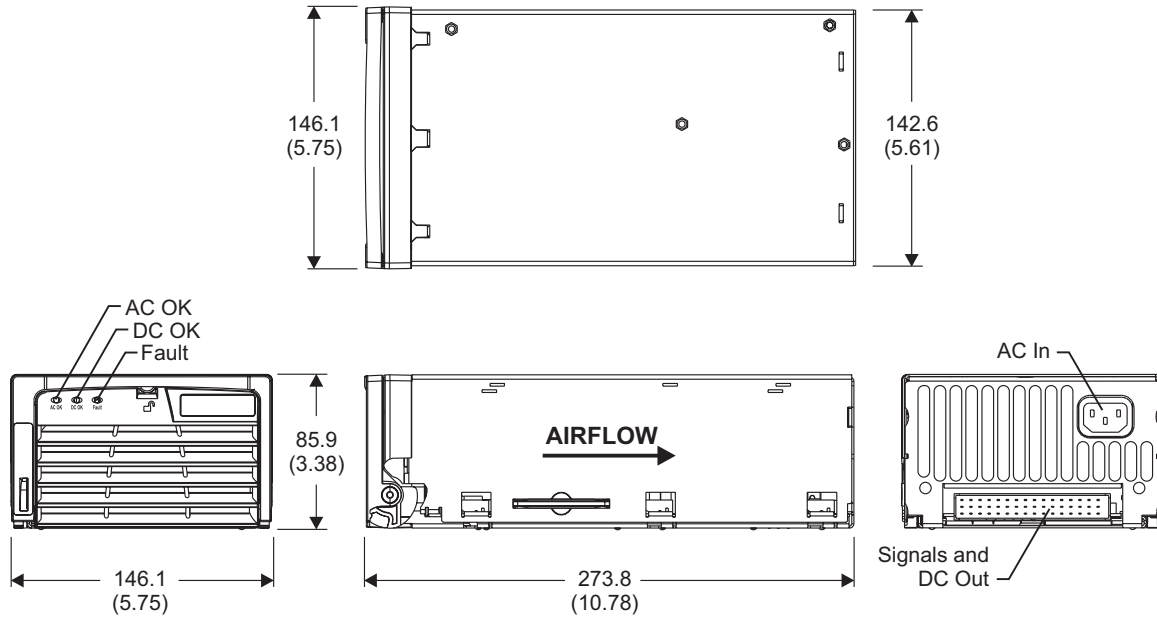

4-0007

Outline Drawings (continued)

NP0800 System Dimensions

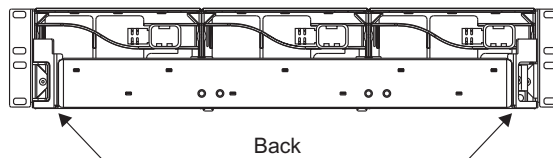
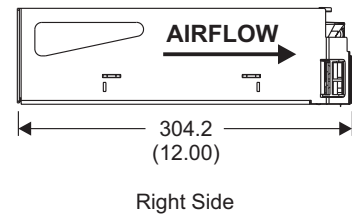
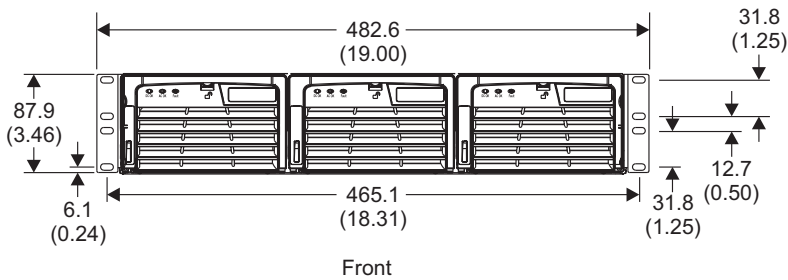
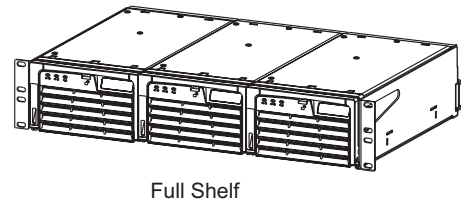
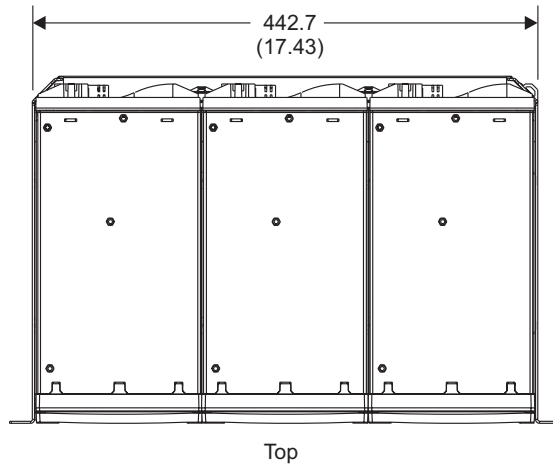

DC output connections for one pair of 6 AWG wires per side. Wires may dress up, down, back, or sideways.

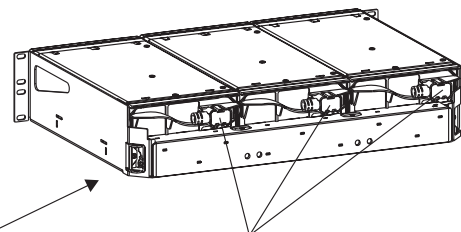

Ordering Information

The NP0800 is intended to be used with the NP Shelf and can be ordered individually or as part of a system.

Table 6. Product Codes

Product	Includes	Comcode	Shipping Weight
NP0800	One (1) NP0800 Rectifier, 52 V	108957929	8 lbs.
NP Shelf	One (1) NP Shelf w/dc cables*	CC109121844	9 lbs.
NP Shelf LC	One (1) NP Shelf without dc cables	CC109122537	8 lbs.

* Includes redundant 6 gauge, 3 ft. 10 in. long, dc output cables.

AC Cord Sets

The NP0800 rectifiers integrate the ac cord set into the hot swap architecture. The benefits of this approach are higher quality, higher reliability, and lower cost. To realize this benefit, the cord set must be selected and ordered from the list in Table 7.

Table 7. AC Cord Sets*

Region	AC Cord Set	Appliance Connector	Wall Plug	Comcode
North America	15 A/125 Vac, 10 A/250 Vac [†]	IEC60320 C-13 Right Angle	NEMA 5-15P	848545166
Italy	10 A/250 Vac	IEC60320 C-13 Right Angle	MP231 CEI13-16/VII	848545216
Europe	10 A/250 Vac	IEC60320 C-13 Right Angle	IEC884/ CEE 7/7 Exception to CEE 7/7: Switzerland SEV 1011	848545208
United Kingdom	13 A/250 Vac	IEC60320 C-13 Right Angle	BS1363, w/13 A fuse	848545224
Australia	10 A/250 Vac	IEC60320 C-13 Right Angle	AS3112	CC848788661
Argentina	10 A/250 Vac	IEC60320 C-13 Right Angle	IRSM 2073:1982	CC848788678
China	10 A/250 Vac	IEC60320 C-13 Right Angle	GB2099.1-1996	CC848788686
Japan	15 A/125 Vac	IEC60320 C-13 Right Angle	JIS 8303	848545182

* Contact factory for RoHS status.

[†] For high-line operation, qualified service personnel must replace the wall plug with an appropriate *UL* Listed/*CSA* plug, as required in compliance with local electrical codes and standards. (*UL* is a registered trademark of Underwriters Laboratories, Inc.)

Table 8. Alarm Cable

Product	Includes	Comcode	Shipping Weight
Analog Alarm Cable	One (1) DB9 Cable Harness	108842865	1 lb.

Notes



World Wide Headquarters

Tyco Electronics Power Systems, Inc.
3000 Skyline Drive, Mesquite, TX 75149, USA
+1-800-843-1797
(Outside U.S.A.: +1-972-284-2626)
power.tycoelectronics.com
e-mail: techsupport1@tycoelectronics.com

Europe, Middle-East and Africa Headquarters

Tyco Electronics (UK) Ltd
Tel: +44 1344 469 300, Fax: +44 1344 469 301

Caribbean-Latin America-Brazil Headquarters

Tyco Electronics Power Systems
Tel: +56 2 209 8211, Fax: +56 2 223 1477

Asia-Pacific Headquarters

Tyco Electronics Singapore Pte Ltd
Tel: +65 6416 4283, Fax: +65 6416 4299

India

Tyco Electronics Systems India Pte Ltd
Tel: +91 80 841 1633 x3001

Tyco Electronics Corporation reserves the right to make changes to the product(s) or information contained herein without notice. No liability is assumed as a result of their use or application. No rights under any patent accompany the sale of any such product(s) or information.

©2006 Tyco Electronics Power Systems, Inc., (Mesquite, Texas) All International Rights Reserved.
Printed in U.S.A.

November 2006
DS03-020 Rev 4