



Mounting a 3-Coil Trip for anti-single-phasing application only

Cat. No. TJKST316 for J600 Line Breakers

Cat. No. TKMAST316 for K1200 Line Breakers and TB4, TB6 and TB8

IMPORTANT NOTE U/L listing is voided when the circuit breaker is modified to add an accessory. The U/L label must be destroyed.

APPLICATION

The three-coil shunt trip accessory is designed for the molded case circuit breaker in application with current-limiting fuses. The accessory prevents single-phasing on a three-phase system when a single fuse blows.

Each coil of the shunt trip is wired across a fuse so that arcing voltage across any of the three fuses will cause the breaker to trip. When a coil is energized by the fuse arcing voltage, the solenoid core releases the spring-biased latch allowing the shaft and hook to move the breaker trip bar OFF. The breaker must be reset before it can be closed again.

If the breaker is closed on an open fuse, the shunt trip will re-open it immediately.

THE 3-COIL SHUNT TRIP ACCESSORY IS RATED FOR 3-PHASE 208-600 VOLTS AC. COILS ARE NOT RATED FOR CONTINUOUS CURRENT. THE DEVICE MUST BE WIRED SO THAT IT IS DE-ENERGIZED WHEN BREAKER CONTACTS ARE OPEN.

INSTALLATION

The shunt trip accessory is used on left-pole of the breaker only. It fastens to the trip unit on the K1200, on the breaker base on the J600 and occupies the space adjacent to the operating mechanism of the breaker. The spring-loaded plunger extends through a knockout in the trip unit case to operate the breaker trip bar. The accessory does not interfere with normal tripping action of the breaker.

The six leads are brought out through the side of the breaker case.

CAUTION: Circuit breakers and components should be handled, inspected, or removed by qualified personnel only, in accordance with instructions and accepted safety precautions. Completely de-energize the breaker before installing the accessory.

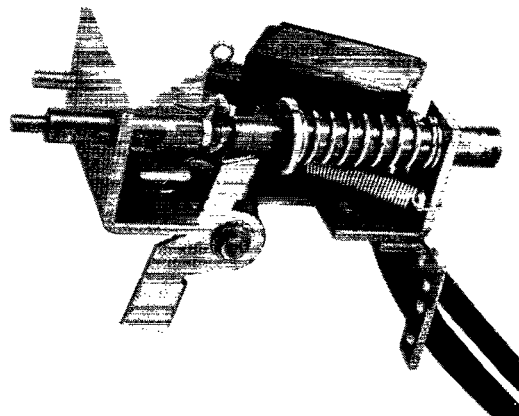

3-coil shunt trip for J600

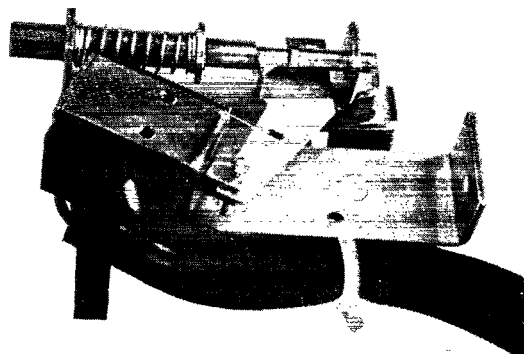

3-coil shunt trip for K1200

These instructions do not purport to cover all details or variations in equipment nor to provide for every possible contingency to be met in connection with installation, operation or maintenance. Should further information be desired or should particular problems arise which are not covered sufficiently for the purchaser's purposes, the matter should be referred to the General Electric Company.

TO INSTALL 3-COIL SHUNT TRIP CAT. NO. TJKST316 in J600 BREAKER

page 2

STEP 1 Remove the cover from the breaker by unscrewing the four cover screws. (Screws closest to the breaker handle.) Do not remove the trip unit.

STEP 2 Be sure the breaker is de-energized or removed from circuit. With 0.125 diameter drill, drill thru hole on pole where accessory is to be installed. This hole should be drilled from the back of the breaker. Use the spotting hole closest to the trip unit for locating.

Drive a small screwdriver thru the knockout groove in the trip unit. Gently pry outward to remove the knockout. Note: Some trip units have a rectangular knockout which can be removed by inserting a screwdriver in the slot and prying up. Be careful not to eject chips into the trip unit case.

TURN THE BREAKER ON

STEP 3 Make sure that the threaded part of the shaft is screwed all the way into the plunger. Grasp the accessory, pulling the plunger back beyond the latching point.

STEP 4 Hold the accessory as shown and insert the plunger thru the knockout, and position in the locating hole. Set the unit in place so that the accessory mounting hole is on top of the hole drilled in STEP 1. The reset lever of the shunt trip must be positioned with respect to the breaker crossbar, as illustrated.

STEP 5 Fasten the accessory in place with the 1" self-tapping screw and lockwasher supplied.

STEP 6 File openings in breaker cover 3-11/16 to 5-3/4" from the trip end of the breaker for bringing leads thru side of breaker.

ADJUSTMENT & CHECK-OUT — SEE PAGE 4

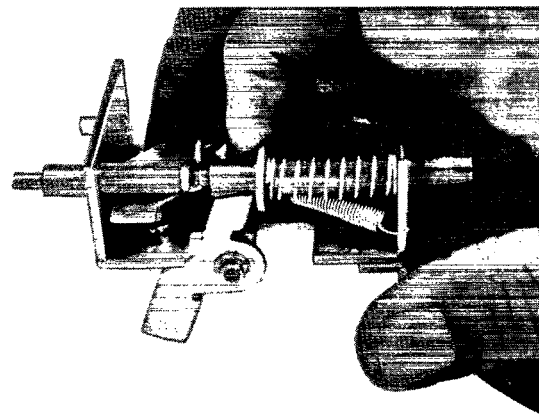
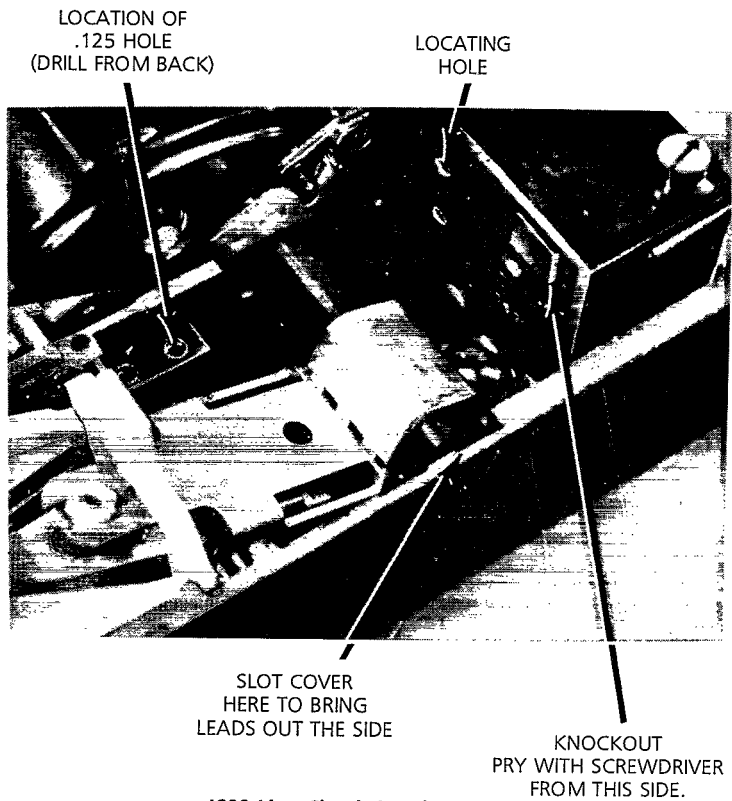

TO INSTALL A 3-COIL SHUNT TRIP CAT. NO. TKMAST316 in K1200 BREAKER

STEP 1 Remove the cover from the breaker by unscrewing the four cover screws. (Screws closest to breaker handle.)

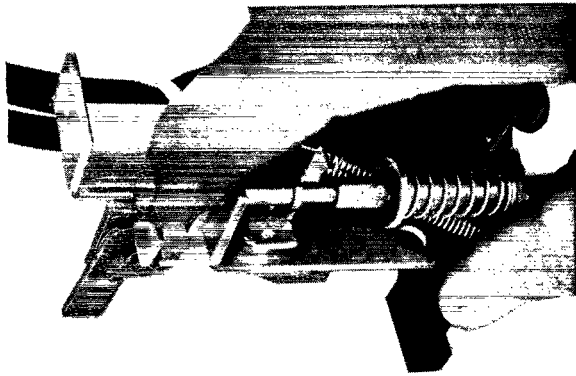

Fig. 1
Holding K1200 Shunt Trip for Assembly

STEP 2 Compress plunger spring as shown in Fig. 1 and locate fibre support in notches of breaker base.

STEP 3 With spring compressed, locate reset portion of trip arm behind cross-bar staple of breaker frame.

STEP 4 Fasten bracket of device to trip unit with self-tapping screw and lockwasher provided.

STEP 5 Leads are brought out through left side of special cover supplied.

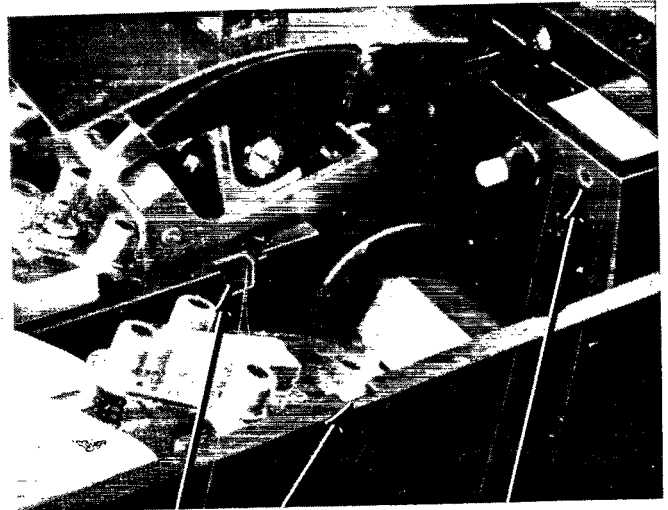

FIBRE SUPPORT
LOCATES IN THESE
NOTCHES.

MOUNTING HOLE

K1200 Line Circuit Breaker

2-POLE SINGLE-PHASE APPLICATION
Three-Coil Shunt Trip

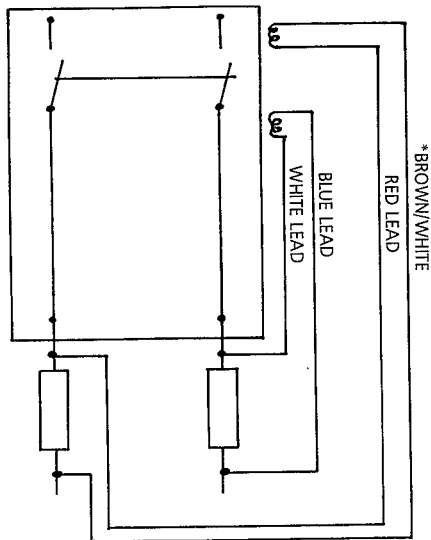

CIRCUIT BREAKER LOAD END

3-POLE THREE-PHASE APPLICATION
Three-Coil Shunt Trip

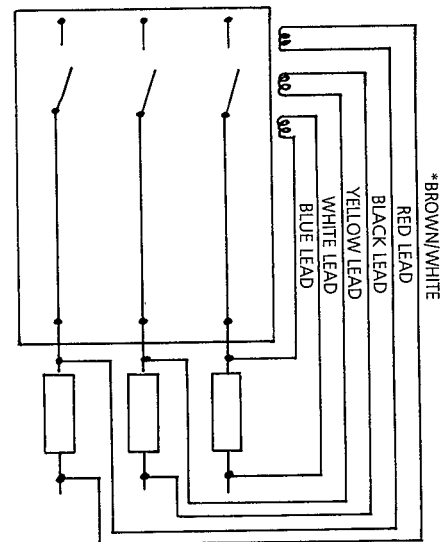

CIRCUIT BREAKER LOAD END

*Formerly Green

CONNECTIONS MUST BE MADE AS SHOWN. TRIP MAY FAIL TO OPERATE IF IMPROPERLY WIRED.

Installation Adjustments & Check-Out for J600 Line 3-Coil Shunt Trip Only

For optimum performance, the shunt trip can be adjusted to compensate for manufacturing variations.

With the breaker in ON position, unlatch the shunt trip by manually pushing the core through the solenoid. Turn the slotted end of the plunger (hold other end with wrench) counter-clockwise until the breaker trips. Then continue two additional turns. To prevent loss of adjustment due to vibration, tighten locknut against plunger with 6-inch lbs. torque.

To check operation, depress the solenoid core completely into solenoid. If breaker does not trip, recheck adjustment.

