



NOTES:  
1. SEE OUTLINE DRAWING 10055790SH1



 <b>Industrial Solutions</b>			
<b>POWER BREAK II CIRCUIT BREAKER 1600-2000 AMP ENCLOSURE</b>			
THIRD ANGLE	SHEET#	DWG NO.	DATE
	1 of 3	GEM3133	10/19
			REV
			1

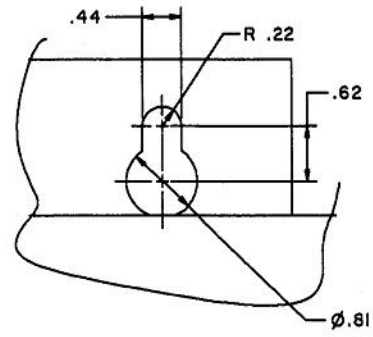
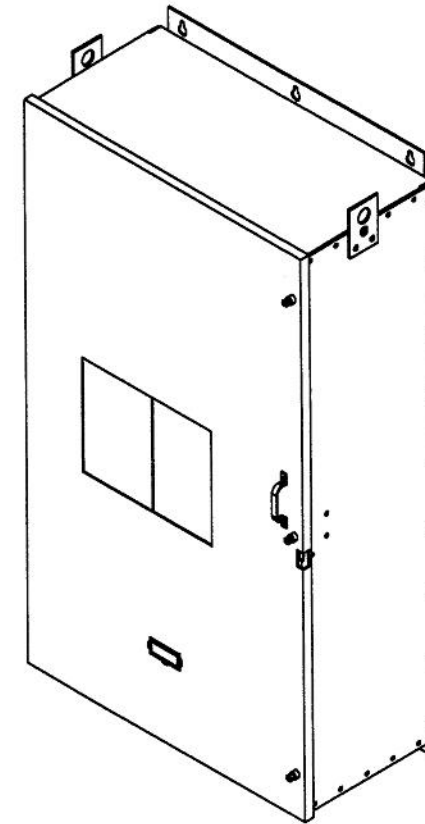
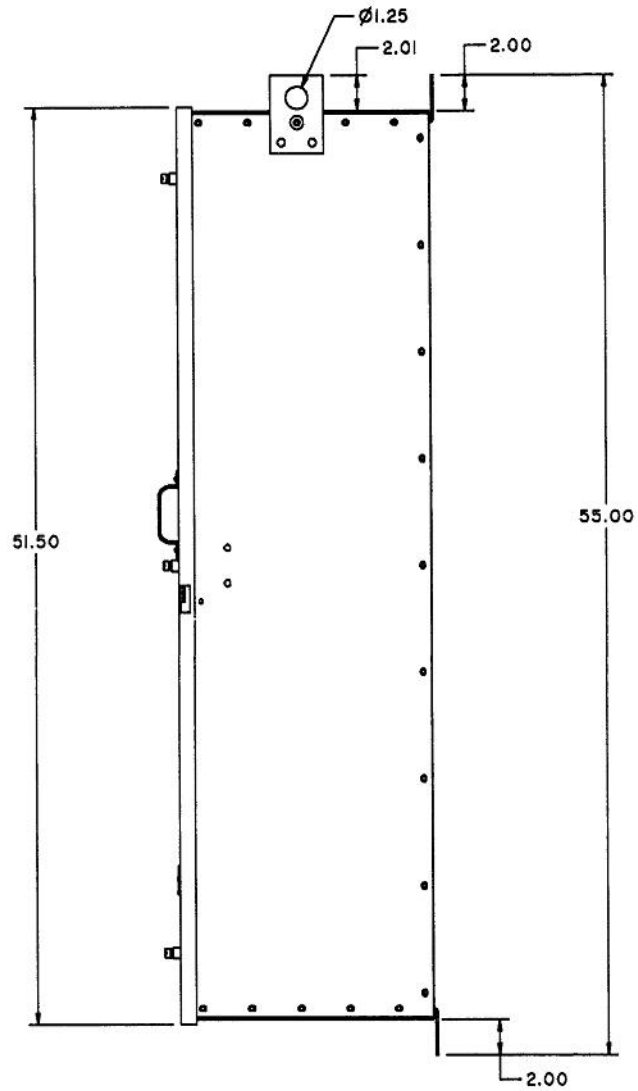
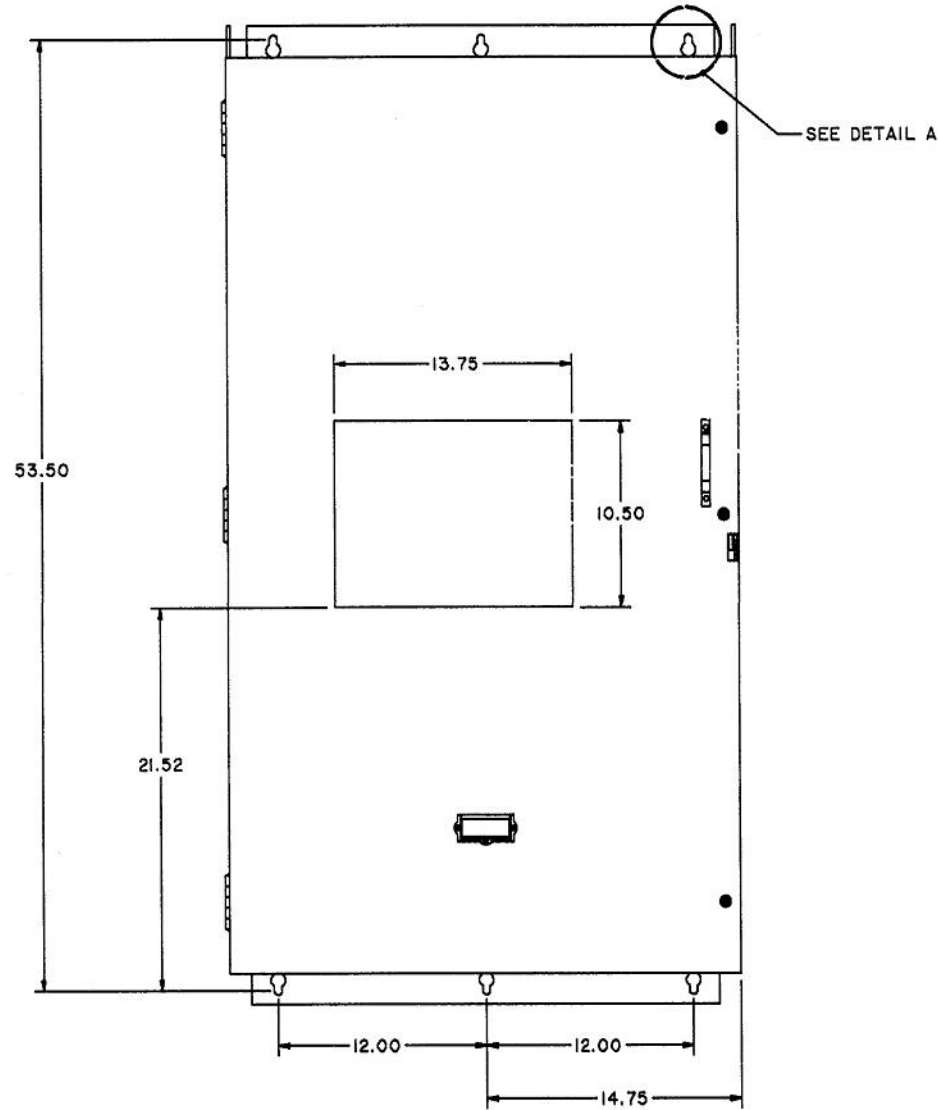
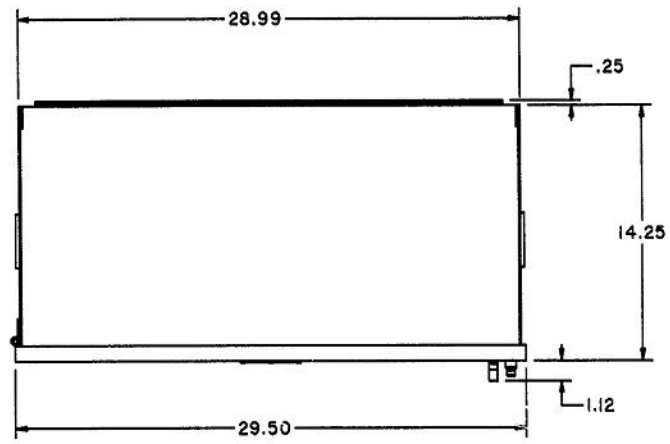

DETAIL A



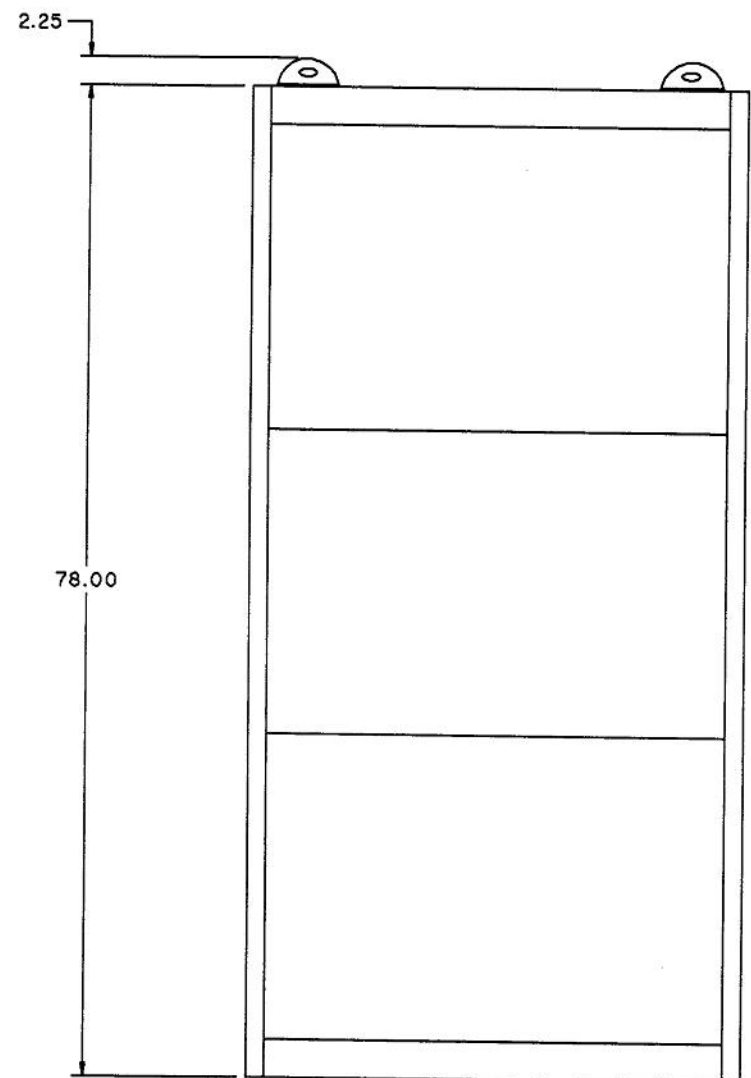
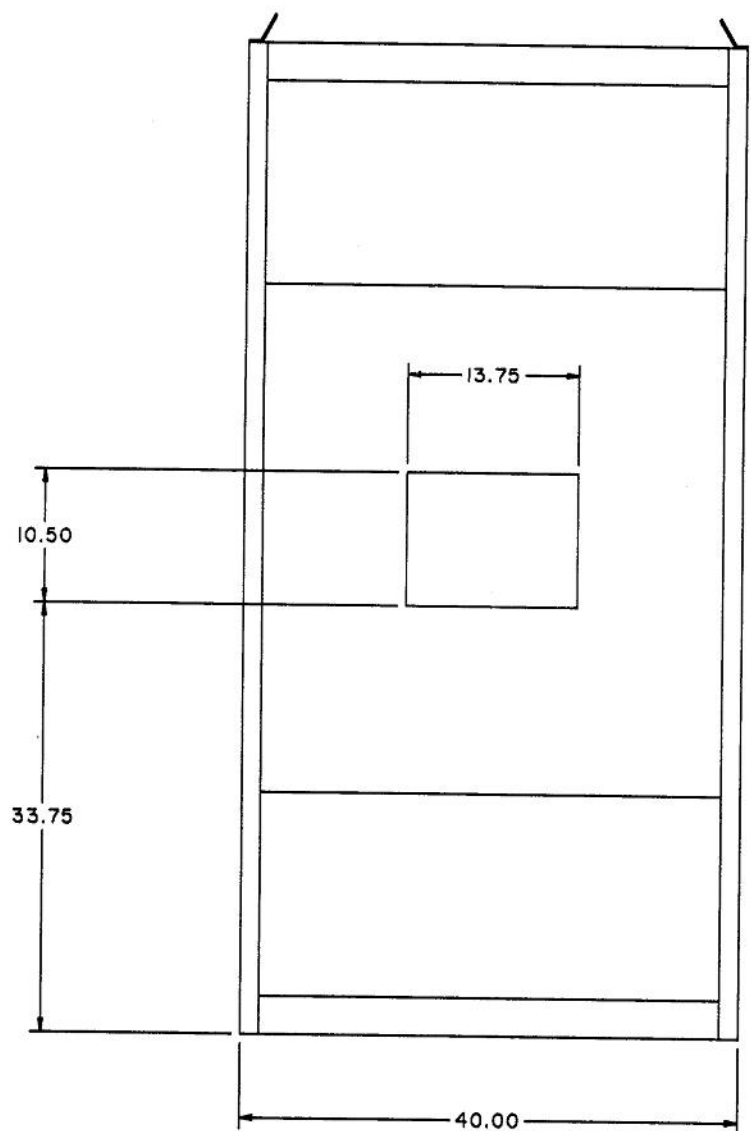
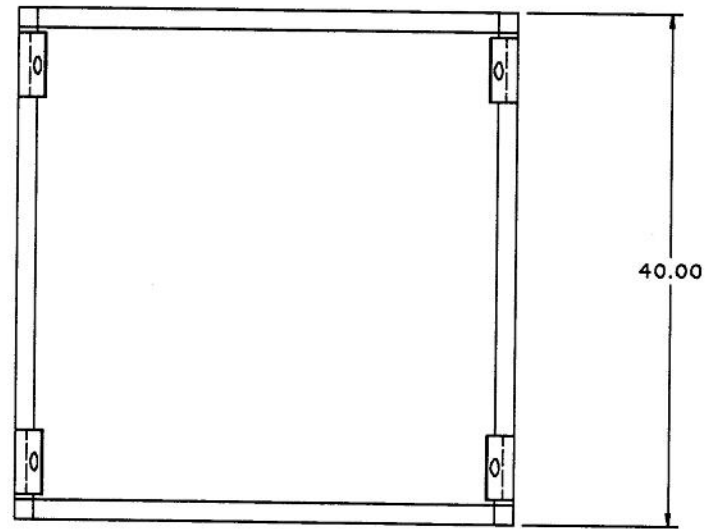

NOTES:  
1. SEE OUTLINE DRAWING 10055847SH1

		<b>Industrial Solutions</b>			
<b>POWER BREAK II CIRCUIT BREAKER 800 AMP ENCLOSURE</b>					
THIRD ANGLE	SHEET#	DWG NO.	DATE	REV	
	2 of 3	GEM3133	10/19	1	



NOTES:  
1. SEE OUTLINE DRAWING 10055960SH1

 <b>Industrial Solutions</b>				
<b>POWER BREAK II CIRCUIT BREAKER FLOOR MOUNT ENCLOSURE</b>				
THIRD ANGLE	SHEET#	DWG NO.	DATE	REV
	3 of 3	GEM3133	10/19	1