

Top View

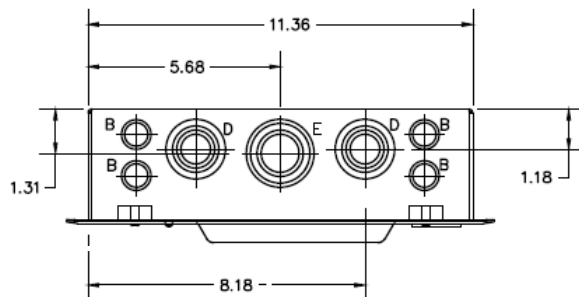

Wire Range Size

(1) #6 - #1 (CU/AL)

Left Side View

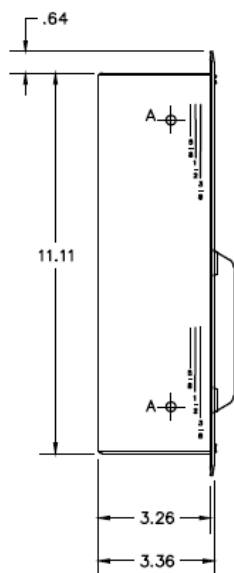

Right Side View

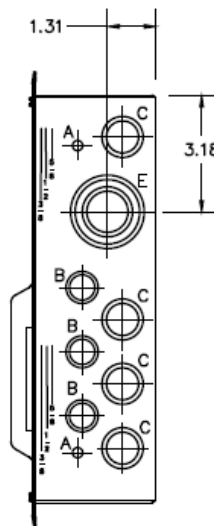

Front View

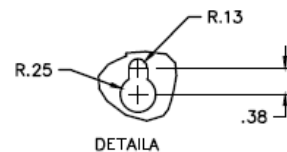
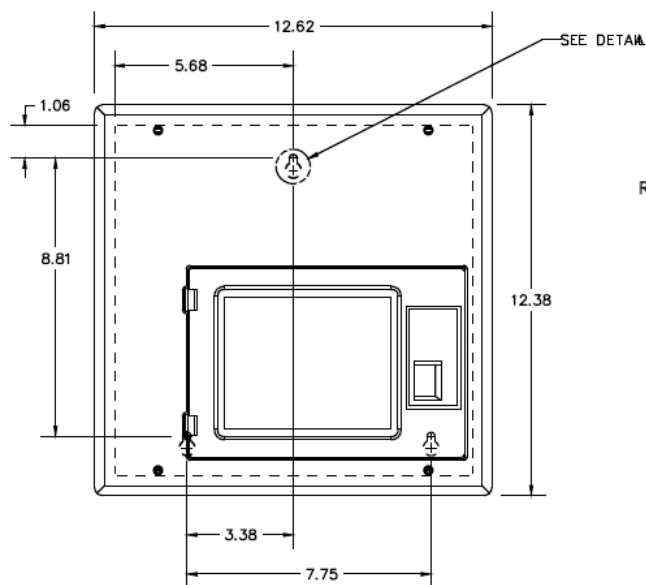

Bottom View

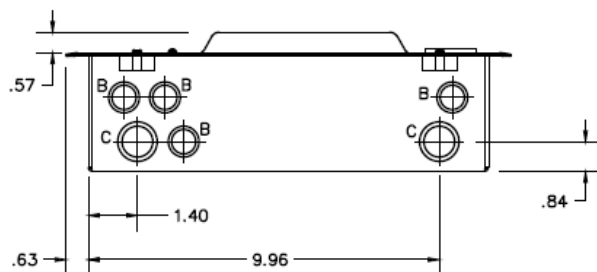

Knockouts

SYMBOL	SIZE	QTY
A	9/32 KO	4
B	3/8 x 1/2 KO	11
C	1/2 x 3/4 KO	6
D	1/2 x 3/4 x 1 x 1 1/4 KO	2
E	3/4 x 1 x 1 1/4 x 1 1/2 KO	2

Note : All Dimensions have ±0.125 Tolerance



Midwest Electric Products
Plainville, CT

MIDWEST LOAD CENTER 8/16 CIRCUIT 125A MLO N1
METALLIC ENCLOSURE FLUSH TOP/BOTTOM FEED

CAT NO	DWG DATE	REV #
MLM812FCUD	04/07/2017	01