

WIRE RANGE:  
#6-2/0 AWG CU-AL

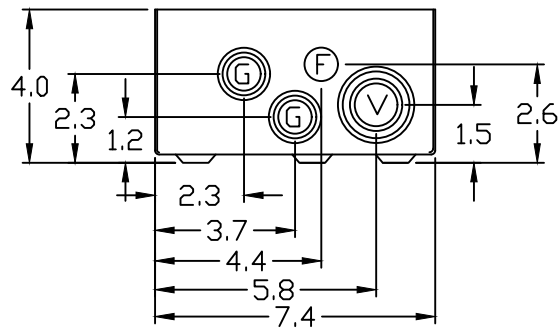

KNOCKOUT TABLE:

F= 1/2" KØ
G= 1/2", 3/4", 1" KØ
V= 3/4", 1", 1-1/4", 1-1/2" KØ

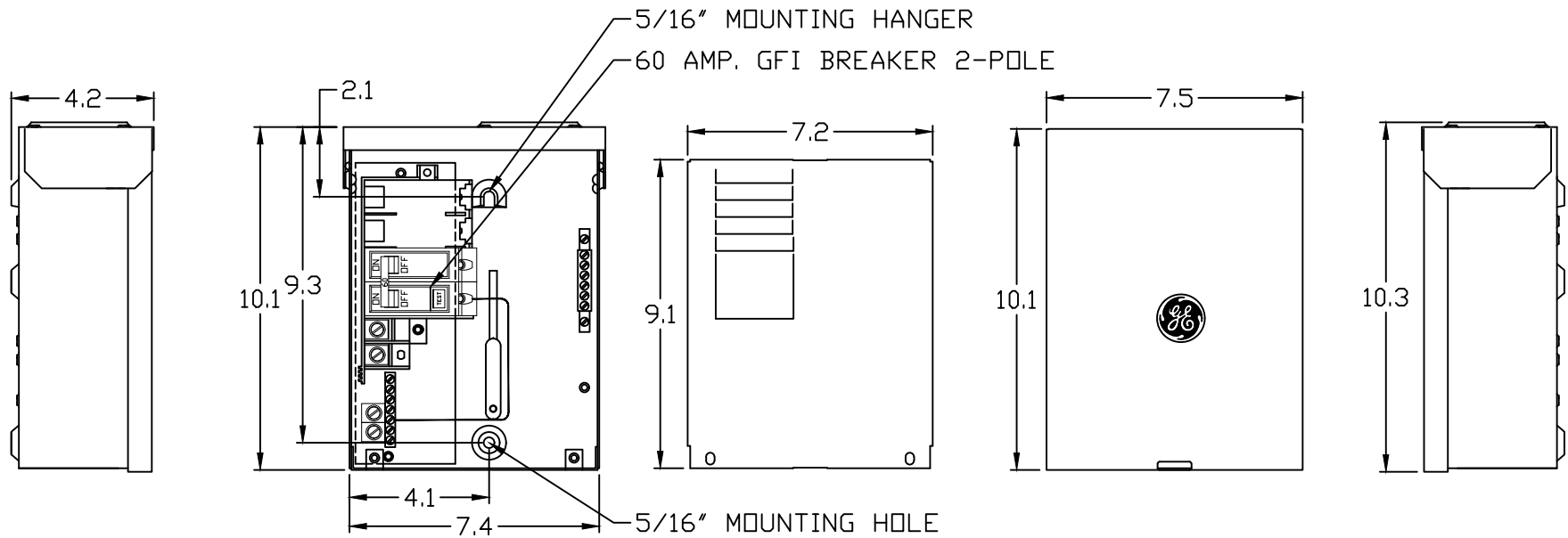

imagination at work

TL412R260GF  
OUTLINE DRAWING

DWG NO.	DATE	REV
265A6315SH9	03/13/19	01