

Top View

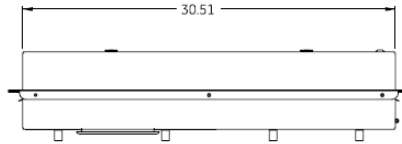

Main Wire Size Terminals

1/2" Studs Provisions for UL Listed One or Two Hole NEMA Mounting Terminals
 Compression Terminals Limited to 800 KCMIL Single Conductor, HOMAC Series AL-NTN, AL-TN or Equivalent.
 Compression Terminals Limited to 400 KCMIL for Stacking Lugs, HOMAC Series ASL-NTN or Equivalent.
 Pressure Terminals Limited to 1000 KCMIL Single Conductor, ILSCO Type TA or Equivalent.
 Pressure Terminals Limited to 350 KCMIL Single Conductor, ILSCO Type AU or Equivalent.

Notes

Utility main breaker (A2A) factory installed. Optional secondary main can be field installed

Front View

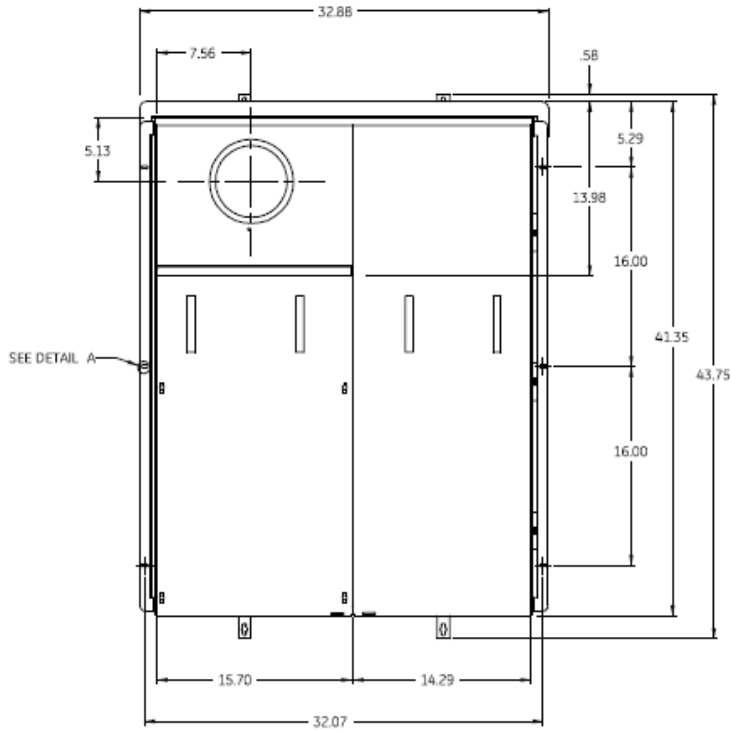

Side View

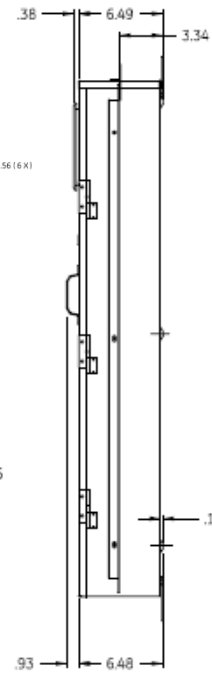

Back View

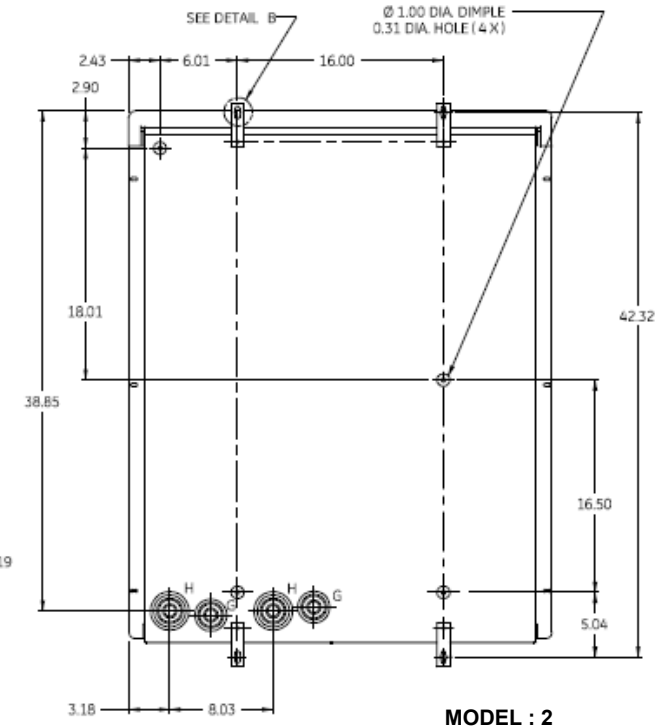

Detail A

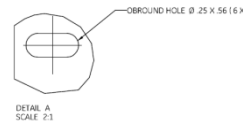

Detail B

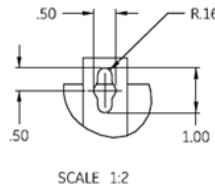

Bottom View

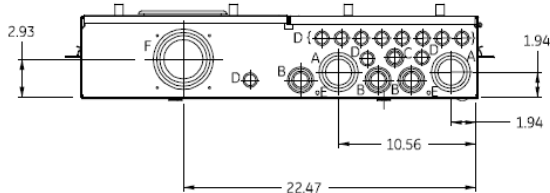

Note : All Dimensions have ±0.125 Tolerance

LETTER	DESCRIPTION	QTY
A	1 1/2 x 2 x 2 1/2 KO	2
B	3/4 x 1 x 1 1/4 x 1 1/2 KO	3
C	1/2 x 3/4 x 1 KO	1
D	1/2 x 3/4 KO	11
E	9/32 KO	2
F	2 1/2 x 3 x 3 1/2 x 4 KO	1
G	1/2 x 3/4 x 1 1/4 x 1 1/2 x 2 KO	2
H	1/2 x 3/4 x 1 1/4 x 1 1/2 x 2 x 2 1/2 KO	2



Main Breaker Dual A2A - Ringless - 400A -10K-24/40 Circuits N3R Encl - SBS - Semiflush Front - Lever Bypass-UG Incoming Feed - EUSERC

CAT NO	DWG DATE	REV #
TM2440RMRS	11/27/2020	01