

Side View

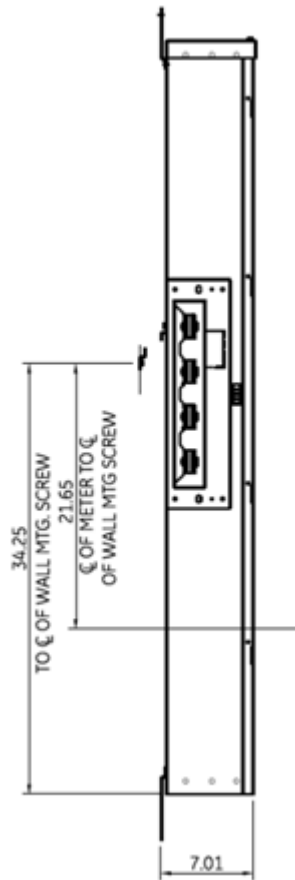

Front View

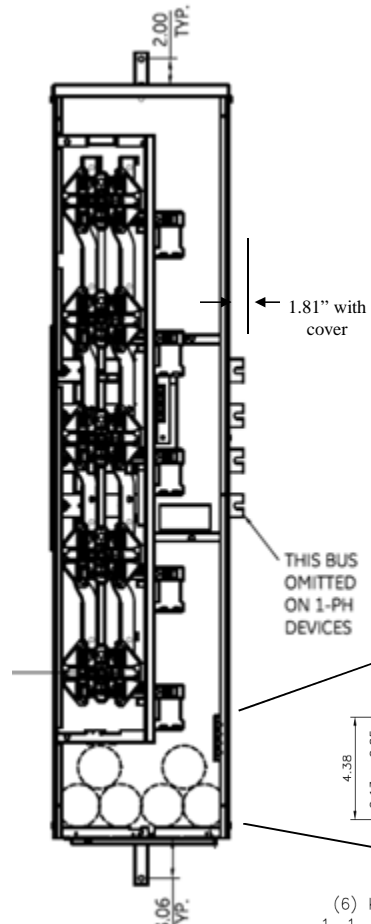

Front Layout View

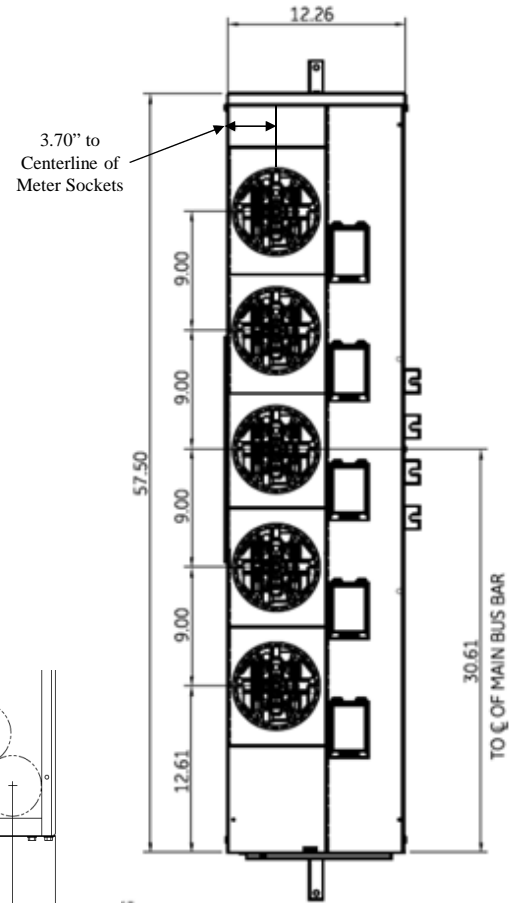

Top view has blank end walls (no knockouts)

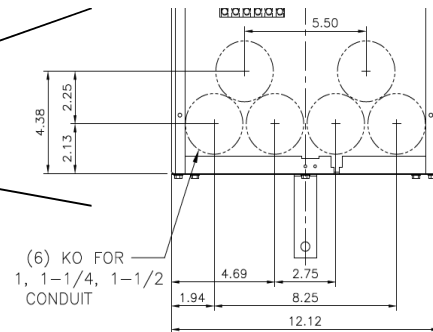

(6) KO FOR
1, 1-1/4, 1-1/2
CONDUIT

Bottom View

Z=C OF 1-1/2" RING
Y=C OF 1-1/4" RING
X=C OF 3/4" & 1" RING

TANGENTIAL K.O.'S
3/4, 1, 1-1/4, 1-1/2

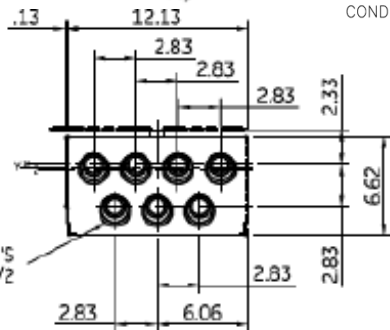

imagination at work

METER MOD III – 1PH 1200A HORIZONTAL BUSSING
(5) 125A RING SOCKETS – N3R ENCLOSURE

REF NO	CAT NO	DWG DATE	REV #
96-4356	TMP12512R	1/8/2015	01